

POLARIS **RANGER**



2025

**ACCESSORIES,
MAINTENANCE & APPAREL**

EMEA VERSION

HARDEST WORKING. SMOOTHEST RIDING.

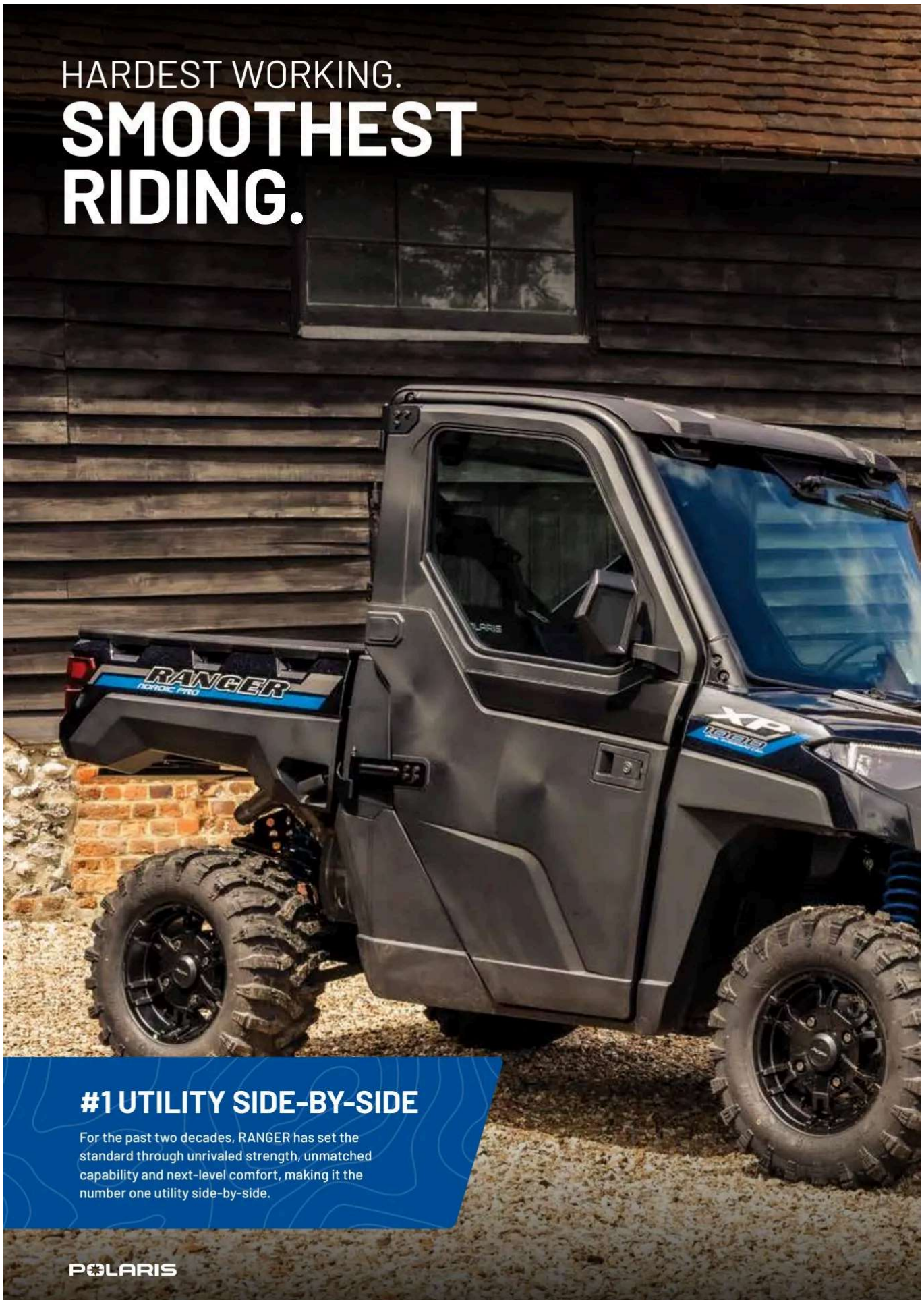

#1 UTILITY SIDE-BY-SIDE

For the past two decades, RANGER has set the standard through unrivaled strength, unmatched capability and next-level comfort, making it the number one utility side-by-side.

POLARIS



POLARIS RANGER

12 1000 / XP 1000 / XP KINETIC

- 18 CAB KITS & ROOFS
- 20 WINDSHIELDS & REAR PANELS
- 22 CAB COMFORT & CONVENIENCE
- 25 WINCHES
- 26 PROTECTION
- 28 AUDIO
- 32 STORAGE
- 38 XP KINETIC ACCESSORIES
- 40 MAINTENANCE PARTS & FLUIDS

42 SP 570

- 44 ROOFS
- 46 WINDSHIELDS & REAR PANELS
- 48 CAB COMFORT & CONVENIENCE
- 49 AUDIO & WINCHES
- 50 STORAGE
- 51 PROTECTION
- 52 MAINTENANCE PARTS & FLUIDS

54 YOUTH

56 COMMON ACCESSORIES

- 56 WINCHES
- 58 PLOWS
- 62 LIGHTING
- 64 CONNECTED TECHNOLOGY
- 66 ELECTRICAL ACCESSORIES
- 69 TRACKS
- 70 HUNT
- 72 COOLERS
- 74 WHEELS & TIRES
- 106 CLEANERS & TRAILERING

84 MAINTENANCE & GARAGE

- 84 OIL & LUBRICANTS
- 112 JUMP STARTERS & SERVICE PARTS

88 APPAREL

- 89 RANGER APPAREL & MERCHANDISE
- 89 RANGE COLLECTION
- 90 RACING COLLECTION
- 92 CASUALWEAR & HATS
- 93 HOME & COLLECTIBLES
- 94 HELMETS & GOGGLES

IMPORTANT: Adding accessories may impact the vehicle's conformity to its homologation or type approval. Polaris recommends consulting with local authorities and/or your local dealer to understand the requirements and restrictions related to the installation of accessories on your vehicle.

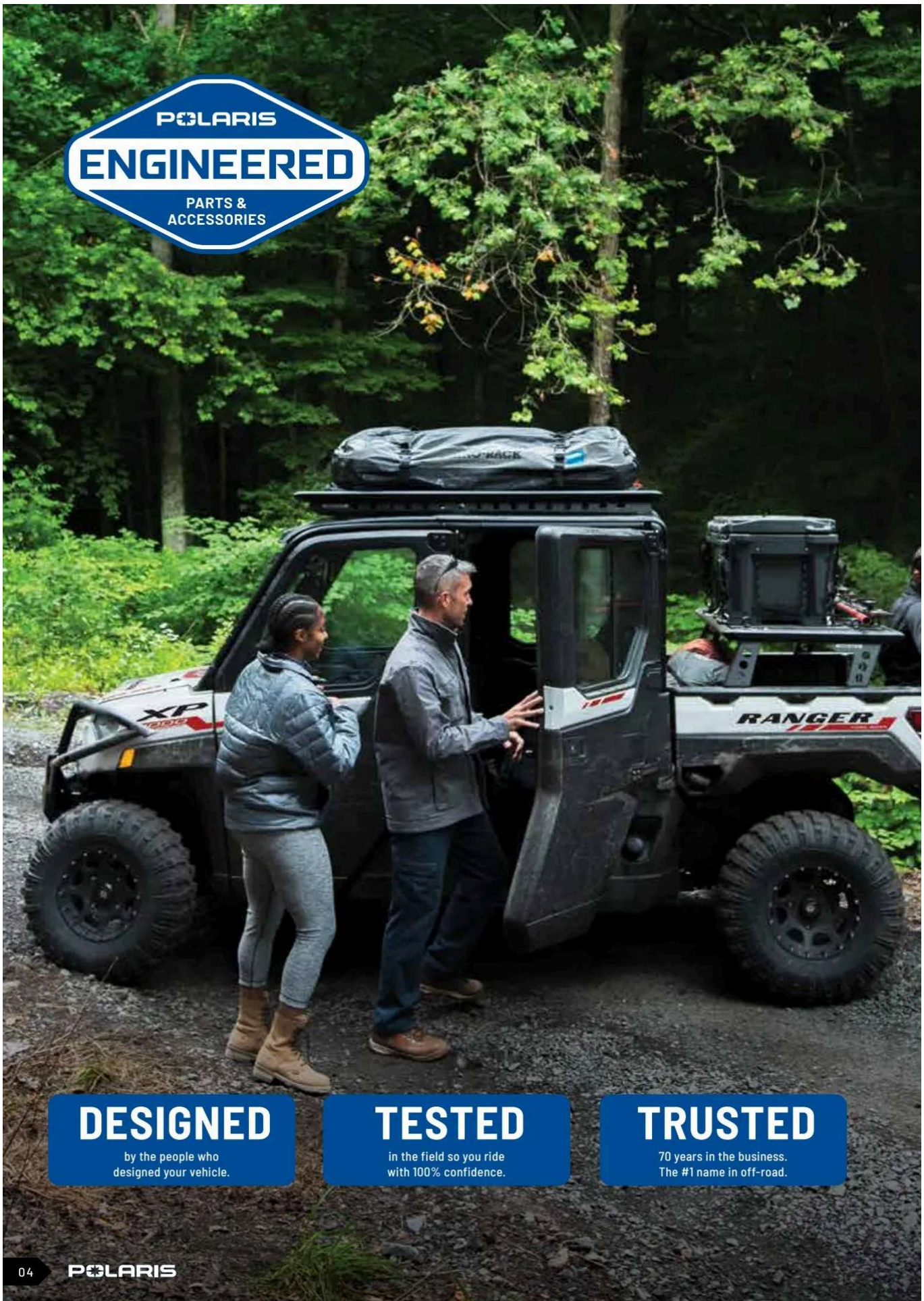

DESIGNED
by the people who designed your vehicle.

TESTED
in the field so you ride with 100% confidence.

TRUSTED
70 years in the business. The #1 name in off-road.



KEEP YOUR
STANDARDS HIGH.
 WE DO.



WE HOLD OUR PARTNERS
 TO THE SAME STANDARDS

Sharing an outdoor adventure with a companion or two gives your experience its very own energy. When we meet another brand that builds and tests their products with the same rigor as we do, a kinship forms. So we give them an exclusive partner badge and invite them along for the ride. It's another way we bring you the best options for customizing your Polaris vehicle without compromise. How better to send you and your crew out into the world?





**BRING IT ALL.
BRING IT ON.**

SEE RHINO-RACK® PRODUCTS P. 32



**RANGER XP KINETIC
GET MORE DONE.
HAVE MORE FUN.**





NEXT-LEVEL COMFORT

LEVERAGE THE FULL CAPABILITIES OF YOUR MACHINE YEAR-ROUND.

PRO SHIELD
CAB SYSTEMS



SUPERIOR INTEGRATION

MAKE WORK EASIER WITH YOUR VEHICLE BUILT TO ADD ESSENTIAL ACCESSORIES FOR ANY JOB.

PRO HD SERIES
HEAVY DUTY WINCHES

GLACIER
PLOW SYSTEMS

PULSE
ELECTRICAL SYSTEM



DO MORE

TACKLE ANY JOB AND LEAVE NOTHING BEHIND.

LR LOCK & RIDE

LR LOCK & RIDE MAX

RHINO-RACK

HARDEST WORKING, SMOOTHEST RIDING

RANGER IS A TRUSTED, MOST CAPABLE, WORK PARTNER.
Developed and tested along with the vehicle, Polaris Engineered Accessories are designed for seamless integration and simple installation to get more done, year-round.

SUPERIOR INTEGRATION

PULSE
ELECTRICAL SYSTEM P. 66

PLUG AND PLAY ELECTRICAL

A revolution in electrical accessory integration, the Polaris PULSE Electrical System allows for a simple plug and play approach for adding power to Polaris Engineered Accessories.

PRO HD SERIES
HEAVY DUTY WINCHES P. 56

INTEGRATED PRE-WIRED WINCH MOUNT

Designated mounting points and pre-wired connectors provide a perfect fit and the strongest place to attach the Polaris Engineered winch - the most dependable winch for your RANGER. With wiring built right into the vehicle, we made this the easiest RANGER winch to install.

GLACIER
PLOW SYSTEMS P. 58

INTEGRATED PLOW MOUNT*

The attachment points for the Glacier Plow System are integrated right at the factory and feature an innovative drive-up and go installation process.

*Integrated plow mount not included on RANGER SP 570 non-Premium/non-NorthStar models





DO MORE



VERSATILITY

Lock & Ride mounting locations allow for limitless customization to let you work the way you want.

RANGER 1000 / XP 1000 / XP KINETIC / DIESEL P. 20
RANGER SP 570 P. 46

BRING IT ALL. BRING IT ON.*



STORAGE VERSATILITY

Rhino-Rack roof rack and bed rack solutions offer 40% more storage capacity so you never have to leave tools or gear behind.



RANGER 1000 / XP 1000 / XP KINETIC / DIESEL P. 32

*Always read and follow the owner's manual and on-vehicle labels for prohibited items.

SUPERIOR INTEGRATION

PRO HD SERIES HEAVY DUTY WINCHES



HD SERIES HEAVY DUTY WINCHES



LEARN MORE P. 56

POLARIS ENGINEERED WINCH FEATURES



Tested **1,200+** pulls at max load, it works when you need it to



Built to withstand **-29° C** temperatures



Sealed motor & heavy duty gears **OPERATE FULLY SUBMERGED UNDERWATER**



MILITARY tested & approved





RIGHT FROM THE FACTORY, your vehicle is built to make essential accessories like winches and plows easy to use day-in and day-out. Mounting brackets are designed into the oversized factory bumper and wiring is routed securely and properly. When it comes to RANGER, Polaris Engineered Accessories make work easier so you can get more done.

PRE-WIRED CHASSIS

Dash mounted controls and wiring are installed at the factory. Mount the winch, connect the wires and trust that everything is routed safely, securely, and properly.

NO CUTTING OR DRILLING REQUIRED

FULLY INTEGRATED MOUNT & WIRING

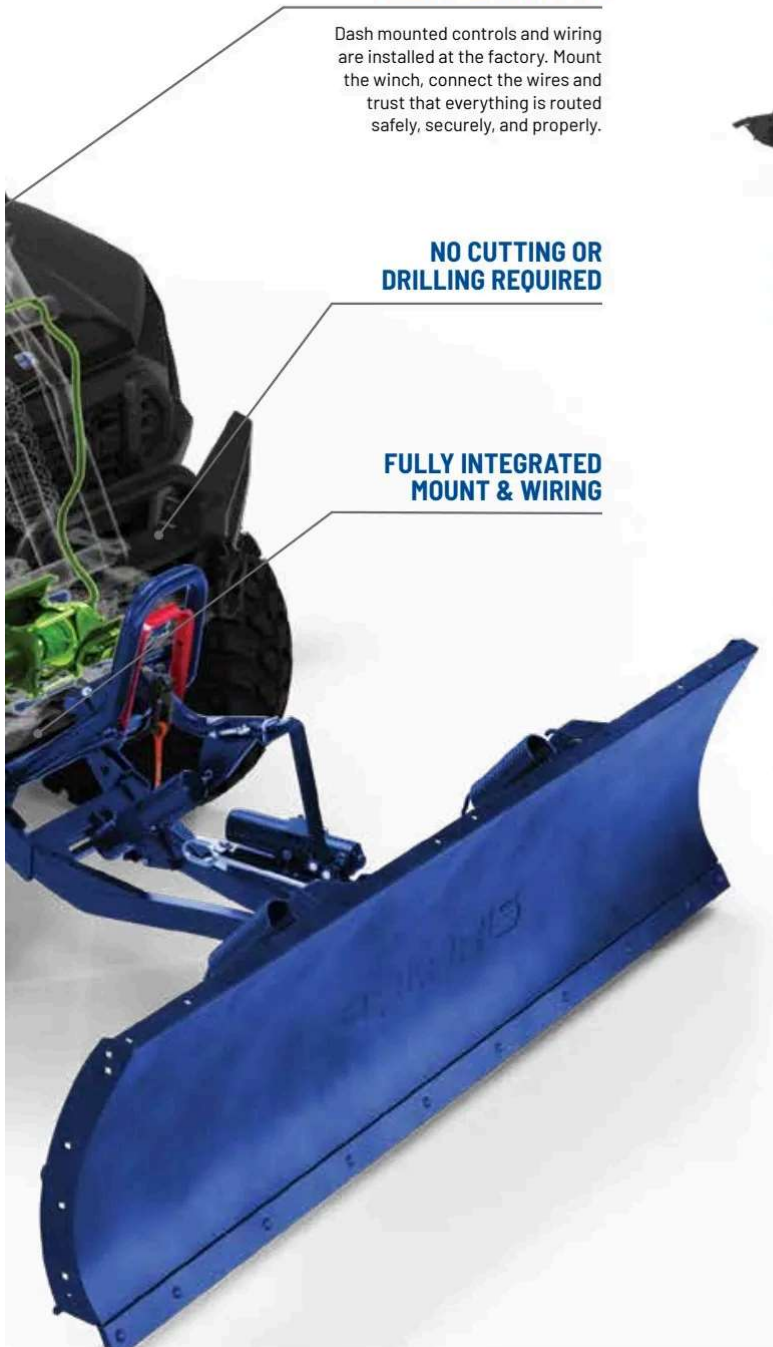





GLACIER PLOW SYSTEMS

LEARN MORE P. 58



GLACIER FEATURES

-  To install the plow, simply lift the mount lock handle and pull forward
-  No loss of factory ground clearance when not plowing
-  Don't have to crawl under the machine to release the plow blade from the vehicle
-  No trimming of vehicle plastic or fascia required to mount plow or winch
-  Angle your blade right from your seat with the Glacier Pro Plow Hydraulic Angle System
-  Angle your blade 25° left and right, conveniently from your seat



RANGER 1000 / XP 1000 / XP KINETIC / DIESEL

CUSTOMIZE YOUR RANGER

MAXIMIZE YOUR EXPERIENCE

COMPRISED OF TOP SELLING ACCESSORIES FOR YOUR MODEL,

The Owners Essentials Package is a great place to start accessorizing your RANGER.



OWNER ESSENTIALS PACKAGE

- | | | | |
|---------|---|---------|------------------------------|
| 2889021 | Full Glass Windshield - Clear † P. 20 | 2890232 | Upper Front Brushguard P. 26 |
| 2879013 |  Rear Panel - Glass* P. 21 | 2882529 | Rear Brushguard P. 26 |
| 2890288 | Sun Visor P. 23 | 3211186 | ORV Drive Belt P. 40 |
| 2889220 | Weatherproof Convex Rearview Mirror Kit* P. 23 | | |



SHOP BY USE

PACKAGES MADE FOR THE WAY YOU RANGER

ADD ON TO THE OWNER ESSENTIALS PACKAGE TO CUSTOMIZE FOR HOW YOU USE YOUR RANGER.



FARM/RANCH PACKAGE

2882752  Bed Extender/Divider P. 34

2890233  Headache Rack P. 34

2883127 RIGID® D-Series PRO Spot LED Light P. 62

2884299 RIGID® 81 cm Combo LED Light Bar P. 63

2883230 Polaris PULSE Wiring Harness - 1 LED Light P. 68

2890904 Pro Armor Wheel & Tire Set: 4202 & Trekker, 29" P. 105

1000 / XP 1000 / XP KINETIC / DIESEL

CAB RIMS & ROOFS

WINDSHIELDS & REAR PANELS

CAB COMFORT & CONVENIENCE

WINCHES

PROTECTION & AUDIO

STORAGE

XP KINETIC

MAINTENANCE PARTS & FLUIDS

RANGER 1000 / XP 1000 / XP KINETIC / DIESEL



TRAIL RIDING PACKAGE

- 2882530 Rock Guard with Step - 3-Seat P. 26
- 2889689 Mud Guards P. 26
- 2890226 JBL® Rear Speakers & Sub P. 29
- 2889193  Spare Tire Carrier P. 34

- 2883122 RIGID® SR-Series 25 cm Flood LED Light P. 62
- 2883230 Polaris PULSE Wiring Harness - 1 LED Light P. 68
- 2883425 Polaris NorthStar 57 L Cooler P. 72
- 2890904 Pro Armor Wheel & Tire Set: 4202 & Trekker, 29" P. 105



WINTER PACKAGE

- 2889058 Glacier Pro HD Plow Hydraulic Lift System P. 58
- 2889328 Glacier 15.3 cm Plow Extensions P. 58
- 2889308 Glacier Pro HD Plow Frame P. 58
- 2879317 Glacier Pro HD Plow Blade - 183 cm Poly P. 82

- 2889029 Glacier PRO HD Plow Hydraulic Angle System P. 58
- 2883247 Glacier Plow System Power Controller P. 58
- 2889329 Glacier Plow Back Drag Bar P. 83
- 2889793 Pro Armor 102 cm Single-Row Combo LED Light Bar P. 63



LANDOWNER PACKAGE

- 2882177 CargoMax System P. 34
- 2889876 Trash Can Hauler P. 37

- 2889793 Pro Armor 102 cm Single-Row Combo LED Light Bar P. 63
- 2883230 Polaris PULSE Wiring Harness - 1 LED Light P. 68



HUNT PACKAGE

- 2882904 PULSE Roof Busbar with Hardware P. 31
- 2890583 Front Hood Storage Rack P. 34
- 2889705 300 Lb. Cargo Bed Rear Winch P. 34
- 2890233 Headache Rack P. 34

- 2883970 Kolpin Stronghold® Auto-Latch Double Gun Boot Mount P. 70
- 2882036 Kolpin Stronghold Gun Boot XL P. 70
- 2884107 Kolpin Rhino Grip® Pro P. 71
- 2883151 Pro Armor Wheel & Tire Set: 4204 & Dual-Threat, 29" P. 80

- 1000 / XP 1000 / XP KINETIC / DIESEL
- CAB KITS & ROOFS
- WINDSHIELDS & REAR PANELS
- CAB COMFORT & CONVENIENCE
- WINCHES
- PROTECTION & AUDIO
- STORAGE
- XP KINETIC
- MAINTENANCE PARTS & FLUIDS

RANGER 1000 / XP 1000 / XP KINETIC / DIESEL

CAB KITS

TAKE YOUR
2025 RANGER
TO THE NEXT LEVEL OF COMFORT

Customize your experience by adding Cab Kits.





1000 / XP 1000 / XP KINETIC / DIESEL

CAB KITS & ROOFS

WINDSHIELDS & REAR PANELS

CAB COMFORT & CONVENIENCE

WINDCHES

PROTECTION & AUDIO

STORAGE

XP KINETIC

MAINTENANCE PARTS & FLUIDS

FULL CAB KITS 1000 / XP 1000 / DIESEL / XP KINETIC			PREMIUM 28K0001	FS NORDIC PRO - DIESEL DELUXE TRACTOR 28K0010	XP 1000 TRACTOR 28K0011	1000 TRACTOR 28K0012	DIESEL TRACTOR 28K0013	XP KINETIC TRACTOR 28K0014
2890684	Premium Roof - Poly - Black	P.18	✓	✓	✓	✓	✓	✓
2889020	Tip-Out Full Windshield - Glass	P.20	✓	✓	✓	✓	✓	✓
2879013	Rear Panel - Glass	P.21	✓	✓	✓	✓	✓	✓
2889811-070	Manual Crank Window Doors - Poly - Black		✓	✓	✓	✓	✓	✓
2883974	Windshield Wiper & Washer System	P.22	✓	✓	✓	✓	✓	✓
2209164	Mirror Door Mount Adaptors	P.23	✓	✓	✓	✓	✓	✓
2891398	Labels & Covers Kit			✓	✓	✓	✓	✓
PN Varies	8-Vent Heater & Defrost System	P.22-23			2882753	2884066	2890045	2889449

HALF CAB KIT 28K0003

- 2890684 Premium Roof - Poly - Black P. 18
 - 2889021 Fixed Windshield - Glass P. 20
 - 2879013 Rear Panel - Glass P. 21
 - 2883974 Windshield Wiper & Washer System P. 22
- XP 1000 '18-25, 1000 '20-25, DIESEL '20-25, XP KINETIC '23-24



8-VENT HEATER & DEFROST SYSTEM TM P. 22-23

- » **TOP SELLER** 2882753 **XP 1000 ONLY**
XP 1000 '18-22
- » **TOP SELLER** 2884066 **1000 ONLY**
1000 '20-22
- » **TOP SELLER** 2890045 **DIESEL ONLY**
DIESEL '20-22
- » **TOP SELLER** 2889449 **XP-KINETIC ONLY**
XP-KINETIC '23-24



**ADD TO YOUR
CAB COMFORT**
with the Heater System

RANGER 1000 / XP 1000 / XP KINETIC / DIESEL

ROOFS

TO SHIELD AGAINST DRIVING RAIN OR THE BLISTERING SUN, a roof is the first must-have of the Polaris Engineered cab components. Get on your way with protective peace of mind.



POLY FEATURES

- Water run-off
- Liner ready
- Polaris PULSE plug and play
- Lightweight

POLY

Lightweight, durable and impact-resistant. A poly roof can take the abuse of a tough trail and still protect.

LINERS

Get a touch of premium comfort, reduce cab noise and hide wiring.

Included with Premium Poly Roofs.

PRO SHIELD CAB SYSTEMS

PREMIUM ROOF - POLY

- » POLARIS PURSUIT CAMO • 2882913
- XP 1000 '17-25, 1000 '20-25, XP KINETIC '23-24, DIESEL '17-25
- INCLUDES ROOF LINER



PRO SHIELD CAB SYSTEMS

SPORT ROOF - POLY

- » BLACK • 2882911
- XP 1000 '17-25, 1000 '20-25, XP KINETIC '23-24, DIESEL '17-25



PRO SHIELD CAB SYSTEMS

NEW! PREMIUM ROOF - POLY TOP SELLER

- » BLACK • 2890684
- XP 1000 '17-25, 1000 '20-25, XP KINETIC '23-24, DIESEL '17-25



PRO SHIELD CAB SYSTEMS

PREMIUM ROOF LINER

- » 2890526
- XP 1000 '17-25, 1000 '20-25, XP KINETIC '23-24, DIESEL '17-25
- WORKS WITH 2882911



POLARIS ENGINEERED ADVANTAGES



PREMIUM FINISH AND QUIETER RIDE



SEALED COVERAGE



REDUCE STANDING WATER



EASY AND FAST INSTALLATION

PREMIUM & SPORT ROOF FEATURES*

SEE AUDIO OPTIONS P. 28
ADD POWER TO PREMIUM & SPORT ROOFS P. 66



* Premium and Sport features not available on steel roofs



PRO SHIELD CAB SYSTEMS
SPORT ROOF CREW - POLY TOP SELLER
» BLACK • 2890333
CREW XP 1000 '18-25, CREW 1000 '20-25



PRO SHIELD CAB SYSTEMS
PREMIUM ROOF LINER - CREW TOP SELLER
» 2890527
CREW XP 1000 '18-25, CREW 1000 '20-25

RANGER 1000 / XP 1000 / XP KINETIC / DIESEL

WINDSHIELDS & REAR PANELS

GLASS vs HARD COAT POLY

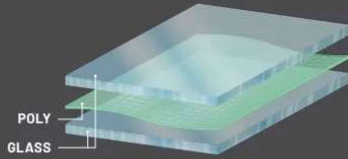

Superior optical clarity (automotive level)
 Scratch-resistant
 Curved to fit, seals tight
 Cold weather / heavy duty
 Wiper ready

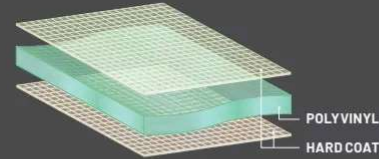

Lightweight, flexible, easy to store/remove
 Impact-resistant
 360° seal keeps out rain and dust



PRO SHIELD CAB SYSTEMS

TIP-OUT FULL WINDSHIELD - GLASS TOP SELLER

- Tip-out design offers three positions: open, closed and vented
- Gas shocks assist in easy opening and closing
- 360° gasket for reliable protection and comfort
- Scratch-resistant automotive-style curved glass

» 2889020

XP 1000 '18-25, CREW XP 1000 '19-25, CREW 1000 '20-25, 1000 '20-25, XP KINETIC '23-24, DIESEL '20-25
 NOT COMPATIBLE WITH ROPS MOUNTED SIDE VIEW MIRRORS (2889243)



PRO SHIELD CAB SYSTEMS

FULL GLASS WINDSHIELD - CLEAR

- Scratch-resistant, curved laminate safety glass
- Protects against wind and rain
- UV-blocking interlayer and 360° gasket seal

» 2889021

XP 1000 '18-25, CREW XP 1000 '19-25, CREW 1000 '20-25, 1000 '20-25, XP KINETIC '23-24, DIESEL '20-25



FULL GLASS WINDSHIELD - CLEAR

- Scratch-resistant, curved laminate safety glass that protects against wind, rain and other hazardous debris
- UV-blocking interlayer and 360° gasket seal
- Seal Kit included

» 2889030

XP 1000 '17-25, CREW XP 1000 '17-25, CREW 1000 '20-25, 1000 '20-25, DIESEL '17-25



PRO SHIELD CAB SYSTEMS



FULL WINDSHIELD VENTED - HARD COAT POLY

- Frameless design for maximum visibility
- Added vents for airflow on a hot day or defrosting on a cold day
- Requires Wiper Install Kit (2207624), sold separately

» 2883266

XP 1000 '17-25, CREW XP 1000 '18-25, CREW 1000 '20-25, 1000 '20-25, XP KINETIC '23-24, DIESEL '20-25



PRO SHIELD CAB SYSTEMS



FULL WINDSHIELD - HARD COAT POLY

- Frameless design for maximum visibility
- Requires Wiper Install Kit (2207624), sold separately

» 2883300

XP 1000 '17-25, CREW XP 1000 '18-25, CREW 1000 '20-25, 1000 '20-25, XP KINETIC '23-24, DIESEL '20-25



PRO SHIELD CAB SYSTEMS

FLIP-DOWN WINDSHIELD - HARD COAT POLY

- Two venting options: fully sealed, flip-down or remove upper half for some protection with maximum ventilation

» 2884139

XP 1000 '18-25, CREW XP 1000 '19-25, CREW 1000 '20-25, 1000 '20-25, XP KINETIC '23-24, DIESEL '20-25



POLARIS ENGINEERED ADVANTAGES

EASY AND FAST INSTALLATION

AIRTIGHT GASKET SEAL

MULTI-FUNCTION FEATURES



PRO SHIELD CAB SYSTEMS

LR FULL WINDSHIELD - POLY

- Frameless design for maximum visibility

» 2883278

XP 1000 '17-25, CREW XP 1000 '18-25, CREW 1000 '20-25, 1000 '20-25, XP KINETIC '23-24, DIESEL '20-25



LR HALF WINDSHIELD - POLY

- Deflects air flow from straight on, but still provides air flow in the cab

» 2883301

XP 1000 '17-25, CREW XP 1000 '18-25, CREW 1000 '20-25, 1000 '20-25, XP KINETIC '23-24, DIESEL '20-25



ADD ALL-WEATHER VISIBILITY

P. 22

REAR PANELS

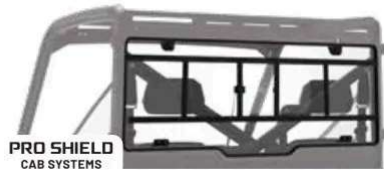

PRO SHIELD CAB SYSTEMS

LR REAR PANEL - SLIDING GLASS

- Sliding window provides ventilation, cab comfort and access to cargo in rear box

» 2879015

XP 1000 '17-25, CREW XP 1000 '18-25, CREW 1000 '20-25, 1000 '20-25, XP KINETIC '23-24, DIESEL '20-25



PRO SHIELD CAB SYSTEMS

LR REAR PANEL - GLASS TOP SELLER

» 2879013

XP 1000 '17-25, CREW XP 1000 '18-25, CREW 1000 '20-25, 1000 '20-25, XP KINETIC '23-24, DIESEL '20-25

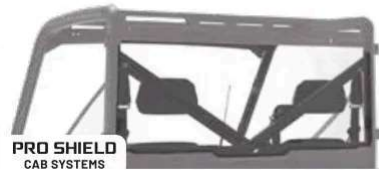

PRO SHIELD CAB SYSTEMS

LR REAR PANEL - POLY

- Strong, thick polycarbonate provides outstanding impact and scratch resistance
- Installs in contours of cab frame with 360° gasketing for outstanding protection, comfort, fit and finish

» 2883773

XP 1000 '17-25, CREW XP 1000 '18-25, CREW 1000 '20-25, 1000 '20-25, XP KINETIC '23-24, DIESEL '20-25

REDUCE IN-CAB DUST SWIRL BY ADDING A REAR PANEL.

With a windshield and roof installed, turbulent air develops behind the cab. Add a rear panel to reduce dust intrusion from this swirl.

RANGER 1000 / XP 1000 / XP KINETIC / DIESEL

CAB COMFORT & CONVENIENCE



UNDER SEAT DRY STORAGE XP 1000 ONLY

» 2882910
 XP 1000 '18-25, CREW XP 1000 '19-25, XP KINETIC '23-24, DIESEL '20-25
 WILL NOT WORK WITH SUBWOOFER 2882890 & 2884233



8-VENT HEATER & DEFROST SYSTEM TOP SELLER P

- Easily control the climate inside your cab in any season
- Helps defrost windshields and keeps you warm or cool
- Heat and fan dash-mounted controls
- Manual vents

» 2882753 XP 1000 ONLY
 XP 1000 '18-25, CREW XP 1000 '19-25

» 2884066 1000 ONLY
 CREW 1000 '20-25, 1000 '20-25
 NEED ADAPTER: 2884163 ON CREW 1000

» 2890045 DIESEL ONLY
 DIESEL '20-25

» CREW HEATER ADAPTER KIT 1000 ONLY
 2884163
 CREW 1000 '20-25



WINDSHIELD WIPER & WASHER SYSTEM TOP SELLER P

» 2883974
 XP 1000 '18-25, CREW XP 1000 '19-25, CREW 1000 '20-25, 1000 '20-25, XP KINETIC '23-24, DIESEL '20-25
 HARD COAT POLY WINDSHIELDS REQUIRE MOUNT KIT (2207824), SOLD SEPARATELY

HARD COAT POLY WINDSHIELD WIPER & WASHER SYSTEM MOUNTING BRACKET

» 2207624
 XP 1000 '17-25, CREW XP 1000 '18-25, CREW 1000 '20-25, 1000 '20-25, XP KINETIC '23-24, DIESEL '20-25
 REQUIRED TO USE WIPER ON POLY WINDSHIELDS (2883266 OR 2883300)



FLOOR MATS - 3 SEAT

» 2882780 XP 1000 ONLY
 XP 1000 '18-25, CREW XP 1000 '19-25, XP KINETIC '23-24, DIESEL '20-25
 CREW: FITS FRONT SEATS ONLY

» 2884247 1000 ONLY
 CREW 1000 '20-25, 1000 '20-25
 CREW: FITS FRONT SEATS ONLY

NOISE REDUCTION SYSTEM

- Designed to attach to the rear closure panel of your RANGER cab
- The sound absorbing material reduces unwanted noise for a quieter cab

» 2883489
 XP 1000 '18-25, CREW XP 1000 '19-25, 1000 '20-25, CREW 1000 '20-25, XP KINETIC '23-24, DIESEL '20-25

FRONT BUMPER ACCENT LIGHT & HARNESS

- Provides an additional 1,200 Lumens of front illumination
- Seamlessly integrate into your bumper pockets
- Easily control the lighting for enhanced visibility and style with a dash-mounted switch

» 2890440
 XP 1000 '25, CREW XP 1000 '25, DIESEL '20-25
 NOT AVAILABLE IN EUROPE





FULL-SIZE SEATSAVER® - SPLIT BENCH SEAT XP-1000 ONLY

- Covers the back and bottom of seat
- Designed to fit snug and stay wrinkle free, so it won't slip, slide, or bunch up
- Machine washable for easy cleaning

■ **CARHARTT® GRAVEL • 2890291-458**

XP 1000 '18-21, CREW XP 1000 '19-21, XP KINETIC '23-24, DIESEL '20-25
CREW: FITS FRONT SEATS ONLY
NO REAR SEAT COVERS AVAILABLE



SEAT CONFIGURATION

CAB KITS & ROOFS

WINDSHIELDS & REAR PANELS

CAB COMFORT & CONVENIENCE

WINDCHES

PROTECTION & AUDIO

STORAGE

XP KINETIC

MAINTENANCE PARTS & FLUIDS



REMOTE GARAGE DOOR OPENER BY HOMELINK NEW

- Control up to two garage doors

» **2882892**

XP 1000 '18-25, CREW XP 1000 '19-25, CREW 1000 '20-25, 1000 '20-25, XP KINETIC '23-24, DIESEL '20-25



IN-CAB HEATER AND DEFROST KIT TOP SELLER NEW

- Easily control the climate inside your cab in any season
- Helps defrost windshields and keep you warm or cool
- Three different fan speeds
- Heat and fan dash-mounted controls
- Manual vents

» **2889449**

XP KINETIC '23-24
REQUIRES HIGH VOLTAGE BUSBAR (2889667) AND ADHESIVE ACCESSORY KIT (2890070), EACH SOLD SEPARATELY



12V CARGO BED POWER KIT NEW

- Additional power for your tools or accessories
- Requires 12V In-Bed Power Harness Extension (2890068), sold separately

» **2889673**

XP 1000 '18-25, CREW XP 1000 '18-25, 1000 '20-25, CREW 1000 '20-25, DIESEL '20-25
REQUIRES 12V IN-BED POWER HARNESS EXTENSION (2890068), SOLD SEPARATELY



SIDE VIEW MIRRORS

- Mounts on any RANGER vehicle that is equipped with doors
- Fully adjustable to accommodate riders of all sizes and can fold in to prevent being struck

» **DOOR MOUNTED • 2889241**

NOT COMPATIBLE WITH DOORS 2883229, 2882901, 2882902, 2882903

» **ROPS-MOUNTED (SHOWN) • 2889243**

XP 1000 '18-25, CREW XP 1000 '19-25, CREW 1000 '20-25, 1000 '20-25, XP KINETIC '23-24, DIESEL '20-25

NOT COMPATIBLE WITH TIP-OUT WINDSHIELD (2889020), DOORS OR UNITS WITH A FORWARD GRIP HANDLE ON THE ROPS

» **DOOR MOUNT ADAPTOR • 2209164**

ONLY NEEDED TO MOUNT 2889243 ON DOORS



WEATHERPROOF CONVEX REARVIEW MIRROR KIT TOP SELLER

» **2889220**

XP 1000 '17-25, CREW XP 1000 '18-25, CREW 1000 '20-25, 1000 '20-25, XP KINETIC '23-24, DIESEL '20-25



WIDE ANGLE REAR VIEW MIRROR

- Large 6.4 x 35.6 cm adjustable convex mirrored surface gives you a full-spectrum view

» **2881439**

XP 1000 '17-25, CREW XP 1000 '18-25, CREW 1000 '20-25, 1000 '20-25, XP KINETIC '23-24, DIESEL '20-25



12V IN-BED POWER HARNESS EXTENSION

- Required for Installation of 12V Cargo Bed Power Kit (2889673)

» **2890068**

CREW XP 1000 '18-25, CREW 1000 '20-25, DIESEL '20-25



UPPER SWITCH PANEL NEW

- Add up to 4 additional electrical accessory switches
- Convenient roof-mounted overhead panel
- Includes mounting hardware

» **2889674**

XP 1000 '18-25, CREW XP 1000 '18-25, 1000 '20-25, CREW 1000 '20-25, DIESEL '20-25
REQUIRES UPPER SWITCH PANEL LIGHT BAR HARNESS (2889675), SOLD SEPARATELY



SUN VISOR TOP SELLER

- Injection molded visors for seamless fit to protect from the sun

» **2890288**

XP 1000 '17-25, CREW XP 1000 '18-25, CREW 1000 '20-25, 1000 '20-25, XP KINETIC '23-24, DIESEL '20-25

RANGER 1000 / XP 1000 / XP KINETIC / DIESEL

CAB COMFORT & CONVENIENCE

WORK BEACON LED LIGHT

- 15.2 m of illumination 360° around your vehicle
- Ideal for plowing, hunting and nighttime utility work
- Break-away construction protects the light in areas with tight clearance
- Mounted to the vehicle on the rear of the ROPS
- Easily hinge the light up during use and hinge it down when in transit
- Add LED Headlights for more light

» 2883285

XP 1000 '18-25, CREW XP 1000 '19-25, CREW 1000 '20-25, 1000 '20-25, XP KINETIC '23-24

REQUIRES LIGHT BAR HARNESS/EXTENSION (2883230 AND 2883854), EACH SOLD SEPARATELY
NOT AVAILABLE IN EUROPE



MULTI-FUNCTION CAB LIGHT

- LED dome light provides white, red, green and blue lighting options
- Battery-operated. Recharges when the vehicle is on
- Can be removed to use as a flashlight in and around your vehicle

- Red light is great for reading maps
- Green light is perfect for navigating in the dark
- Blue light is ideal for night riding

» 2882871

XP 1000 '18-25, CREW XP 1000 '19-25, CREW 1000 '20-25, 1000 '20-25, XP KINETIC '23-24, DIESEL '20-25
REQUIRES POLARIS PULSE ROOF 6 (2882904), SOLD SEPARATELY
NOT AVAILABLE IN EUROPE

REAR LED WORK LIGHT

- Mounts to the back of your cab to fully illuminate the cargo box and surrounding area
- Includes necessary mounting hardware
- Requires a harness



» 2889672

XP 1000 '18-25, CREW XP 1000 '19-25, 1000 '20-25, CREW 1000 '20-25, DIESEL '20-25
CREW: REQUIRE HARNESS (2889675) AND HARNESS EXTENSION (2890067), EACH SOLD SEPARATELY

REVERSE LIGHT HARNESS

» 2889679

XP 1000 '17-25, CREW XP 1000 '18-25, CREW 1000 '20-25, 1000 '20-25, XP KINETIC '23-24, DIESEL '20-25

REVERSE WARNING ALERT

- Automatically activated whenever the vehicle is put in reverse

» 2883246

XP 1000 '18-25, CREW XP 1000 '19-25, CREW 1000 '20-25, 1000 '20-25, XP KINETIC '23-24, DIESEL '20-25
NOT AVAILABLE IN EUROPE

HORN

» 2882764

XP 1000 '18-25, CREW XP 1000 '19-25, CREW 1000 '20-25, 1000 '20-25, XP KINETIC '23-24
U.S. MODELS ONLY

UPPER SWITCH PANEL LIGHT BAR HARNESS*

- Required for Upper Switch Panel installation

» 2889675

» EXTENSION • 2890067

XP 1000 '18-25, CREW XP 1000 '19-25, 1000 '20-25, CREW 1000 '20-25, DIESEL '20-25

*Check with your local dealer for availability.



With Polaris PULSE it's easy to add all your electrical accessories.

LEARN MORE P. 66



1000 / XP 1000 / XP KINETIC / DIESEL

CAB KITS & ROOFS

WINDSHIELDS & REAR PANELS

CAB COMFORT & CONVENIENCE

WINCHES

PROTECTION & AUDIO

STORAGE

XP KINETIC

MAINTENANCE PARTS & FLUIDS

FEATURES & BENEFITS	PRO HD SERIES	HD SERIES
RAPID ROPE RECOVERY Retrieve cable 5x as fast as standard mode on other Polaris winches. Get back to riding or complete your task quicker.	✓	NOT AVAILABLE
AUTO STOP TECHNOLOGY Auto Stop technology protects and extends the life of your winch by automatically stopping the winch at the end of pull to prevent over-spooling.	✓	ADD AUTO STOP UPGRADE 2889690 <small>SYNTHETIC ROPE REQUIRED</small>
PREMIUM SYNTHETIC ROPE Lightweight, extremely strong and flexible 50 ft long rope stands up to any tough job.	✓	ADD SYNTHETIC ROPE 2879187
WIRELESS REMOTE Operate your winch wirelessly from within 50 ft of the vehicle.	✓	ADD WIRELESS REMOTE 2883455
MODEL	2,722 KG	2,041 KG
XP 1000/CREW '19-25 1000/CREW '20-25 <small>NON EPS RANGER 1000 REQUIRES FRONT BUMPER</small>	2889693	2889695
XP KINETIC '23-24 DIESEL '20-25		<small>TOP SELLER</small> 2889694 High-Mounted 2889272

UPGRADE YOUR CONTROLS
 HD OR PRO HD WINCHES

DASH WINCH SWITCH KIT

- Allows user to add a dash switch as an additional means to control winch
 - Can be used with all winches and are compatible with other control methods (wireless/wired)
- » 2889050
- XP 1000 '18-25, CREW XP 1000 '19-25, CREW 1000 '20-25, 1000 '20-25, XP KINETIC '23-24, DIESEL '20-25

TOP SELLER
POWER CONTROLLER

- Control your winch and plow hydraulics directly from the shift knob
- » 2883247
- XP 1000 '18-25, CREW XP 1000 '19-25, CREW 1000 '20-25, 1000 '20-25, DIESEL '20-25
- REQUIRES WINCH ADAPTER (2884158). SOLD SEPARATELY, WHEN USING A WINCH FOR LIFTING DEVICE

WIRED REMOTE CONTROL

- Must order remote handle and socket together
- » REMOTE HANDLE • 4013466
- » SOCKET • 4017102

REPLACEMENT PARTS

SYNTHETIC ROPE

- » 2,041 KG • 2879187
- » 2,722 KG • 2879188



RANGER 1000 / XP 1000 / XP KINETIC / DIESEL

PROTECTION



STANDARD BRUSHGUARDS TOP SELLER

- To use Front Bumper with RIDE COMMAND and Front Camera, Accessory Bumper Hardware (2207941) is required

» **FRONT • 2890232**

XP 1000 '25, CREW XP 1000 '25, DIESEL '25
FRONT BRUSHGUARD DOES NOT FIT HIGH LIFTER MODELS

» **FRONT • 2882531**

XP 1000 '18-24, CREW XP 1000 '18-24, CREW 1000 '20-25, 1000 '20-25, XP KINETIC '23-24, DIESEL '20-24
FRONT BRUSHGUARD DOES NOT FIT HIGH LIFTER MODELS

1000 NON-EPS VEHICLES REQUIRE FRONT BUMPER: 2884233

» **REAR • 2882529**

XP 1000 '18-25, CREW XP 1000 '18-25, CREW 1000 '20-25, 1000 '20-25, XP KINETIC '23-24, DIESEL '20-25

» **ACCESSORY BUMPER HARDWARE • 2207941**

FOR USE ON VEHICLES WITH RIDE COMMAND AND FRONT CAMERA

HD BRUSHGUARDS

- Increased protection over stock bumper with integrated mounting locations for accessories and lights (sold separately) with a durable matte black finish
- Easy installation with included mounting hardware
- Additional 36" storage area for recovery equipment

» **FRONT • 2885105**

XP 1000 '18-25, CREW XP 1000 '18-25, CREW 1000 '20-25, 1000 '20-25, XP KINETIC '23-24, DIESEL '20-25
FRONT BRUSHGUARD DOES NOT FIT HIGH LIFTER MODELS

» **REAR • 2884217**

REAR: RECOMMENDED WITH RIGID OR PRO ARMOR
POD LIGHTS FOR UPGRADED LIGHTING

ROCK GUARDS

ROCK GUARD WITH STEP

- Reliable, hard-working protection for edges of vehicle
- Integrated step with boot scraper helps keep interior clean
- Mounts directly to the frame, instead of underneath, for maximum ground clearance
- Steel construction with black e-coat and durable black powder-coated finish

» **TOP SELLER 3-SEAT • 2882530**

XP 1000 '18-25, 1000 '20-25, DIESEL '20-25

» **CREW • 2883398**

CREW XP 1000 '18-25, CREW 1000 '20-25

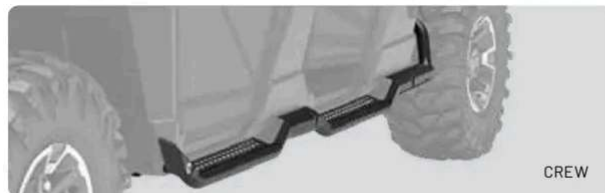

MUD GUARDS

MUD GUARDS

- Attaches under the bed to protect underside of bed, engine components and under seat area of vehicle from mud build up
- Allows for easier vehicle cleaning and less debris build up



» **RANGER 1000
2889639**
1000 '20-25,
CREW 1000 '20-25

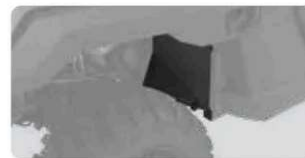

» **RANGER XP 1000
NORTHSTAR EDITION
2889689**
XP 1000 NORTHSTAR '18-25,
CREW XP 1000 NORTHSTAR '18-25



» **RANGER XP 1000
2889640**
XP 1000 '18-25,
CREW XP 1000 '18-25



HIGH-MOUNTED FRONT BRUSHGUARD

- Increased protection over stock bumper
- Offers a higher winch mounting position which allows for easier access when used in deep mud
- Not compatible with Polaris plow systems

» **2889271**

XP 1000 '18-25, CREW XP 1000 '19-25, CREW 1000 '20-25, 1000 '20-25, XP KINETIC '23-24, DIESEL '20-25
 HIGH-MOUNTED HD 2,041 KG WINCH (2889272). SOLD SEPARATELY, RECOMMENDED WHEN BRUSHGUARD IS INSTALLED

FRONT BRUSHGUARD 1000 ONLY

- Increased protection over stock bumper
- Sturdy stamped steel and tube construction
- Integrated mounting positions for plow and winch accessories

» **2889330**

CREW 1000 '20-25, 1000 '20-25
 REQUIRED TO INSTALL WINCH/PLOW ON NON EPS RANGER 1000

HIGH-MOUNTED HD 2,041 KG WINCH

- Provides outstanding performance and versatile pulling power
- The elevated mounting position allows for easier access when used in deep mud

» **2889272**

XP 1000 '18-25, CREW XP 1000 '19-25, CREW 1000 '20-21, 1000 '20-25, XP KINETIC '23-24, DIESEL '20-25



ACCESSORY BUMPER HARDWARE

- Required when using a front camera as well as an Upper Front Bumper or Hood Rack

» **2889659**

XP KINETIC '23-24



A-ARMS



HIGH CLEARANCE A-ARMS

- Valuable, reliable protection for vital front suspension components exposed to the rigors of off-road environments
- Strong, durable, lightweight polyethylene construction withstands off-road impacts to protect the A-Arms

» **FRONT • 2889269**

XP 1000 '18-25, CREW XP 1000 '19-25, CREW 1000 '20-25, 1000 '20-25, XP KINETIC '23-24

» **REAR • 2889270**

XP 1000 '18-25, CREW XP 1000 '19-25, CREW 1000 '20-25, 1000 '20-25, XP KINETIC '23-24

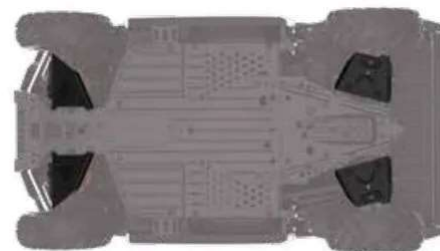

POLY A-ARM GUARDS

- Strong, .64 cm thick, durable, lightweight HMW (high molecular weight) polyethylene construction helps protect against off-road impacts
- Molded specifically for the RANGER XP 1000 & 1000 front suspension for a sure fit and low-profile presence
- Easy bolt-on design with mounting hardware included

» **FRONT • 2882784**

XP 1000 '18-25, CREW XP 1000 '19-25, CREW 1000 '20-25, 1000 '20-25, XP KINETIC '23-24, DIESEL '20-25
 WILL NOT FIT ARCHED A-ARM MODELS

» **REAR • 2882787**

XP 1000 '18-25, CREW XP 1000 '19-25, CREW 1000 '20-25, 1000 '20-25, XP KINETIC '23-24, DIESEL '20-25
 WILL NOT FIT ARCHED A-ARM MODELS

RANGER 1000 / XP 1000 / XP KINETIC / DIESEL

2025 MODELS
AUDIO



JBL® has brought music to life in a way people can feel for over 70 years. Unleash the power of music so you can live life to the fullest wherever and whenever. Purpose-built to stand up to any outdoor environment and to handle the toughest jobs.

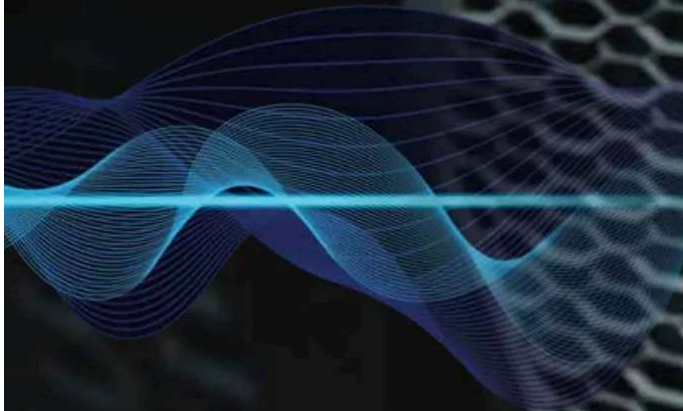

**WE PARTNERED WITH JBL® TO CREATE THE
HIGHEST PERFORMING AUDIO
SYSTEM, SPECIFICALLY
DESIGNED FOR RANGER.**



INTEGRATED KITS FOR IMMERSIVE SOUND

- 1000 / XP 1000 / XP KINETIC / DIESEL
- CAB KITS & ROOFS
- WINDSHIELDS & REAR PANELS
- CAB COMFORT & CONVENIENCE
- WINCHES
- PROTECTION & AUDIO
- STORAGE
- XP KINETIC
- MAINTENANCE PARTS & FLUIDS



NEW JBL TRAIL PRO 2000 AUDIO KIT [®]

- All-in-one solution for high performance sound
- Premium quality Bluetooth®, USB, AM/FM/WB radio
- Built-in 100 Watt four channel amplifier
- Two off-road grade 16.51 cm speakers with titanium PEI dome tweeters and polypropylene carbon fiber cones

» 2890225
 XP 1000 '25, CREW XP 1000 '25, 1000 '25, CREW 1000 '25, DIESEL '25
 COMPATIBLE WITH PREMIUM AND NORTHSTAR PREMIUM TRIMS FOR XP 1000 ONLY



NEW JBL TRAIL PRO 4100 REAR AUDIO UPGRADE [®] XP 1000 ONLY

- Upgrade kit for factory installed or accessory JBL® Trail Pro 2000 Audio Kit
- Additional speakers and subwoofers to create an immersive in-cab audio experience
- Two 16.51 cm coaxial speakers with titanium dome tweeters and 4" speakers with polypropylene cones and audio outputs to drive additional speakers
- High impact subwoofer 450 Watt and 300 watt amplifier

» 2890226
 XP 1000 '25, CREW XP 1000 '25
 COMPATIBLE WITH PREMIUM & NORTHSTAR TRIMS ONLY
 REQUIRES JBL® TRAIL PRO 2000 AUDIO KIT (2890225) OR JBL® TRAIL PRO 2000 ULTIMATE UPGRADE KIT (2890287), EACH SOLD SEPARATELY



NEW JBL® TRAIL PRO 2000 ULTIMATE UPGRADE KIT [®]

- Two 16.51 cm rear dash mounted speakers with titanium PEI dome tweeters and polypropylene carbon fiber cones
- Includes front and rear cameras, and display mount for the 7" Display powered by RIDE COMMAND
- Easy install and seamless integration
- Waterproof for reliable power and sound quality

» 2890287
 XP 1000 '25, CREW XP 1000 '25
 COMPATIBLE WITH PREMIUM & NORTHSTAR PREMIUM TRIMS ONLY



NEW 7" DISPLAY MOUNT KIT WITH CAMERAS & AUDIO [®] XP 1000 ONLY

- Mount the 7" Display powered by RIDE COMMAND, seamlessly into the dash for perfect fit and finish
- Includes mount, hardware, wiring harness and front and rear cameras

» 2890286
 1000 '25, 1000 EPS '25, DIESEL '25
 COMPATIBLE WITH PREMIUM TRIMS ONLY

RANGER 1000 / XP 1000 / XP KINETIC / DIESEL

MBQUART

2024 & OLDER MODELS

AUDIO

BUILD YOUR AUDIO SYSTEM

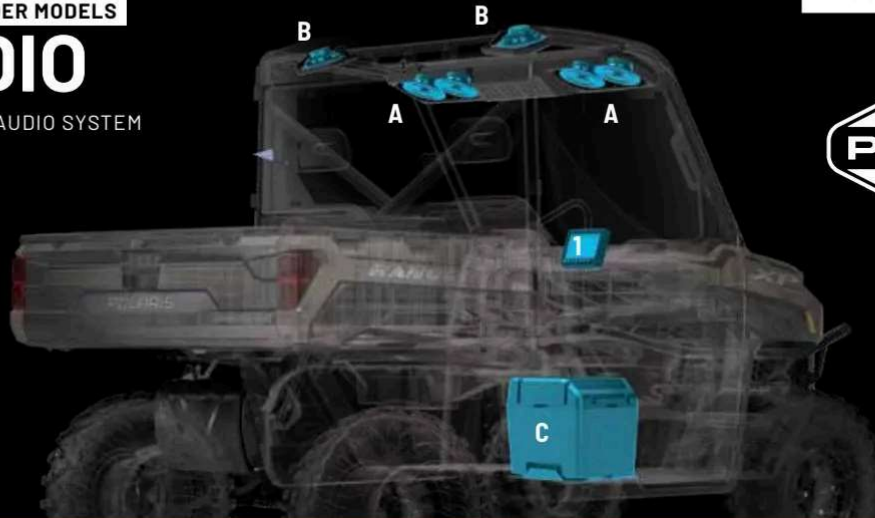

BUILD YOUR SOUND WITH RIDE COMMAND

STEP 1

ADD HEAD UNIT

7" DISPLAY POWERED BY RIDE COMMAND

2884072

SEE P. 65 FOR MORE INFORMATION

STEP 2

ADD MOUNT

2889309

XP 1000 '22-24, CREW XP 1000 '22-24,
CREW 1000 '22-24, 1000 '22-24,
DIESEL '22-24

OR

2889310

XP KINETIC '23-24

STEP 3

UPGRADE AUDIO BY ADDING VISOR OR DASH AUDIO

OPTION 1 VISOR AUDIO

A. OVERHEAD VISOR SPEAKERS

2882891†

HARNESS REQUIRED

TOP SELLER 2882904

CREW MODELS REQUIRE
ADDITIONAL 2883231

B. REAR OVERHEAD SPEAKERS

TOP SELLER 2882876

XP 1000 '18-24, CREW XP 1000 '19-24, CREW 1000 '20-24,
1000 '20-24, XP KINETIC '23-24, DIESEL '20-24

+

OR

C. 25.4 CM MAXBOOST SUBWOOFER

2884233

XP 1000 '18-24, CREW XP 1000 '19-24, XP KINETIC '23-24,
DIESEL '20-24
WITH 900 WATT STATOR
NOT COMPATIBLE WITH UNDER SEAT DRY STORAGE
(2882910) INSTALLED

OPTION 2 DASH AUDIO

A. AUDIO DASH SPEAKERS

TOP SELLER 2883956

XP 1000 '19-24, CREW XP 1000 '19-24,
CREW 1000 '20-24, 1000 '20-24,
XP KINETIC '23-24, DIESEL '20-24

+

B. REAR OVERHEAD SPEAKERS

TOP SELLER 2882876

XP 1000 '18-24, CREW XP 1000 '19-24, CREW 1000 '20-24,
1000 '20-24, XP KINETIC '23-24, DIESEL '20-24

+

C. 25.4 CM MAXBOOST SUBWOOFER

2884233

XP 1000 '18-24, CREW XP 1000 '19-24, XP KINETIC '23-24,
DIESEL '20-24
RANGER MODELS WITH RIDE COMMAND PACKAGE REQUIRE
ADAPTER HARNESS (2883232), SOLD SEPARATELY
RANGER MODELS WITHOUT RIDE COMMAND USE
MAX BOOST 10" 250 WATT SUBWOOFER (2882890), SOLD SEPARATELY
NOT COMPATIBLE WITH UNDER SEAT DRY STORAGE
(2882910) INSTALLED

AUDIO DASH SPEAKERS INCLUDE BUILT-IN FOUR CHANNEL AMPLIFIER (40-WATTS) AND TWO OFF-ROAD GRADE 13.3 CM SPEAKERS

DOWNLOAD THE RIDE COMMAND MOBILE APP



1 CHOOSE A HEAD UNIT Control all aspects of your sound system. Choose what to listen to and how loud.



DASH STEREO

USE AS IS OR ADD ADDITIONAL SPEAKERS



VISOR STEREO

COMES WITH OVERHEAD VISOR SPEAKERS (AT RIGHT)
USE AS IS OR ADD ADDITIONAL SPEAKERS

160 WATT, WATERPROOF AM/FM BLUETOOTH AUDIO SYSTEM TOP SELLER **P**

- All-in-one solution for giving your vehicle a performance-ready sound system
- USB input, Bluetooth 4.0 compatible, Apple Control, AM/FM tuner*
- Built-in four channel amplifier (40-watts x 4)
- Two off-road grade 13.3 cm speakers with titanium dome tweeters and polypropylene cones

» 2882750

XP 1000 '18-24, CREW XP 1000 '19-24, CREW 1000 '20-24, 1000 '20-24, XP KINETIC '23-24, DIESEL '20-24

300 WATT AM/FM, BLUETOOTH AUDIO VISOR WITH FOUR 16.5 CM WATERPROOF SPEAKERS **P**

- One-step solution for off-road audio
- USB input, Bluetooth 4.0 compatible, Apple Control, AM/FM tuner*
- 300-Watt four channel amplifier (75 watts x 4)
- Four 16.5 cm coaxial speakers with titanium dome tweeters and polypropylene cones
- Audio outputs to drive additional speakers
- Four Accessory knocks outs

» 2882888

XP 1000 '18-24, CREW XP 1000 '19-24, CREW 1000 '20-24, 1000 '20-24, XP KINETIC '23-24, DIESEL '20-24
NOT COMPATIBLE WITH 7" DISPLAY POWERED BY RIDE COMMAND

2 ADD SPEAKERS - MIX AND MATCH



STANDARD WITH VISOR STEREO

300 WATT OVERHEAD AUDIO VISOR SPEAKERS

- Built-in 300-Watt amplifier (75-watt x 4 channels)
- Four 16.5 cm speakers located in the overhead
- Waterproof system for reliable power and sound quality

» 2882891†

XP 1000 '18-24, CREW XP 1000 '19-24, CREW 1000 '20-24, 1000 '20-24, XP KINETIC '23-24, DIESEL '20-24



REAR OVERHEAD SPEAKERS TOP SELLER

- Two 16.5 cm rear roof mounted speakers with titanium dome tweeters and polypropylene cones
- Easy install
- Waterproof system for reliable power and sound quality

» 2882876

XP 1000 '18-24, CREW XP 1000 '19-24, CREW 1000 '20-24, 1000 '20-24, XP KINETIC '23-24, DIESEL '20-24



MAX BOOST 25.4 CM 250 WATT SUBWOOFER XP 1000 ONLY

- Built-in 250-watt amplifier powering 25.4 cm waterproof subwoofer
- Fits RANGER XP 1000 with flip-up passenger seat

» 2882890

XP 1000 '18-24, CREW XP 1000 '19-24, XP KINETIC '23-24, DIESEL '20-24
NOT COMPATIBLE WITH 7" DISPLAY POWERED BY RIDE COMMAND
NOT COMPATIBLE WITH UNDER SEAT DRY STORAGE (2882910) INSTALLED

3 MAKE IT WORK

REQUIRED WITH VISOR STEREO SPEAKERS & HEAD UNIT

POLARIS PULSE ROOF 6

- Required with Visor Stereo (2882888)
- Required to add Visor Speakers (2882891†)

» 2882904

XP 1000 '18-24, CREW XP 1000 '19-24, CREW 1000 '20-24, 1000 '20-24, XP KINETIC '23-24, DIESEL '20-24

CREW MODELS

CREW EXTENSION

- Required for all Crew models where Polaris PULSE Roof 6 (2882904) is required

» 2883231

CREW XP 1000 '19-24, CREW 1000 '20-24

* The FM Frequency range is from 88 to 108 and only on the odds (i.e. 88.1, 88.3, etc.). † Not available in Europe.

CAB RIMS & ROOFS

WINDSHIELDS & REAR PANELS

CAB COMFORT & CONVENIENCE

WINCHES

PROTECTION & AUDIO

STORAGE

XP KINETIC

MAINTENANCE PARTS & FLUIDS

RANGER 1000 / XP 1000 / XP KINETIC / DIESEL

STORAGE



BRING IT ALL. BRING IT ON:

From opposite sides of the globe, some of the most capable machines in the off-road world meet a trusted outdoor adventure brand to deliver industry-exclusive, purpose-built roof racks, bed racks and attachments that help RANGER riders get the job done.

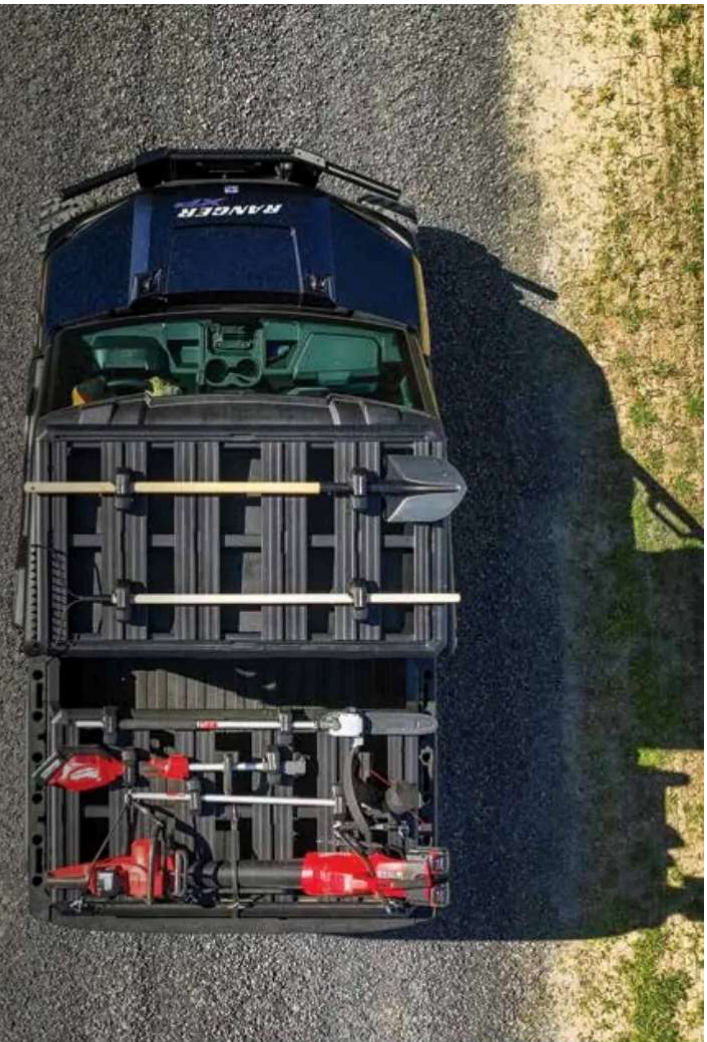

PICK YOUR RACK

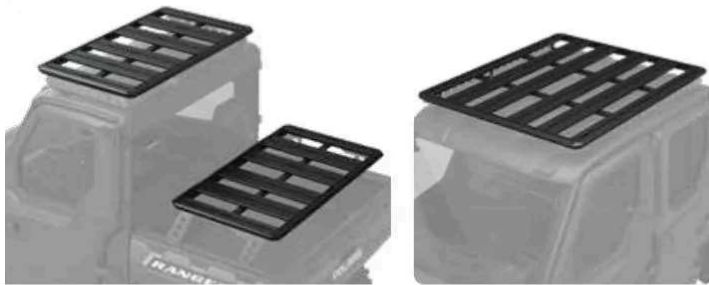

REAR BED RACK / ROOF RACK, SMALL

- Install either in the bed or on the roof of the vehicle (mounts sold separately)
- A durable backbone provides a secure vehicle attachment
- An innovative attachment system allows for easy accessory install
- 34 kg weight capacity per rack

» 2889236

XP 1000 '18-25, 1000 '20-25, XP KINETIC '23-24, DIESEL '20-25

ROOF RACK, LARGE

- Install on the roof of the vehicle (mount sold separately)
- A durable backbone provides a secure vehicle attachment
- An innovative attachment system allows for easy accessory install
- 68kg weight capacity

» 2889237

CREW XP 1000 '19-25, CREW 1000 '20-25

PICK YOUR MOUNT



REAR BED RACK MOUNT

» 2889235

XP 1000 '18-25, 1000 '20-25, CREW XP 1000 '19-25, CREW 1000 '20-25, XP KINETIC '23-24, DIESEL '20-25



ROOF RACK MOUNT

» 3-SEAT • 2889233

XP 1000 '18-25, 1000 '20-25, XP KINETIC '23-24, DIESEL '20-25

» CREW • 2889234

CREW XP 1000 '18-25, CREW 1000 '20-25



MAXIMIZE YOUR RIDE



BUILD THE ULTIMATE UTILITY VEHICLE



BUILT FOR THE LONG HAUL

1000 / XP 1000 / XP KINETIC / DIESEL

CAB RIMS & ROOFS

WINDSHIELDS & REAR PANELS

CAB COMFORT & CONVENIENCE

WINCHES

PROTECTION & AUDIO

STORAGE

XP KINETIC

MAINTENANCE PARTS & FLUIDS

ACCESSORIZE IT

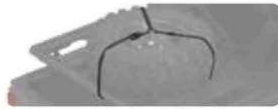

SPARE TIRE HOLDER

- Transport a spare tire outside the vehicle
- Easily mounts to the Rhino-Rack Rear Bed Rack (2889590), sold separately

» 2889529

XP 1000 '18-25, CREW XP 1000 '19-25, CREW 1000 '20-25, 1000 '20-25, XP KINETIC '23-24, DIESEL '20-25



J-STYLE KAYAK HOLDER

- Transport a kayak or canoe on the roof of your vehicle

» 2889883

XP 1000 '18-25, CREW XP 1000 '19-25, CREW 1000 '20-25, 1000 '20-25, XP KINETIC '23-24, DIESEL '20-25
REQUIRES ACCESSORY BARS (2889884), SOLD SEPARATELY

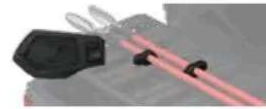

MULTI-PURPOSE TOOL HOLDER

- Carry and protect tools, paddles and more
- Ratchet-locking mechanism for quick release and rubber inserts that secure gear into place

» 2889528

XP 1000 '18-25, CREW XP 1000 '19-25, CREW 1000 '20-25, 1000 '20-25, XP KINETIC '23-24, DIESEL '20-25



FISHING ROD HOLDER

- Convenient, locking carrier can transport five fishing rods safely and securely on a roof rack
- Doubles as a ski/snowboard carrier

» 2889729

XP 1000 '18-25, CREW XP 1000 '19-25, CREW 1000 '20-25, 1000 '20-25, XP KINETIC '23-24, DIESEL '20-25



HIGH-LIFTING JACK MOUNT

- Simple, quick install with durable brackets
- Rugged, non-corrosive powder-coated steel stands up to the harshest conditions

» 2889533

XP 1000 '18-25, CREW XP 1000 '19-25, CREW 1000 '20-25, 1000 '20-25, XP KINETIC '23-24, DIESEL '20-25



TRACTION BOARD MOUNTS

- Strong, durable and easy to attach
- Traction boards sold separately

» 2889530

XP 1000 '18-25, CREW XP 1000 '19-25, CREW 1000 '20-25, 1000 '20-25, XP KINETIC '23-24, DIESEL '20-25

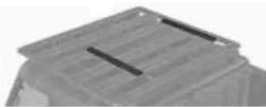

ACCESSORY BARS

- Offers horizontal fitment to allow other accessories to be attached to the Rhino-Rack® platforms

» 2889884

XP 1000 '18-25, CREW XP 1000 '19-25, CREW 1000 '20-25, 1000 '20-25, XP KINETIC '23-24, DIESEL '20-25



EYELET TIE-DOWNS

- Attach in multiple locations on the platform for additional tie-down points
- Anti-corrosive, galvanized steel for heavy duty strength
- Includes one set with hardware (straps not included)

» 2889527

XP 1000 '18-25, CREW XP 1000 '19-25, CREW 1000 '20-25, 1000 '20-25, XP KINETIC '23-24, DIESEL '20-25



GUN MOUNTING BRACKET

- Mount Kolpin Stronghold Gun Boots to Rhino-Rack systems when paired with Auto-Latch Mount (2889931), sold separately

» 2889327

XP 1000 '18-25, CREW XP 1000 '19-25, CREW 1000 '20-25, 1000 '20-25, XP KINETIC '23-24, DIESEL '20-25



CARGO CORNER BRACKETS

- Mount a NorthStar cooler or toolbox to the platform and save space inside the vehicle (straps not included)
- A unique, anti-rotation nut offers maximum security

» 2889531

XP 1000 '18-25, CREW XP 1000 '19-25, CREW 1000 '20-25, 1000 '20-25, XP KINETIC '23-24, DIESEL '20-25



200 L LUGGAGE BAG

- Carry bulky, lightweight gear in this tear- and weather-resistant canvas bag

» 2889881

XP 1000 '18-25, CREW XP 1000 '19-25, CREW 1000 '20-25, 1000 '20-25, XP KINETIC '23-24, DIESEL '20-25



FLAG BRACKET

- Securely mount flags or whips to Rhino-Rack® platform
- Adjustable bracket with 180-degree folding design
- Includes installation hardware

» 2891228

XP 1000 '18-25, CREW XP 1000 '19-25, CREW 1000 '20-25, 1000 '20-25, XP KINETIC '23-24, DIESEL '20-25



LIGHT BAR MOUNT

» 2891354

XP 1000 '18-25, CREW XP 1000 '19-25, CREW 1000 '20-25, 1000 '20-25, XP KINETIC '23-24, DIESEL '20-25



CUBE LIGHT MOUNT

» 2891355

XP 1000 '18-25, CREW XP 1000 '19-25, CREW 1000 '20-25, 1000 '20-25, XP KINETIC '23-24, DIESEL '20-25

RANGER 1000 / XP 1000 / XP KINETIC / DIESEL

STORAGE



Exclusive to Polaris, Lock & Ride accessories let you quickly change from one task to another with hundreds of options.

With the flip of a lever, Lock & Ride plungers use outward pressure to expand for secure fit.



300 LB. REAR CARGO BOX WINCH

- 300 lb. pull force winch that mounts to rear headache rack
 - Allows for easy loading of big game or other large and heavy items in the bed
- » 2889705

XP 1000 '18-25, CREW XP 1000 '18-25, CREW 1000 '20-25, 1000 '20-25, XP KINETIC '23-24, DIESEL '20-25
REQUIRES LOCK & RIDE HEADACHE RACK (2890233). SOLD SEPARATELY



FRONT BRUSHGUARD STORAGE RACK

- Allows extra storage space in front of your vehicle
 - Accommodates a Polaris Northstar 28 L Cooler or similar sized items
 - Attaches and removes easily
 - Mounts to existing plow mounting points
- » 2883971

XP 1000 '18-25, CREW XP 1000 '18-25, CREW 1000 '20-25, 1000 '20-25, XP KINETIC '23-24, DIESEL '20-25
NOT COMPATIBLE WITH BIG GAME OR WATERFOWL MODELS (NO FACTORY PLOW MOUNTS)



HEADACHE RACK TOP SELLER

- Lightweight and heavy-duty rack protects the cab of your RANGER and lets you haul even more
- » 2890233

XP 1000 '17-25, CREW XP 1000 '18-25, CREW 1000 '20-25, 1000 '20-25, XP KINETIC '23-24, DIESEL '20-25



CARGOMAX SYSTEM TOP SELLER

- Comes standard with a support bar that ties the two sides together for a sturdy cargo hold
 - Designed to attach to the Lock & Ride Tip-Down Headache Rack for additional support and three-sided containment
 - Adjustable utility hooks provide more options for hanging tools, cords or gear
- » 2882177

XP 1000 '17-25, CREW XP 1000 '18-25, CREW 1000 '20-25, 1000 '20-25, XP KINETIC '23-24, DIESEL '20-25



FRONT HOOD STORAGE RACK TOP SELLER

- Front curve helps keep cargo in place when traveling
 - Provides additional protection
 - Fully integrated pivots to gain under-hood access
 - Requires Accessory Bumper Hardware (2207941), sold separately, when used with 7" Display powered by RIDE COMMAND
- » 2890583

XP 1000 '25, CREW XP 1000 '25, DIESEL '25
DOES NOT FIT WITH UPPER FRONT BRUSHGUARD (2890232)
REQUIRES ACCESSORY BUMPER HARDWARE (2207941), SOLD SEPARATELY, TO WORK WITH FRONT CAMERA

» 2882690

XP 1000 '18-24, CREW XP 1000 '19-24, CREW 1000 '20-25, 1000 '20-25, XP KINETIC '23-24
DOES NOT FIT WITH BUMPER (2882531)



REAR SEAT STORAGE - CREW

- Attaches easily to the rear of the front seat in your crew vehicle
 - Provides storage pockets for a variety of items, ensuring they're always within reach
- » 2889268

CREW XP 1000 '18-25, CREW 1000 '20-25, DIESEL '20-25



BED EXTENDER/DIVIDER TOP SELLER

- Extend or divide the cargo box
 - Installs in any location in the box
 - Multiple tie-down points available to secure cargo
- » 2882752



XP 1000 '18-25, CREW XP 1000 '19-25, CREW 1000 '20-25, 1000 '20-25, XP KINETIC '23-24, DIESEL '20-25
DOES NOT FIT WITH CARGOMAX SYSTEM (2882177)



SPARE TIRE CARRIER

- Includes one spare tire carrier
 - Quick installation
 - Tire carrier mounts to the rear cab to keep cargo bed free and easily accessible
 - Maximum tire size supported is 30"
- » 2889193

XP 1000 '18-25, CREW XP 1000 '19-25, CREW 1000 '20-25, 1000 '20-25, XP KINETIC '23-24, DIESEL '20-25



1000 / XP 1000 / XP KINETIC / DIESEL

75+ COMBINATIONS TO MAKE IT YOUR OWN

With a full line of Lock & Ride accessories, you can haul more and do more. Use the chart below to see what combinations work together.

POLARIS RANGER STORAGE MATRIX 1000 / XP 1000 / XP KINETIC 570 FULL-SIZE	Headache Rack	CargoMax System	Bed Extender/Divider	Storage Box	Tool Rack	Chainsaw Mount	60 Gallon Boomless Utility Sprayer	300 lb. Rear Cargo Box Winch	Front Brushguard Storage Rack	Cargo Bed Mat	RHINO-RACK Roof Rack - 3-Seat	RHINO-RACK Bed Rack - 3-Seat & Crew	RHINO-RACK Roof Rack - Crew
	2890233	2882177	2882752	2883279	2881533	2879354	2879799	2889705	2883971	2882751	2889236	2889236	2889237
Headache Rack	2890233	✓	✓	✓	✓	✓	✓	✓	✓	✓	✓	✓	✓
CargoMax System	2882177	✓	✓	✓ ²	✓	✓	✓	✓	✓	✓	✓	✓	✓
Bed Extender/Divider	2882752	✓	✓	✓	✓	✓	✓	✓	✓	✓	✓	✓	✓
Storage Box	2883279	✓	✓ ¹	✓	✓	✓	✓	✓	✓	✓	✓	✓	✓
Tool Rack	2881533	✓	✓	✓	✓	✓	✓	✓	✓	✓	✓	✓	✓
Chainsaw Mount	2879354	✓	✓	✓	✓	✓	✓	✓	✓	✓	✓	✓	✓
60 Gallon Boomless Utility Sprayer	2879799	✓	✓	✓	✓	✓	✓	✓	✓	✓	✓	✓	✓
300 lb. Rear Cargo Box Winch	2889705	✓	✓	✓	✓	✓	✓	✓	✓	✓	✓	✓	✓
Front Brushguard Storage Rack	2883971	✓	✓	✓	✓	✓	✓	✓	✓	✓	✓	✓	✓
Cargo Bed Mat	2882751	✓	✓	✓	✓	✓	✓	✓	✓	✓	✓	✓	✓
RHINO-RACK Roof Rack - 3-Seat	2889236	✓	✓	✓	✓	✓	✓	✓	✓	✓	✓	✓	✓
RHINO-RACK Bed Rack - 3-Seat & Crew	2889236	✓	✓	✓	✓	✓	✓	✓	✓	✓	✓	✓	✓
RHINO-RACK Roof Rack - Crew	2889237	✓	✓	✓	✓	✓	✓	✓	✓	✓	✓	✓	✓

¹ Storage box at front of cargo box if not used with Tip-down Headache Rack ² Storage box at front of cargo box

CAB RIMS & ROOFS
WINDSHIELDS & REAR PANELS
CAB COMFORT & CONVENIENCE
WINCHES
PROTECTION & AUDIO
STORAGE
XP KINETIC
MAINTENANCE PARTS & FLUIDS

QUICKSTRAP

- The quickest and most secure way to mount Polaris accessories
- Sold as a pair

» 2882187

ALL COOLERS, RANGER CARGO BOXES



D-RINGS

TOP SELLER

- The most versatile Lock & Ride accessory - add as many as you need to secure your cargo with bungee cords or straps

» 2881545

ALL RANGER CARGO BOXES



3.8 CM X 4.6 M 2495 KG RATCHET STRAP

- Heavy-duty webbing
- 2,495 kg maximum load / 831 kg working load
- 2 Pack

» 2884031

5.1 CM X 6.1 M 4536 KG RATCHET STRAP

- Heavy-duty webbing
- 4,536 kg maximum load / 1,497 kg working load
- Floating D-Rings and Double J-Hooks

» 2884032

RANGER 1000 / XP 1000 / XP KINETIC / DIESEL

MISC ACCESSORIES

BED ESSENTIALS



OFF-ROAD TOOL KIT BY CRUZTOOLS®

» 2890429
 XP 1000 '17-25, CREW XP 1000 '18-25,
 CREW 1000 '20-25, 1000 '20-25,
 XP KINETIC '23-24, DIESEL '20-25



FIRE EXTINGUISHER HOLDER

- Only holds a 8.3 cm diameter extinguisher
- Quick release strap allows for easy use

» 2882158
 XP 1000 '17-25, CREW XP 1000 '18-25,
 CREW 1000 '20-25, 1000 '20-25,
 XP KINETIC '23-24, DIESEL '20-25



CARGO BED MAT

- Non-slip surface to better secure loads and keep cargo bed clean

» 2882751
 XP 1000 '18-25, CREW XP 1000 '18-25,
 CREW 1000 '20-25, 1000 '20-25,
 XP KINETIC '23-24, DIESEL '20-25



ELECTRONIC CARGO BOX LIFT

» 2884141
 XP 1000 '18-25, CREW XP 1000 '18-25,
 CREW 1000 '20-25, 1000 '20-25,
 XP KINETIC '23-24, DIESEL '20-25

TOW & HAUL



TRAILER BALLS

» 5 cm WITH 1.9 cm SHANK
 2877603
 » 4.8 cm WITH 1.9 cm SHANK
 2877602



5 CM BALL MOUNT

» 5 cm RECEIVER
 2875320



3:1 HITCHES

» 5 cm x 5 cm RECEIVER
 2830522
 » 3 cm x 3 cm RECEIVER
 2830523
 » 4.8 cm REPLACEMENT BALL
 2830524



FRONT RECEIVER HITCH

» 5 cm WITH 1.9 cm SHANK
 2884692



1000 / XP 1000 / XP KINETIC / DIESEL

TASK-SPECIFIC TOOLS

TOOL RACK

- Attach on the inside or outside of the cargo bed
- » 2881533
- XP 1000 '17-25, CREW XP 1000 '18-25, CREW 1000 '20-25, 1000 '20-25, XP KINETIC '23-24, DIESEL '20-25

TRASH CAN HAULER

- Receiver mounted trash can hauler that allows slow speed towing of 2 trash cans
- Ideal for hauling cans down long driveways
- » 2889876
- SP 570 '22-25, CREW SP 570 '22-25, DIESEL '20-25



ORGANIZE & PROTECT

STORAGE BOX

- Enough room to store all the tools you need to get the job done
- Internal organizational dividers keep gear from rolling around
- Easily detaches from vehicle
- » 2883279
- XP 1000 '17-25, CREW XP 1000 '18-25, CREW 1000 '20-25, 1000 '20-25, XP KINETIC '23-24, DIESEL '20-25



CAB RIMS & ROOFS

WINDSHIELDS & REAR PANELS

CAB COMFORT & CONVENIENCE

WINCHES

PROTECTION & AUDIO

STORAGE

XP KINETIC

MAINTENANCE PARTS & FLUIDS

DO MORE:



COOLERS P. 72



HUNT P. 70



COLD WEATHER P. 58



LIGHTING P. 62

RANGER 1000 / XP 1000 / XP KINETIC / DIESEL

RANGER XP KINETIC THE POWER TO DO MORE

DO MORE THAN EVER BEFORE with the full-size electric RANGER. Unmatched horsepower and instant torque means more power than ever before to precisely pull, haul more, and get more done. The industry's strongest drivetrain delivers lower maintenance costs and more uptime to get the job done. Plus, the quiet electric powertrain enables easy conversations while riding and stealthy trips to hunting spots.





FRONT CAMERA FOR RIDE COMMAND TECHNOLOGY

- Provides additional vantage point
- Front-mounted camera to help with plowing and other tasks

» 2889662
XP KINETIC '23-24



ACCESSORY BUMPER HARDWARE

- Required when using a front camera as well as an upper front bumper or hood rack

» 2889659
XP KINETIC '23-24



DUAL CHARGER HARNESS

- Required for installation of a 3kW On-Board Charger on XP Kinetic Premium trims

» 2890122
XP KINETIC '23-24



TRIPLE CHARGER HARNESS

- Required for installation of a 3kW On-Board Charger on XP Kinetic Ultimate trims

» 2890121
XP KINETIC '23-24



IN-CAB HEATER AND DEFROST KIT

- Instant heat, no more waiting for engine to warm up
- Easily control the climate inside your cab in any season
- Helps defrost windshields and keep you warm or cool
- Three different fan speeds
- Heat and fan dash-mounted controls
- Manual vents

» 2889449
XP KINETIC '23-24
REQUIRES HIGH VOLTAGE BUSBAR (2889667) AND ADHESIVE ACCESSORY KIT (2890070), EACH SOLD SEPARATELY



3kW ON-BOARD CHARGER

- Provides additional 3kW charge so you can save time and get more done with your RANGER
- Increases charge rate while decreasing charge time when connected to appropriate in home charger for more efficiency
- Maximum charge of 6kW on Premium trims and 9kW on Ultimate trims
- Upgraded Level 2 EVSE + 240V outlet required for optimal charging for Ultimate trim with 9kW upgrade
- Pair with Wallbox Pulsar Plus for optimal charging for Ultimate trim with 9kW upgrade

» 2889661
XP KINETIC '23-24
ULTIMATE TRIM: REQUIRES HIGH VOLTAGE BUSBAR (2889667), ADHESIVE ACCESSORY KIT (2890070) AND TRIPLE CHARGER HARNESS (2890121), EACH SOLD SEPARATELY
PREMIUM TRIM: REQUIRES HIGH VOLTAGE BUSBAR (2889667), ADHESIVE ACCESSORY KIT (2890070) AND DUAL CHARGER HARNESS (2890122), EACH SOLD SEPARATELY



HIGH VOLTAGE BUSBAR

- Required for adding heater or other high voltage accessories such as upgraded chargers

» 2889667
XP KINETIC '23-24
REQUIRES ADHESIVE ACCESSORY KIT (2890070), SOLD SEPARATELY



WALLBOX PULSAR MAX 11KW 3-PHASE EVSE

- For RANGER XP Kinetic Premium with additional 3kW charger and Ultimate trim standard and with additional 3kW charger
- It allows a faster charge for 6kW or 9kW chargers set-up compared with one-phase standard EVSE
- 3-phase (380V) power supply required

» 673V0001
XP KINETIC '23-24

1000 / XP 1000 / XP KINETIC / DIESEL

CAB KITS & ROOFS

WINDSHIELDS & REAR PANELS

CAB COMFORT & CONVENIENCE

WINCHES

PROTECTION & AUDIO

STORAGE

XP KINETIC

MAINTENANCE PARTS & FLUIDS

RANGER 1000 / XP 1000 / XP KINETIC / DIESEL

MAINTENANCE PARTS & FLUIDS



POLARIS ENGINEERED PARTS AND OIL have been validated and tested extensively, specifically for your vehicle. In order to maintain the peak performance of your Polaris vehicle only use official Polaris Engineered parts and oil.



We're taking the passion of our riders, workers, and outdoor enthusiasts to the next level with HD Parts. These Heavy Duty parts are engineered for riders who want greater durability and enhanced performance. HD Parts are designed and tested to handle greater wear and tear under all weather conditions.

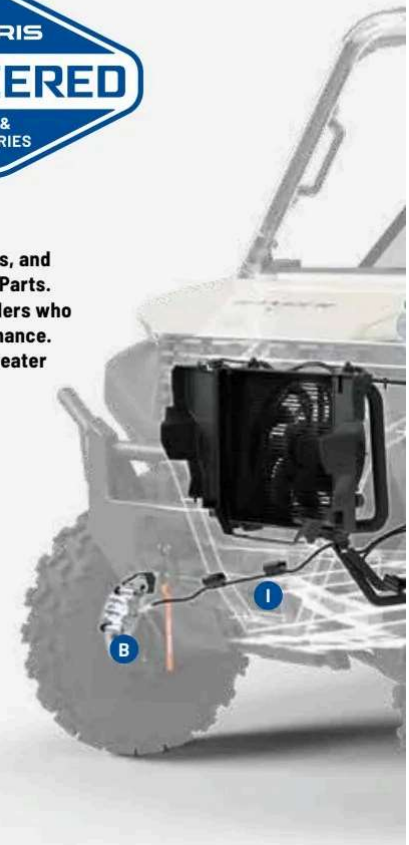

- A DRIVE BELT**
- » 1000 • 3211218
 - » XP 1000 / DIESEL • 3211186



- B BRAKE PADS**
- » FRONT • 2209279
 - » FRONT • **HD** • 2208933
 - » REAR • 2203318
DIESEL



- C OIL FILTER**
- » 2540086
1000/ XP 1000
 - » **HD** • 2522498
1000/ XP 1000
 - » 3070549
DIESEL
XP KINETIC DOES NOT HAVE AN OIL FILTER



- D BATTERY**
- » 4015591
1000/ XP 1000/ DIESEL
 - » 4014132
XP KINETIC
 - » **HD** • 4081855
XP 1000



- E AIR FILTER**
- » 7082265
1000/ XP 1000
 - » **HD** • 7083113
1000/ XP 1000
 - » 7082087
DIESEL



- F SPARK PLUGS**
- » 1000 • 3023571
 - » XP 1000 • 3022662

LOOKING FOR MORE SERVICE PARTS?

See P. 113 to learn how to find parts for your model.

MAINTENANCE SCHEDULE*

RANGER 1000 / XP 1000

BREAK-IN MAINTENANCE

FIRST 25 HRS | 500 MI / 800 KM

- ENGINE OIL & OIL FILTER CHANGE
- FRONT GEARCASE INSPECT FLUID
- BRAKE PADS INSPECT
REPLACE AS NEEDED
- BRAKE FLUID INSPECT
ADD FLUID AS NEEDED
- TRANSMISSION FLUID INSPECT
ADD FLUID AS NEEDED

12 MONTHS

200 HRS | 2,000 MI / 3,200 KM

- AIR FILTER REPLACE
- BATTERY TEST & CLEAN
REPLACE AS NEEDED
- BRAKE PADS INSPECT
REPLACE AS NEEDED
- DRIVE BELT INSPECT
REPLACE AS NEEDED
- ENGINE OIL & OIL FILTER CHANGE
- FRONT GEARCASE CHANGE FLUID
- GENERAL LUBRICATION ALL FITTINGS, PIVOTS, CABLES, ETC.
- SPARK PLUGS INSPECT
REPLACE AS NEEDED
- TRANSMISSION FLUID CHANGE FLUID

24 MONTHS

400 HRS | 4,000 MI / 6,400 KM

- AIR FILTER REPLACE
- BATTERY TEST & CLEAN
REPLACE AS NEEDED
- BRAKE PADS INSPECT
REPLACE AS NEEDED
- BRAKE FLUID CHANGE
- DRIVE BELT INSPECT
REPLACE AS NEEDED
- ENGINE OIL & OIL FILTER CHANGE
- FRONT GEARCASE CHANGE FLUID
- GENERAL LUBRICATION ALL FITTINGS, PIVOTS, CABLES, ETC.
- SPARK PLUGS INSPECT
REPLACE AS NEEDED
- TRANSMISSION FLUID CHANGE FLUID

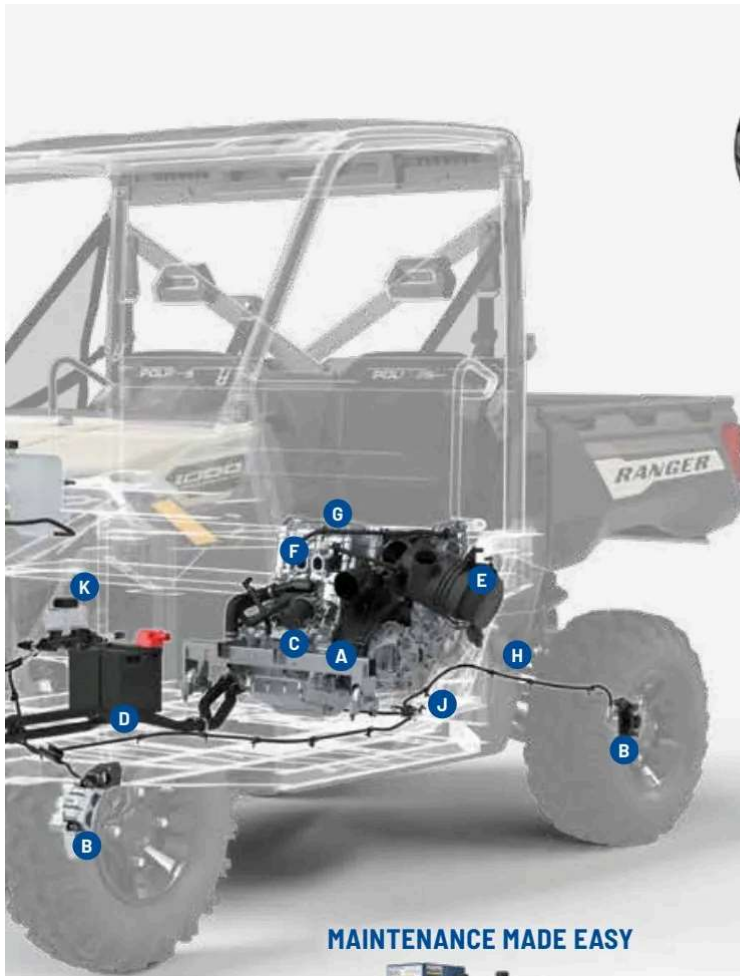

MAINTENANCE MADE EASY



OIL CHANGE KITS
 3 L Engine Oil, 1 Oil Filter (2540086)
 » PS-4 • 502543
 1000, XP 1000

G ENGINE OIL P. 84
 » PS-4 • 1L • 502484
 » PS-4 • 4 L • 502485
 » PS-4 EXTREME • 1L • 503220
 » PS-4 EXTREME • 4 L • 503221
 » DIESEL • 1L • 502573
 » DIESEL • 4L • 502574
 NOT COMPATIBLE WITH XP KINETIC

H ANGLE DRIVE FLUID
 For rear gearcase
 » 1L • 503320
 » 25 L • 503318
 » 202 L • 503317
 ONLY COMPATIBLE WITH XP KINETIC

I DEMAND DRIVE FLUID
 For front gearcase
 » 1L • 502563
 » 25 L • 502564
 » 200 L • 502565

J AGL
 For transmission
 » 1L • 502505
 » 25 L • 502507
 » 200 L • 502508

K DOT 4 BRAKE FLUID
 » 250 ML • 502526

ALL-SEASON GREASE TUBE
 » 400 G • 502538

Claims made based off testing and performance of Polaris HD Parts against standard OEM parts made by Polaris and competitor brands under normal use. For more information regarding Polaris HD parts including vehicle compatibility, installation and maintenance, please contact your authorized Polaris ORV dealer.

RANGER XP KINETIC

36 MONTHS
 600 HRS | 6,000 MI / 9,700 KM

AIR FILTER REPLACE	FRONT GEARCASE CHANGE FLUID
BATTERY TEST & CLEAN REPLACE AS NEEDED	GENERAL LUBRICATION ALL FITTINGS, PIVOTS, CABLES, ETC.
BRAKE PADS INSPECT REPLACE AS NEEDED	SPARK PLUGS INSPECT REPLACE AS NEEDED
DRIVE BELT INSPECT REPLACE AS NEEDED	TRANSMISSION FLUID CHANGE FLUID
ENGINE OIL & OIL FILTER CHANGE	

EVERY 1,000 MILES
 1,600 KM

BRAKE PADS INSPECT REPLACE AS NEEDED
BATTERY TEST & CLEAN REPLACE AS NEEDED
FRONT GEARCASE CHANGE FLUID
GENERAL LUBRICATION ALL FITTINGS, PIVOTS, CABLES, ETC.
TRANSMISSION FLUID CHANGE FLUID

EVERY 2,000 MILES
 3,200 KM

FOR A COMPLETE MAINTENANCE SCHEDULE, CHECK YOUR OWNER'S MANUAL

BRAKE FLUID CHANGE
BRAKE PADS INSPECT REPLACE AS NEEDED
BATTERY TEST & CLEAN REPLACE AS NEEDED
FRONT GEARCASE CHANGE FLUID
GENERAL LUBRICATION ALL FITTINGS, PIVOTS, CABLES, ETC.
TRANSMISSION FLUID CHANGE

*This is a sample maintenance schedule. Please reference and use your owners manual for full maintenance and vehicle care.

RANGER SP 570

CUSTOMIZE YOUR RANGER

MAXIMIZE YOUR EXPERIENCE

COMPRISED OF TOP SELLING ACCESSORIES FOR YOUR MODEL,

The Owners Essentials Package is a great place to start accessorizing your RANGER.



OWNER ESSENTIALS PACKAGE

2885077 Sport Roof - Poly** P. 44

2885080 Full Glass Windshield - Clear** P. 46

2879965  Rear Panel - Glass** P. 47

2890288 Sun Visor P. 48

2889187 Convex Weatherproof Rearview Mirror** P. 48

2885095 Polaris HD 1,588 kg Winch** P. 49

3211218 Drive Belt** P. 52

**Standard on NorthStar Editions. Additional recommendations for NorthStar models: Rock Guard with Step (2889180) & Rear Brushguard(2885087)

SHOP BY USE

PACKAGES MADE FOR THE WAY YOU RANGER

ADD ON TO THE OWNER ESSENTIALS PACKAGE TO CUSTOMIZE FOR HOW YOU USE YOUR RANGER.

FARM PACKAGE



2885077 Sport Roof - Poly P. 44

2889187 Convex Weatherproof Rearview Mirror P. 48

2885095 Polaris HD 1,588 kg Winch P. 49

2889538 Headache Rack P. 50

2889189 Cargo Bed Mat P. 50



HUNT PACKAGE

- 2889666 Rear Headache Rack - Winch Ready P. 48
- 2889199  Storage Box P. 50
- 2885088  Front Hood Storage Rack P. 50
- 2890134 300 Lb. Rear Cargo Box Winch P. 50
- 2889181 Rock Guard with Step - Crew* P. 51

- 2884299 RIGID® SR-Series 81 cm Combo LED Light Bar P. 63
- 2890053 Light Bar Mount P. 63
- 2889161 Polaris PULSE Wiring Harness - 1 LED Light Bar P. 68
- 2882036 Kolpin Stronghold Gun Boot XL P. 70
- 2884106  Kolpin Stronghold Auto-Latch Boot Mount P. 70

*2-Seat uses 2889180



LANDOWNER PACKAGE

- 2889189 Cargo Bed Mat P. 50
- 2889199  Storage Box P. 51

- 2881533  Tool Rack P. 50
- 2889791 Pro Armor 84 cm Single-Row Combo LED Light Bar P. 63



TRAIL PACKAGE

- 2880551 Rear A-Arm Guards P. 51
- 2889183  Bed Extender/Divider P. 50
- 2889199  Storage Box P. 50
- 2889181 Rock Guard with Step - Crew* P. 51

- 2889790 Pro Armor 78.7 cm Dual-Row Combo LED Light Bar P. 63
- 2890053 Light Bar Mount P. 63
- 2889161 Polaris PULSE Wiring Harness - 1 LED Light Bar P. 68

*2-Seat uses 2889180

RANGER SP 570

ROOFS

WINDSHIELDS
& REAR PANELS

CAB COMFORT
& CONVENIENCE

AUDIO
& WINCHES

STORAGE &
PROTECTION

MAINTENANCE
PARTS & FLUIDS

RANGER SP 570

ROOFS

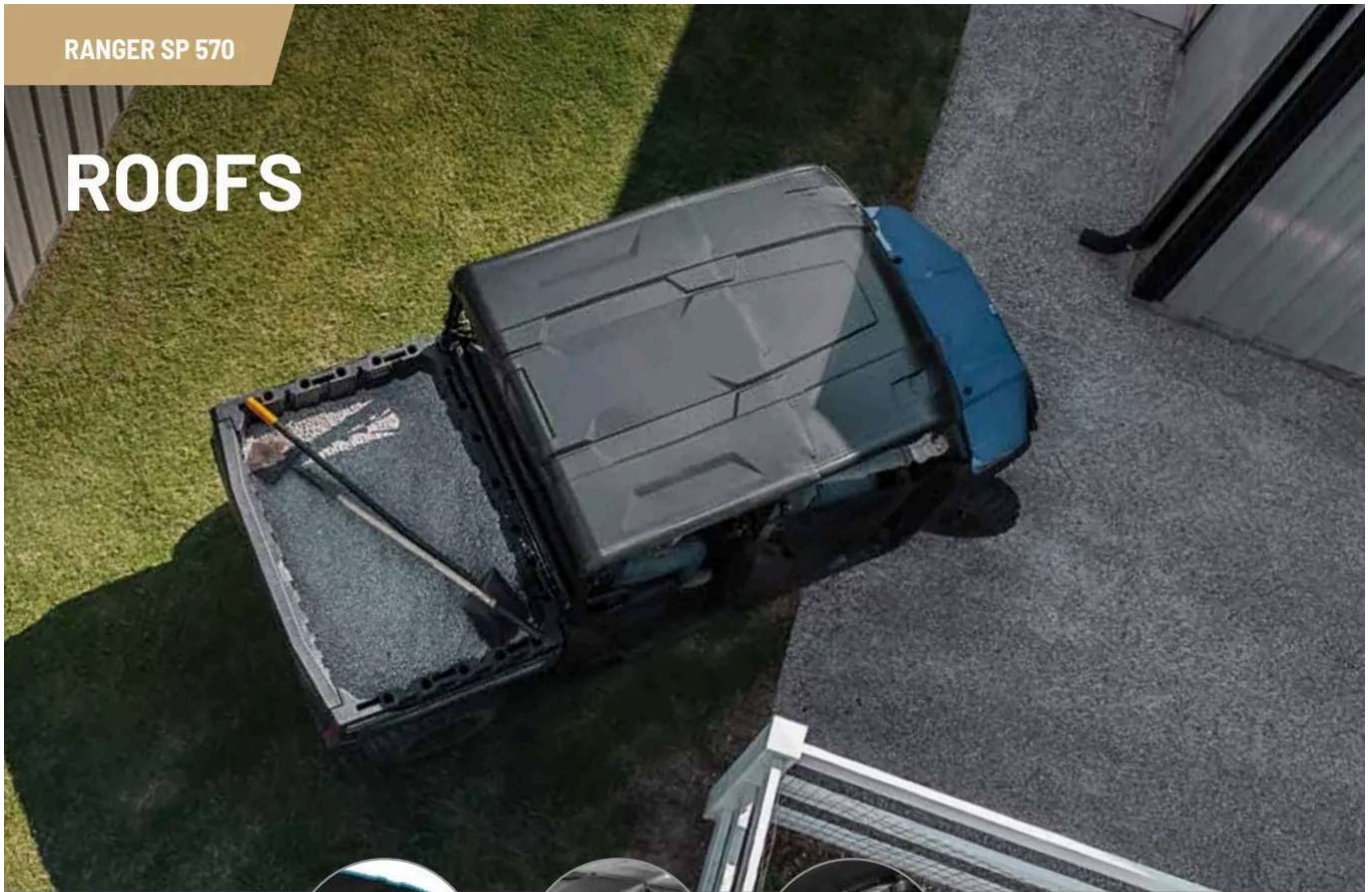

POLY FEATURES

- Water run-off
- Polaris PULSE plug and play
- Liner ready
- Lightweight



SEALED COVERAGE



REDUCE STANDING WATER



LR LOCK & RIDE
EASY AND FAST INSTALLATION

POLARIS ENGINEERED ADVANTAGES

POLY

Lightweight, durable and impact-resistant. A poly roof can take the abuse of a tight trail and still protect.



PRO SHIELD
CAB SYSTEMS

SPORT ROOF - POLY TOP SELLER

- Offers reliable protection from the sun and rain
- Lightweight, durable polyethylene construction
- Simple one-time installation

- › **2-SEAT • BLACK • 2885077**
SP 570 '22-25
- › **CREW • BLACK • 2885078**
CREW SP 570 '22-25

PREMIUM ROOF LINER

- Cut in-cab noise by 60% at idle and by 40% at 20 mph
- One-piece liner attaches quickly and securely using push darts
- Adds premium comfort and quieter cab ride
- › **2-SEAT (SHOWN) • 2885093**
SP 570 '22-25
- › **CREW • 2885094**
CREW SP 570 '22-25



RANGER SP 570

HOOPS

WINDSHIELDS
& REAR PANELS

CAB COMFORT
& CONVENIENCE

AUDIO
& WINCHES

STORAGE &
PROTECTION

MAINTENANCE
PARTS & FLUIDS

RANGER SP 570

WINDSHIELDS & REAR PANELS

GLASS vs HARD COAT POLY

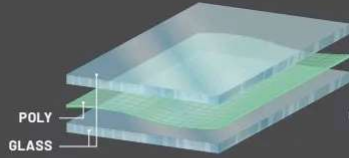

Superior optical clarity (automotive level)
 Scratch-resistant
 Curved to fit, seals tight
 Cold weather / heavy duty
 Wiper ready

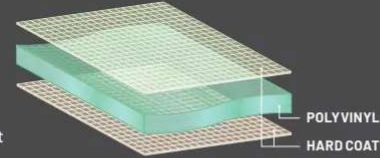

Lightweight, flexible, easy to store/remove
 Impact-resistant
 Tight seal keeps out rain and dust
 30x more scratch resistant

WINDSHIELDS

OPEN



PRO SHIELD
 CAB SYSTEMS

FULL TIP-OUT WINDSHIELD - GLASS TOP SELLER

- Tip-out design offers three positions: open, closed and vented
- Gas shocks assist in easy opening and closing
- 360° gasket for reliable protection and comfort
- Scratch-resistant automotive-style curved glass
- Interior sound dampening and optimized visibility

» 2885079

SP 570 '22-25, CREW SP 570 '22-25



WIPER AVAILABLE
 P. 48



PRO SHIELD
 CAB SYSTEMS

FULL GLASS WINDSHIELD - CLEAR TOP SELLER

- Scratch-resistant, curved laminate safety glass
- Protects against wind, rain and other hazardous debris
- UV-blocking interlayer and 360° gasket seal

» 2885080

SP 570 '22-25, CREW SP 570 '22-25



VENTED WINDSHIELD - HARD COAT POLY

- Frameless design for maximum visibility
- Added vents for airflow on a hot day or defrosting on a cold day

» 2883342

SP 570 '22-25, CREW SP 570 '22-25



PRO SHIELD
 CAB SYSTEMS

FULL WINDSHIELD - HARD COAT POLY TOP SELLER

- Durable, optical-grade, 0.6 cm-thick polycarbonate offers outstanding rider protection and visibility
- Windshield has minimal perimeter framework for full visibility

» 2883319

SP 570 '22-25, CREW SP 570 '22-25



PRO SHIELD
 CAB SYSTEMS

FULL WINDSHIELD - POLY TOP SELLER

- Durable, optical-grade, 0.6 cm-thick polycarbonate offers outstanding rider protection and visibility
- Windshield has minimal perimeter framework for full visibility

» 2883318

SP 570 '22-25, CREW SP 570 '22-25



HALF WINDSHIELD - POLY

- Strong, durable polycarbonate half windshield delivers a combination of protection and airflow into the cab
- Half windshield offers protection from rain, sleet, spray, and off-road hazards

» 2883320

SP 570 '22-25, CREW SP 570 '22-25

POLARIS ENGINEERED ADVANTAGES



LOCK & RIDE
REVOLUTIONARY
INSTALLATION



AIRTIGHT
GASKET SEAL

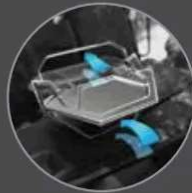

VENTING
OPTIONS



MULTI-FUNCTION
FEATURES



ROOFS

WINDSHIELDS
& REAR PANELS

CAB COMFORT
& CONVENIENCE

AUDIO
& WINCHES

STORAGE &
PROTECTION

MAINTENANCE
PARTS & FLUIDS

REAR PANELS



PRO SHIELD
CAB SYSTEMS

REAR PANEL - GLASS TOP SELLER

- Durable, tempered laminate glass provides a high level of scratch resistance
- » 2879965

SP 570 '22-25, CREW SP 570 '22-25



PRO SHIELD
CAB SYSTEMS

REAR PANEL - POLY

- Strong, 0.6 cm-thick polycarbonate provides outstanding impact and scratch resistance
- » 2879812

SP 570 '22-25, CREW SP 570 '22-25



REDUCE IN-CAB DUST SWIRL
BY ADDING A REAR PANEL

With a windshield and roof installed, turbulent air develops behind the cab. Add a rear panel to reduce dust intrusion from this swirl.

RANGER SP 570

CAB COMFORT & CONVENIENCE



HEATER KIT TOP SELLER

- Climate control for the cab of your off-road vehicle
- Total of four dash mounted vents with two positioned for defrosting the windshield and the other two for heating the cab
- Simple, dash-mounted controls
- Manually operated vents for airflow control

» **2885082**

SP 570 '22-25, CREW SP 570 '22-25
2022 SP 570 & HUNTER EDITION REQUIRE FRONT PULSE BAR AND HARNESSES 2889185



WINDSHIELD WIPER & WASHER KIT TOP SELLER

- Helps clear hazardous dirt, rain and debris from your windshield

» **2885083**

SP 570 '22-25, CREW SP 570 '22-25
2022 SP 570 & HUNTER EDITION REQUIRE FRONT PULSE BAR AND HARNESSES 2889185



CONVEX WEATHERPROOF REAR VIEW MIRROR

- Convex design for a broader view of traffic
- Durable, weatherproof construction
- Mount the bolts into your choice of pre-designated mounting locations
- Compatible with roof, windshield, and other accessories

» **2889187**

SP 570 '22-25, CREW SP 570 '22-25



SIDE VIEW MIRRORS

- » **DOOR MOUNTED** • 2889241
- » **ROPS-MOUNTED (SHOWN)** • 2889243
SP 570 '22-25, CREW SP 570 '22-25



12V CARGO BED POWER KIT WITH DASH SWITCH

- Maximize productivity with 12v Cargo Box Power Port to power your tools or accessories to get the job done

» **2889874**

SP 570 '22-25, CREW SP 570 '22-25



FLOOR MATS - FRONT

- Protects floors from dirt and wear
- Textured, non-slip surface

» **2889186**

SP 570 '22-25, CREW SP 570 '22-25



SUN VISOR TOP SELLER

- Injection molded visors for seamless fit to protection from the sun

» **2890288**

SP 570 '22-25, CREW SP 570 '22-25

DOME LIGHT

- LED Dome light provides optimal visibility in the cab
- Easy to install

» **2889159**

SP 570 '22-25, CREW SP 570 '22-25
2022 SP 570 & HUNTER EDITION REQUIRE FRONT PULSE BAR AND HARNESSES (2889185)

SP 570 SEAT COVERS - BLACK

- Strong, durable Carhartt® seat covers for both the seat bottom and backrest
- Designed to fit snug and stay wrinkle free, so it won't slip, slide, or bunch up
- Machine washable for easy cleaning

» **2889879-458**

SP 570 '22-25, CREW SP 570 '22-25
U.S. MODELS ONLY

CAB SEAL KIT

- Seal out dust from your UTV cab
- Reduces dust from getting on dash and seat

» **2889201**

SP 570 '22-25, CREW SP 570 '22-25
(INCLUDED WITH PREMIUM DOORS)
U.S. MODELS ONLY

ELECTRONIC POWER STEERING KIT

- Smoothest, most powerful electronic power steering available for your Polaris RANGER
- Variable assist for easier steering at lower speeds
- Greater responsiveness at higher speeds
- Front PULSE Bar required

» **2889464**

» **EPS HARNESS KIT** • 2890069

SP 570 '22-25, CREW SP 570 '22-25

FRONT PULSE BAR AND HARNESS

- This kit is needed to install any electrical accessories to a base vehicle

» **2-SEAT** • 2889185

SP 570 '22-25, CREW SP 570 '22-25

» **CREW** • 2889568

CREW SP 570 '22-25



AUDIO

POLARIS RIDE COMMAND

7" DISPLAY POWERED BY RIDE COMMAND

» 2884072

SP 570 '22-25
SPEAKERS NOT INCLUDED

MORE INFORMATION P. 64



JBL DASH AUDIO KIT

- System mounts into pre-designated locations in the vehicle dash
- Complete UTV audio solution gives your vehicle a performance-ready sound system
- Includes four off-road grade, water- and dust-proof speakers, and one head unit
- Head unit features AM/FM/WB tuner*, USB input and Bluetooth compatibility for wireless streaming

» 2885081

SP 570 '22-25

TO INSTALL JBL® DASH AUDIO KIT AND 7" DISPLAY POWERED BY RIDE COMMAND (2884072), 7" DISPLAY MOUNT KIT (2889163) IS REQUIRED, SOLD SEPARATELY.

RANGER SP 570

ROOFS

WINDSHIELDS & REAR PANELS

CAB COMFORT & CONVENIENCE

AUDIO & WINCHES

STORAGE & PROTECTION

MAINTENANCE PARTS & FLUIDS

WINCHES



FEATURES & BENEFITS	PRO HD SERIES	HD SERIES
---------------------	---------------	-----------

RAPID ROPE RECOVERY

Retrieve cable 5x as fast as standard mode on other Polaris winches. Get back to riding or complete your task quicker.



NOT AVAILABLE

AUTO STOP TECHNOLOGY

Auto Stop technology protects and extends the life of your winch by automatically stopping the winch at the end of pull to prevent over-spooling.



WIRELESS STANDARD, WIRED OPTION

AUTO STOP UPGRADE + WIRELESS REMOTE
2889840

SYNTHETIC ROPE REQUIRED

WIRELESS REMOTE

Operate your winch wirelessly from within 50 ft of the vehicle.

PREMIUM SYNTHETIC ROPE

Lightweight, extremely strong and flexible 50 ft long rope stands up to any tough job.



ADD SYNTHETIC ROPE
2878888

MODEL	2,041 KG	1,588 KG	ADD REQUIRED CABLES
SP 570 '22-25 CREW SP 570 '22-25	2885096	TOP SELLER 2885095	2-SEAT & CREW MODELS 2889185

UPGRADE YOUR CONTROLS HD OR PRO HD WINCHES

WIRED REMOTE CONTROL

- Kit includes remote handle and socket
- » REMOTE HANDLE & SOCKET KIT 2889600

NEW WIRELESS WINCH REMOTE

- Add convenience and safety to your integrated winch system
- Capable of operating the winch from up to 50-feet away
- Avoid tangled cables and eliminate the risk of damaged control cables
- » 2889840

SP 570 '22-25

POWER CONTROLLER

- Control your winch and plow hydraulics directly from the shift knob
- » 2889162

SP 570 '22-25



*The FM Frequency range is from 88 to 108 and only on the odds (i.e. 88.1, 88.3, etc.).

RANGER SP 570

STORAGE



Exclusive and available on all Polaris vehicles, Lock & Ride accessories let you quickly change from one task to another with hundreds of options.

With the flip of a lever, Lock & Ride plungers use outward pressure to expand for a secure fit.



LR SPARE TIRE CARRIER

- Includes one spare tire carrier
- Quick installation
- Tire carrier mounts to the rear cab to keep cargo bed free and easily accessible
- Maximum tire size supported is 30"

» 2889193

SP 570 '22-25, CREW SP 570 '22-25



LR STORAGE BOX

- Provides enough room to store all the tools you need to get the job done
- Internal organizational dividers keep gear from rolling around
- Easily detaches from vehicle

» 2889199

SP 570 '22-25, CREW SP 570 '22-25



HEADACHE RACK TOP SELLER

- Provides extreme cargo versatility to your UTV
- Strong steel tube construction for maximum durability

» 2889538

SP 570 '22-25, CREW SP 570 '22-25



CARGO BED MAT

- Protects cargo box, reduces drivetrain noise, and keeps cargo more secure with non-slip design
- Thick (3.18 mm) rubber mat construction

» 2889189

SP 570 '22-25, CREW SP 570 '22-25



LR BED EXTENDER/ DIVIDER TOP SELLER

- Increase your cargo capacity and UTV storage
- Extend the cargo bed or divide cargo within the bed
- Lock & Ride technology for easy install without tools
- Made from durable steel and powder-coated finish

» 2889183

SP 570 '22-25, CREW SP 570 '22-25



LR FRONT HOOD STORAGE RACK

- Increases storage and protects against brush and debris
- Steel construction with a durable powder-coated finish
- Lock & Ride functions for easy install, on and off maneuvering of the basket, and under-hood access
- Weight Capacity: 100 lbs.

» 2885088

SP 570 '22-25, CREW SP 570 '22-25
NOT COMPATIBLE WITH UPPER BRUSH GUARD (2885084) AS IT USES SAME MOUNTING POINTS
NORDIC PRO MODELS ONLY. BASE MODELS REQUIRE 1026432-458
NOT COMPATIBLE WITH 2885084



LR TOOL RACK

- Attach on the inside or outside of the cargo bed

» 2881533

SP 570 '22-25, CREW SP 570 '22-25



300 LB. REAR CARGO BOX WINCH

- 300 lb. pull force winch that mounts to rear headache rack
- Allows for easy loading of big game or other large and heavy items in the bed

» 2890134

SP 570 '22-25, CREW SP 570 '22-25
REQUIRES HEADACHE RACK (2889538), SOLD SEPARATELY



LR D-RINGS TOP SELLER

- The most versatile Lock & Ride accessory: add as many as you need to secure your cargo with bungee cords or straps

» 2881545

SP 570 '22-25, CREW SP 570 '22-25



FIRE EXTINGUISHER HOLDER

- Quick-release strap allows for easy access

» 2882158

SP 570 '22-25, CREW SP 570 '22-25



TRASH CAN HAULER

- Receiver mounted trash can hauler that allows slow speed towing of 2 trash cans
- Ideal for hauling cans down long driveways

» 2889876

SP 570 '22-25, CREW SP 570 '22-25



LR CHAINSAW MOUNT

» 2879354

SP 570 '22-25, CREW SP 570 '22-25



RANGER SP 570

ROOFS

WINDSHIELDS & REAR PANELS

CAB COMFORT & CONVENIENCE

AUDIO & WINCHES

STORAGE & PROTECTION

MAINTENANCE PARTS & FLUIDS



UPPER FRONT BRUSHGUARD

- Made from tubular steel and provides additional protection for front fenders and headlights
- Attaches to stock front bumper
- Durable, scratch-resistant, black powder-coat finish

» 2885084

SP 570 '22-25, CREW SP 570 '22-25
 FITS PREMIUM MODELS ONLY
 NOT COMPATIBLE WITH HOOD RACK (2885088)
 USES SAME MOUNTING LOCATIONS
 REQUIRES PREMIUM WELD-BUMPER (1026432-458), SOLD SEPARATELY
 NORDIC PRO MODELS ONLY. BASE MODELS REQUIRE 1026432-458
 NOT COMPATIBLE WITH 2885088

REAR BRUSHGUARD

- Made from tubular steel and provides additional protection for taillights
- Durable, scratch-resistant, black powder-coat finish
- Reliably enhances back-end protection of vehicle

» 2885087

SP 570 '22-25, CREW SP 570 '22-25

ROCK GUARD WITH STEP

- Reliable, hard-working protection for edges of vehicle
- Mounts directly to the frame, instead of underneath, for maximum ground clearance

» 2-SEAT (SHOWN) • 2889180
 SP 570 '22-25

» CREW • 2889181
 CREW SP 570 '22-25

A-ARM GUARDS

- Valuable, reliable protection for vital front suspension components exposed to the rigors of off-road environments
- Strong, durable, lightweight polyethylene construction withstands off-road impacts to protect the A-Arms

» FRONT (SHOWN) • 2885097
 » REAR • 2880551

SP 570 '22-25, CREW SP 570 '22-25
 NOT COMPATIBLE WITH MODELS THAT HAVE FRONT SWAY BAR

STRAPS

3.8 CM X 4.6 M 2494.0 KG RATCHET STRAP

- Heavy-duty webbing
- 2 pack

» 2884031



QUICKSTRAP

- The quickest and most secure way to mount Polaris accessories
- Sold as a pair

» 2882187

ALL COOLERS, RANGER CARGO BOXES



5.1 CM X 6.1 M 4535.9 KG RATCHET STRAP

- Heavy-duty webbing

» 2884032



DO MORE:



COOLERS P. 72



HUNT P. 70



COLD WEATHER P. 58



LIGHTING P. 62

RANGER SP 570

MAINTENANCE PARTS & FLUIDS



POLARIS ENGINEERED PARTS AND OIL have been validated and tested extensively, specifically for your vehicle. In order to maintain the peak performance of your Polaris vehicle only use official Polaris Engineered parts and oil.



We're taking the passion of our riders, workers, and outdoor enthusiasts to the next level with HD Parts. These Heavy Duty parts are engineered for riders who want greater durability and enhanced performance. HD Parts are designed and tested to handle greater wear and tear under all weather conditions.

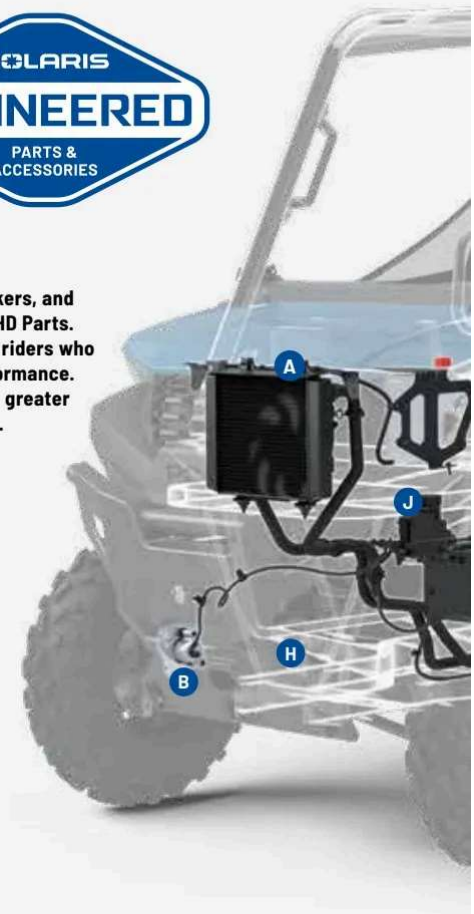

A DRIVE BELT
» 3211218



B BRAKE PADS
» 2203318
» **HD** • 2208936



C OIL FILTER
» 2540086
» **HD** • 2522485



D BATTERY
» 4015591



E AIR FILTER
» 7082037



F SPARK PLUG
» 3022662

LOOKING FOR MORE SERVICE PARTS?
See P. 113 to learn how to find parts for your model.

MAINTENANCE SCHEDULE*

BREAK-IN MAINTENANCE

FIRST 25 HRS | 500 MI / 800 KM

- ENGINE OIL & OIL FILTER CHANGE
- BATTERY TEST & CLEAN
REPLACE AS NEEDED
- FRONT GEARCASE CHANGE FLUID
- TRANSMISSION FLUID INSPECT
ADD LUBRICANTS AS NEEDED

12 MONTHS

200 HRS | 2,000 MI / 3,200 KM

- BRAKE FLUID INSPECT
ADD AS NEEDED
- BRAKE PADS INSPECT
REPLACE AS NEEDED
- ENGINE OIL & OIL FILTER CHANGE
- FRONT GEARCASE CHANGE FLUID
- GENERAL LUBRICATION ALL FITTINGS, PIVOTS, CABLES, ETC.

24 MONTHS

400 HRS | 4,000 MI / 6,400 KM

- BRAKE FLUID CHANGE
- BRAKE PADS INSPECT
REPLACE AS NEEDED
- ENGINE OIL & OIL FILTER CHANGE
- FRONT GEARCASE CHANGE FLUID
- GENERAL LUBRICATION ALL FITTINGS, PIVOTS, CABLES, ETC.
- SPARK PLUGS INSPECT
REPLACE AS NEEDED



G
ENGINE OIL P. 84
 » PS-4 • 1L • 502484
 » PS-4 • 4 L • 502485
 » PS-4 EXTREME • 1L • 503220
 » PS-4 EXTREME • 4 L • 503221



H
DEMAND DRIVE FLUID
 For front gearcase
 » 1L • 502563
 » 25 L • 502564
 » 200 L • 502565



I
AGL
 For transmission
 » 1L • 502505
 » 25 L • 502507
 » 200 L • 502508



J
DOT 4 BRAKE FLUID
 » 250 ML • 502526



ALL-SEASON GREASE TUBE
 » 400 G • 502538

MAINTENANCE MADE EASY



OIL CHANGE KITS
 2 L Engine Oil, 1 Oil Filter (2540086)
 » PS-4 • 502541

Claims made based off testing and performance of Polaris HD Parts against standard OEM parts made by Polaris and competitor brands under normal use. For more information regarding Polaris HD parts including vehicle compatibility, installation and maintenance, please contact your authorized Polaris ORV dealer.

36 MONTHS

600 HRS | 6,000 MI / 9,700 KM

FOR A COMPLETE MAINTENANCE SCHEDULE, CHECK YOUR OWNER'S MANUAL

- AIR FILTER**
REPLACE
- BATTERY**
TEST & CLEAN
REPLACE AS NEEDED
- DRIVE BELT**
INSPECT
REPLACE AS NEEDED
- HD MODELS ONLY
TRANSMISSION
CHANGE FLUID

- BRAKE FLUID**
INSPECT
ADD AS NEEDED
- BRAKE PADS**
INSPECT
REPLACE AS NEEDED
- ENGINE OIL & OIL FILTER**
CHANGE
- FRONT GEARCASE**
CHANGE FLUID
- GENERAL LUBRICATION**
ALL FITTINGS, PIVOTS,
CABLES, ETC.

- SPARK PLUGS**
INSPECT
REPLACE AS NEEDED
- AIR FILTER**
REPLACE
- BATTERY**
TEST & CLEAN
REPLACE AS NEEDED
- DRIVE BELT**
INSPECT
REPLACE AS NEEDED
- HD MODELS ONLY
TRANSMISSION
CHANGE FLUID

*This is a sample maintenance schedule. Please reference and use your owners manual for full maintenance and vehicle care.



YOUTH

RANGER 150 EFI



YOUTH CRAWLER TIRE

- Premium durability to ride longer
 - Increased ground clearance and performance
 - » 22" x 8" R12 • 5416945
 - » 22" x 10" R12 • 5416944
- 150 EFI 18-25



YOUTH BUCKLE WHEEL

- » FRONT • 12" x 7" • 1524114
 - » REAR • 12" x 8" • 1524115
- 150 EFI 18-25



PRO ARMOR WHEEL & TIRE KIT: YOUTH CRAWLER & BUCKLE

- » 2885154
- 150 EFI 18-25



FULL WINDSHIELD - POLY

- .32 cm clear poly carbonate
 - Mounts with Lock & Ride
- » 2889854
- 150 EFI 18-25



HALF WINDSHIELD - POLY

- 33 cm tall to provide protection and allow airflow
 - .32 cm clear poly carbonate
 - Mounts with Lock & Ride
- » 2889855
- 150 EFI 18-25

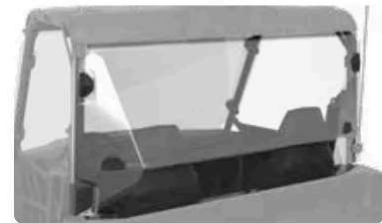

REAR PANEL - POLY

- .32 cm clear poly carbonate
 - Mounts with Lock & Ride
- » 2889856
- 150 EFI 18-25



FRONT & REAR BRUSHGUARD SET

- Durable, e-coated steel construction
 - Front and rear brushguard included
- » 2883287
- 150 EFI 18-25



SPORT ROOF - POLY

- Stay protected from rain, snow and sun
 - Easily installs
- » 2883289
- 150 EFI 18-25

The use of vehicles by youth in similar environments in your jurisdiction may be prohibited per locally applicable laws and regulations. Keep your children safe and make sure an adult exercises close supervision at all times.

MAINTENANCE PARTS & FLUIDS



POLARIS ENGINEERED PARTS AND OIL have been validated and tested extensively, specifically for your vehicle. In order to maintain the peak performance of your Polaris vehicle only use official Polaris Engineered parts and oil.



DRIVE BELT
» 3050270
150 EFI '18-25



BRAKE PADS
» FRONT • 1912970
» REAR • 1912971
150 EFI '18-25



OIL FILTER
» 3023344
150 EFI '18-25



BATTERY
» 4010678
150 EFI '18-25



AIR FILTER
» 7082249
150 EFI '18-25



SPARK PLUGS
» 3050051
150 EFI '18-25



ENGINE OIL
SEE P. 84 FOR DETAILS



ANGLE DRIVE FLUID
» 1L • 503320
» 25 L • 503318
» 202 L • 503317



DEMAND DRIVE FLUID
» 1L • 502563
» 25 L • 502564
» 200 L • 502565



AGL
» 1L • 502505
» 25 L • 502507
» 200 L • 502508



DOT 4 BRAKE FLUID
» 250 ML • 502526



ALL-SEASON GREASE TUBE
» 400 G • 502538

MAINTENANCE SCHEDULE*

BREAK-IN MAINTENANCE

- FIRST 5 HRS | 50 MI / 80 KM**
- ENGINE OIL & OIL FILTER CHANGE
 - DRIVE CHAIN ADJUST & LUBRICATE
 - BRAKE PAD INSPECT
REPLACE AS NEEDED

6 MONTHS

- 25 HRS | 500 MI / 800 KM**
- ENGINE OIL & OIL FILTER CHANGE
 - BATTERY TEST & CLEAN
REPLACE AS NEEDED
 - GENERAL LUBRICATION
ALL FITTINGS, PIVOTS, CABLES, ETC.

12 MONTHS

- 50 HRS | 1000 MI / 1600 KM**
- ENGINE OIL & OIL FILTER CHANGE
 - BATTERY TEST & CLEAN
REPLACE AS NEEDED

18 MONTHS

- 75 HRS | 1,500 MI / 2,500 KM**
- ENGINE OIL & OIL FILTER CHANGE
 - BATTERY TEST & CLEAN
REPLACE AS NEEDED

24 MONTHS

- 100 HRS | 2,000 MI / 3,200 KM**
- ENGINE OIL & OIL FILTER CHANGE
 - TRANSMISSION CHANGE FLUID
 - SPARK PLUG INSPECT
REPLACE AS NEEDED
 - DRIVE BELT INSPECT
REPLACE AS NEEDED
 - BATTERY TEST & CLEAN
REPLACE AS NEEDED

FOR A COMPLETE MAINTENANCE SCHEDULE, CHECK YOUR OWNER'S MANUAL

*This is a sample maintenance schedule. Please reference and use your owners manual for full maintenance and vehicle care.

WINCHES

DEPENDABLE. TOUGH. BUILT FOR THE OFF-ROAD.

A Polaris Engineered winch is designed to help you get the job done right, get you on your way faster and prepare you for the unexpected.

WHY POLARIS?

Polaris Off Road vehicles are engineered with designated mounting points and wiring for seamless install of Polaris Engineered winches.



TESTED **1,200+** PULLS AT MAX LOAD



BUILT TO WITHSTAND **-29° C** TEMPERATURES



OPERATES **FULLY SUBMERGED**



MILITARY TESTED & APPROVED



ADD A PLOW P. 58

FEATURES & BENEFITS

ALL POLARIS ENGINEERED WINCHES COME WITH:

- ✓ INTEGRATED WIRING, MOUNT, PREASSEMBLED
- ✓ HOOK WITH STRAP
- ✓ CUT STEEL GEARS & SEALED DRIVETRAIN
- ✓ SEALED PERMANENT MAGNET MOTOR



Retrieve cable 5x as fast as standard mode on other Polaris winches. Get back to riding or complete your task quicker.

1. Set winch dial to N (Neutral) to manually pull the rope out and secure the hook to your anchor point
2. Set winch dial to L (Low) for maximum pulling power while winching your load
3. Set winch dial to H (High) for retrieving the rope 5x faster with Rapid Rope Recovery



Auto Stop technology protects and extends the life of your winch by automatically stopping the winch at the end of pull to prevent over-spooling. While plowing, it prevents the plow frame from bending by stopping the winch once the plow has been lifted.



With its lightweight, yet extremely strong, design and superior flexibility, this 15.2 m long synthetic rope is easy to handle and can stand up to any tough job.



This convenient remote operates your Polaris winch wirelessly from within 15.2 m of the vehicle. Operate your winch safely outside your vehicle while on the job site or trails.

UPGRADE YOUR CONTROLS

DASH WINCH SWITCH KIT

- Allows user to add a dash switch as an additional means to control winch
- Compatible with all winches and other control methods (wireless/wired)

› 2889050

XP 1000 '18-25, CREW XP 1000 '18-25, CREW 1000 '20-25, 1000 '20-25, XP KINETIC '23-24, DIESEL '20-25

TOP SELLER

POWER CONTROLLER

- Control winch/plow hydraulics from shift knob

› 2883247 (SHOWN)

XP 1000 '18-25, CREW XP 1000 '18-25, CREW 1000 '20-25, 1000 '20-25, DIESEL '20-25

REQUIRES WINCH ADAPTER (2884159), SOLD SEPARATELY, WHEN USING A WINCH FOR LIFTING DEVICE

› 2889162

SP 570 '22-25

› 2879227

EV '15-21, CREW 570-4 '14-21, 570 FULL SIZE '17-25, 570 '11-25, 500 '17-22



WIRED REMOTE CONTROL

- Handle and socket both required

› REMOTE HANDLE • 4013466

› SOCKET • 4017102

WORKS WITH 2889695

› SOCKET • 4014228

WORKS WITH 2885095 & 2881669

WIRELESS WINCH REMOTE

- Add convenience and safety to your integrated winch system

- Capable of operating the winch from up to 50-feet away

- Avoid tangled cables and eliminate the risk of damaged control cables

› 2889840

SP 570 '22-25

REPLACEMENT PARTS

SYNTHETIC ROPE

› 2,722 KG
2879188

› 1,588 KG
2879187



STEEL CABLE

› 1,588 KG
2878890



MODEL

XP 1000/CREW XP 1000 '18-25

1000/CREW 1000 '20-25

XP KINETIC '23-24

DIESEL '20-25

NON EPS RANGER 1000 REQUIRES FRONT BUMPER

SP 570/CREW SP 570 '22-25

2-SEAT & CREW MODELS REQUIRE CABLES: 2889185



TOP-OF-THE-LINE FEATURES
BEST FOR PLOWING, HEAVY-DUTY OUTDOOR CHORES & TRAIL RIDING

PRO HD SERIES



BUILT FOR THE OFF-ROAD
BEST FOR THE CASUAL OFF-ROAD RIDER

HD SERIES

WINCHES

PLOWS

LIGHTING

CONNECTED TECHNOLOGY

ELECTRICAL ACCESSORIES

TRACKS

HUNT

COOLERS

WHEELS & TIRES & TRAILERING



NOT AVAILABLE



ADD AUTO STOP TECHNOLOGY

2889690
WORKS WITH KITS 2889695
SYNTHETIC ROPE REQUIRED

**AUTO STOP UPGRADE
+ WIRELESS REMOTE**
2890991
WORKS WITH 2889275
SYNTHETIC ROPE REQUIRED



2881693
WORKS WITH 2885095 & 2881669
SYNTHETIC ROPE REQUIRED

ADD SYNTHETIC ROPE

2879187



2878888

ADD WIRELESS REMOTE

TOP SELLER 2883455
ONLY WORKS WITH 2889695

**AUTO STOP UPGRADE
+ WIRELESS REMOTE**
2890991
ONLY WORKS WITH 2889275
SYNTHETIC ROPE REQUIRED



2879316
WORKS WITH 2885095 & 2881669

2,722 KG	2,041 KG	2,041 KG	1,588 KG
2889693	TOP SELLER 2889694	TOP SELLER 2889695 High-Mounted 2889272	
	2885096		TOP SELLER 2885095

GLACIER PLOW SYSTEMS



HYDRAULIC CONTROL FOR EXTREME SNOW REMOVAL

A robust frame and tough blades, combined with a convenient hydraulic angle system, allow your Glacier Pro HD to move serious snow while you remain comfortable. Thanks to Lock & Ride technology, the Pro HD comes standard with a convenient kickstand attachment to the plow frame, giving you the easiest attachment.

1000 / XP 1000 / XP KINETIC / DIESEL **183 cm or 213 cm blades*** **Choice of poly or steel*** **Hydraulic lift & angle system option**

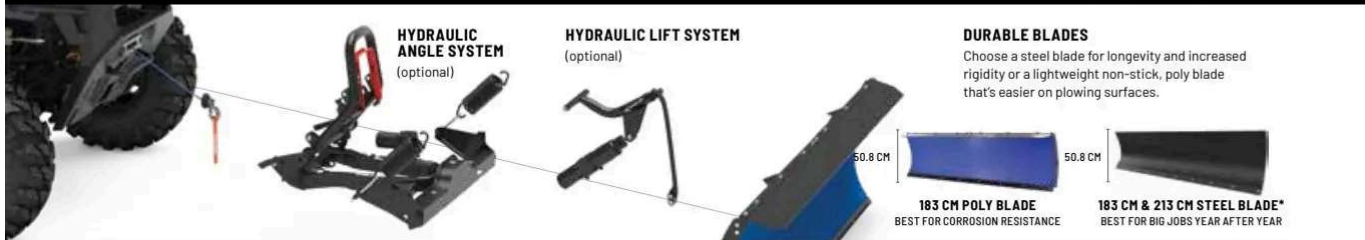

BUILD YOUR PLOW SYSTEM	STEP 1 SELECT A MOUNT	STEP 2 SELECT A FRAME	STEP 3 SELECT PLOW CONTROL		STEP 4 SELECT A BLADE
MODELS	MOUNT	FRAME	HYDRAULICS	WINCHES	BLADES
XP 1000 '18-25 CREW XP 1000 '19-25 1000 '20-25 CREW 1000 '20-25 XP KINETIC '23-24 DIESEL '20-25	Not Required INTEGRATED INTO FACTORY BUMPER NON EPS RANGER 1000 REQUIRES FRONT BUMPER	Frame 2889308 Track Extension 2879871 Replacement T Shear Pin 2204829 Glacier Pro HD Kickstand System 2207382	Hydraulic Lift System 2889058 Glacier Pro HD Plow Hydraulic Angle System 2889029 TOP SELLER Power Controller 2883247 REQUIRED FOR HYDRAULIC COMPONENTS	Polaris Pro HD 2,722 kg Winch 2889693 TOP SELLER Polaris Pro HD 2,041 kg Winch 2889694 Power Controller Winch Adapter 2884159	183 cm Poly 2879317 TOP SELLER 183 cm Steel 2890334

PLOW ACCESSORIES

PLOW BLADE SNOW DEFLECTOR

- » 183 CM - 2858541
- » 168 CM - 2879866
- » 152 CM - 2871808

HEAVY-DUTY SNOW PLOW DEFLECTOR

- » 183 CM - 2884160

QUICK RELEASE SKID SHOES

- Helps prevent blade wear
- Hardened steel for industrial strength
- » 2205223

COIL SPRING SPACER

- Keep the front end of the vehicle up and improve ride quality when using a plow on strut or A-Arm vehicles
- » 2872655

GLACIER 15.3 CM PLOW EXTENSIONS

- 15.3 cm steel plow extensions that attach to the side of 168 cm and 183 cm Glacier Pro HD plows
- » 2889328



COMMON ACCESSORIES

WINCHES

PLOWS

LIGHTING

CONNECTED TECHNOLOGY

ELECTRICAL ACCESSORIES

TRACKS

HUNT

COOLERS

WHEELS & TIRES & TRAILERING

SP 570 / 570 / 500 / 570 FULL-SIZE

183 cm or 168 cm blades

Choice of poly or steel

Hydraulic angle system option



BUILD A PLOW SYSTEM

BUILD YOUR PLOW SYSTEM	STEP 1 SELECT A MOUNT	STEP 2 SELECT A FRAME	STEP 3 SELECT PLOW CONTROL	STEP 4 SELECT A BLADE
MODELS	MOUNT	FRAME	HYDRAULICS	WINCH
570 FULL-SIZE '16-25 CREW 570 FULL-SIZE '16-25 500 '17-22 570 '10-21 CREW 570 '10-21 LI-ION EV '15-21 EV '15-21	Mount & Quick Release Hook 2880261	TOP SELLER Frame 2880260 Frame Extension 2880267	Glacier Pro HD Plow Hydraulic Angle System 2889032 Power Controller 2879227 NO SHIFTER TO MOUNT CONTROLLER ON EV REQUIRED FOR HYDRAULIC COMPONENTS	Polaris Pro HD 2,041 kg Winch 2882238 TOP SELLER 183 cm Steel 2890335
SP 570 '22-25 CREW SP 570 '22-25 PREMIUM AND NORTHSTAR EDITION MODELS	Quick Release Hook 2889577 REQUIRED FOR ALL TRIMS MOUNT INTEGRATED INTO FRONT BUMPER	FOR VEHICLES USING TRACK SYSTEM Replacement Shear Pin 2205527	Glacier Pro HD Plow Hydraulic Angle System 2889032 Power Controller 2889162 NO SHIFTER TO MOUNT CONTROLLER ON EV REQUIRED FOR HYDRAULIC COMPONENTS	Polaris Pro HD 2,041 kg Winch 2885096 TOP SELLER 168 cm Steel 2890336
SP 570 '22-25 CREW SP 570 '22-25	Mount 2889195 Quick Release Hook 2889577			168 cm Poly 2880269

WEAR BARS

- Protect your plow blade and minimize wear on the actual blade

- » 183 CM STEEL • 2204976
- » 183 CM HD STEEL • 2879875
- » 183 CM UHMWPE • 2890289
- » 168 CM STEEL • 2879867
- » 168 CM HD STEEL • 2879868
- » 152 CM STEEL • 2877243
- » 168 CM UHMWPE • 2890290

PLOW BACK DRAG BAR

- Has a hinged, rear facing cutting edge that improves back dragging performance and allows the bar to float when plowing forward to reduce wear and tear

- » 183 CM • 2889329
- » 152 CM • 2889747

NOT COMPATIBLE WITH 66" BLADES

QUICK RELEASE SKID SHOES

- Helps prevent blade wear
- Hardened steel for industrial strength

- » 2208864

PLOW MARKER

- Helps driver monitor plow blade position
- Sold in pairs

- » 2872726

PLOW LINK

- » 2204974

GLACIER PLOW SYSTEMS

MAKE QUICK WORK OF THE SMALLER JOBS

Move some snow with the sturdy and capable Glacier HD plow system, and discover why a major snowfall can be the highlight of your week. With a robust frame, beefy poly and steel blade options, convenient Lock & Ride mounting and dismounting and amazing value, Glacier HD is a great choice in the dead of winter.

3-SEAT & CREW

183 cm or
168 cm blades

Choice of
poly or steel

Manual angle
system standard

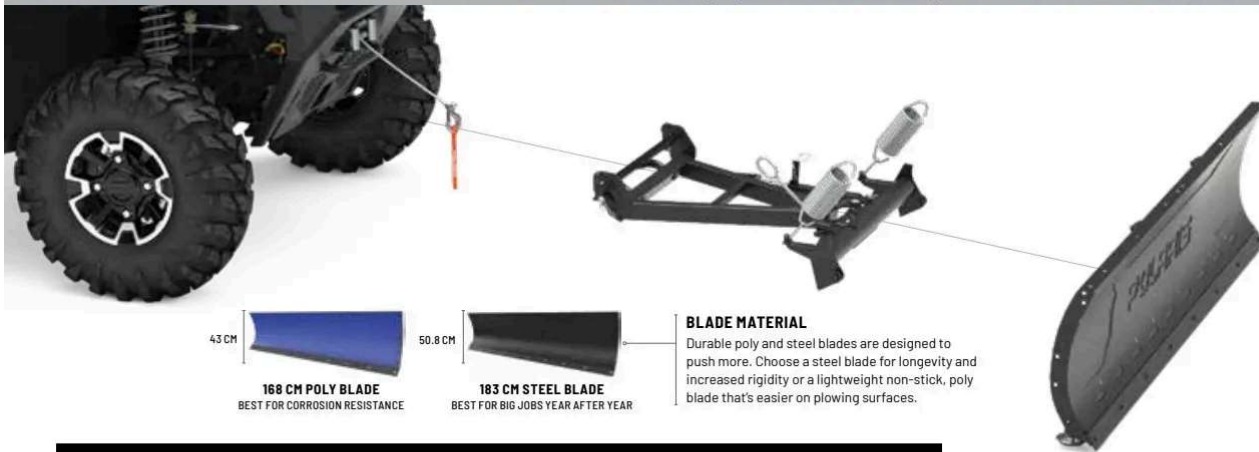

43 CM
168 CM POLY BLADE
BEST FOR CORROSION RESISTANCE

50.8 CM
183 CM STEEL BLADE
BEST FOR BIG JOBS YEAR AFTER YEAR

BLADE MATERIAL
Durable poly and steel blades are designed to push more. Choose a steel blade for longevity and increased rigidity or a lightweight non-stick, poly blade that's easier on plowing surfaces.

BUILD A PLOW SYSTEM

	STEP 1 SELECT A MOUNT	STEP 2 SELECT A FRAME	STEP 3 SELECT A LIFT METHOD	STEP 4 SELECT A BLADE
MODELS	MOUNT	FRAME	WINCHES	BLADES
XP 1000 '18-25 CREW XP 1000 '19-25 1000 '20-25 CREW 1000 '20-25 XP KINETIC '23-24 DIESEL '20-25 <small>NOT COMPATIBLE WITH 28" OR LARGER TIRES</small>	<p>Not Required INTEGRATED INTO FACTORY BRUSHGUARD</p> <p>NON EPS RANGER 1000 REQUIRES FRONT BUMPER</p>	<p>Frame 2889307</p> <p>Replacement Shear Pin 2205527</p>	<p>TOP SELLER Polaris HD 2,041kg Winch 2889695</p>	<p>TOP SELLER 183 cm Steel 2890335</p> <p>168 cm Poly 2880269</p> <p>TOP SELLER 168 cm Steel 2890336</p>

PLOW ACCESSORIES

WEAR BARS

- Protect your plow blade and minimize wear on the actual blade
- » 183 CM STEEL • 2204976
- » 183 CM HD STEEL • 2879875
- » 168 CM STEEL • 2879867
- » 168 CM HD STEEL • 2879868
- » 152 CM STEEL • 2877243

PLOW BLADE SNOW DEFLECTOR

- » 183 CM • 2858541
- » 168 CM • 2879866
- » 152 CM • 2871808

HEAVY-DUTY SNOW PLOW DEFLECTOR

- » 183 CM • 2884160

QUICK RELEASE SKID SHOES

- Helps prevent blade wear
- Hardened steel for industrial strength
- » 2208864



2-SEAT & CREW 570 FULL-SIZE & CREW

168 cm blades

Choice of poly or steel

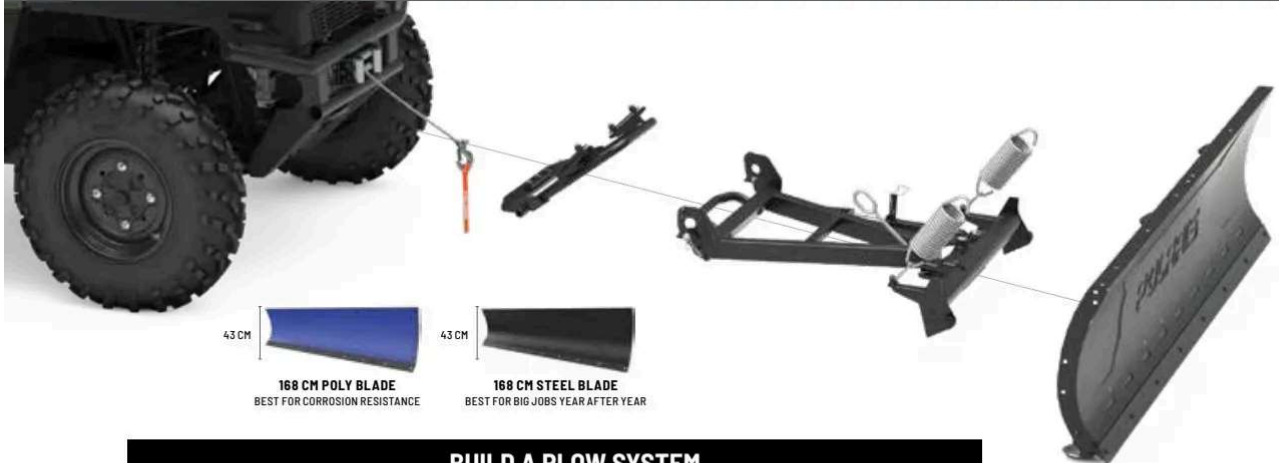

BUILD A PLOW SYSTEM				
	STEP 1 SELECT A MOUNT	STEP 2 SELECT A FRAME	STEP 3 SELECT A LIFT METHOD	STEP 4 SELECT A BLADE
MODELS	MOUNT	FRAME	WINCHES	BLADES
570 FULL-SIZE '16-25 CREW 570 FULL-SIZE '16-25 500/ETX '10-22 570 '10-21 CREW 570 '10-21 LI-ION EV '15-21 EV '15-21	Mount 2879105	Frame 2889307	TOP SELLER Polaris HD 1,588 kg Winch 2881669	168 cm Poly 2880269
SP 570 '22-25 CREW SP 570 '22-25	Mount 2889195 NOT REQUIRED ON PREMIUM AND NORTHSTAR EDITION MODELS	Replacement Shear Pin 2205527	Polaris Pro HD 2,041 kg Winch 2885096	TOP SELLER 168 cm Steel 2890336

COIL SPRING SPACER

- Keep the front end of the vehicle up and improve ride quality when using a plow on strut or A-Arm vehicles
- » 2872655

QUICK RELEASE SKID SHOES

- Helps prevent blade wear
 - Hardened steel for industrial strength
- » 2208864

PLOW MARKER

- Helps driver monitor plow blade position
 - Sold in pairs
- » 2872726

GLACIER PLOW LINK

» 2204974



POLARIS ENGINEERED ADVANTAGES

MOUNTS PERFECTLY
Designed for your Polaris Engineered bumper, roof or other mounting point

ADVANCED TECH

RIGID lights are driven by Aluminum PCB Smart Boards, 6063-T5 aircraft aluminum extruded housings and Tiger Drylac UV protection polyester powdercoating.

EXCLUSIVE OPTICS

RIGID lights feature impact-resistant polycarbonate lenses for a 100% water/dustproof seal.



LIGHT BAR TYPES



SR-SERIES PRO

Sleek, powerful, low-profile (under 5 cm tall). Lights extreme distances with low energy usage.

Available in 25 cm & 81 cm



D-SERIES PRO

Compact to fit almost anywhere with high output and low energy usage.

Available in Driving, Flood & Spot



BUILD YOUR VISION

Consider the optics, angle and how you will use your vehicle to choose the right light or set of lights.

OPTICS LIGHT ANGLE	ACCENT	DRIVING (45°)	FLOOD (25°)	SPOT (10°)	COMBO (25°/10°)
DRIVING SPEED	All	Slow to medium	Slow to medium	High	All
BEAM	Diffused glow	Extra-wide	Wide/shorter	Concentrated/long	Inner spot & outer flood
RECOMMENDED MOUNTING	Low/wheel well	All points	Low/rear	High points	All points
TERRAIN & RIDING STYLE	Added style & personalization in any terrain	All riding & utility	Wide-open terrain or trails & utility	Trail & tight conditions	All riding & utility

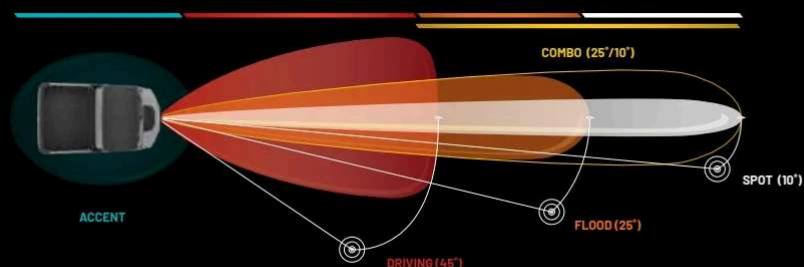

MAX PERFORMANCE

Validated to work as hard as your machine does

DOESN'T OVERTAX

Trust it to work when you need it to

PRO ARMOR



RUGGED CONSTRUCTION

Pro Armor lights are designed to be big and beefy with an aggressive style all their own, and housed in IP67 marine-grade rated UV polyester powdercoating.

MASSIVELY BRIGHT

Pro Armor builds bright lights designed for any riding experience. All that power is directed through heat dissipating aluminum for streamlined heat management.



DUAL-ROW LED

The most spread and farthest illumination downrange. Easy to mount.

Available in 27.9 cm & 78.7 cm



SINGLE-ROW LED

Powerful, compact, low-profile light bars with sleek look.

Available in 27.9 cm, 50.8 cm, 84 cm & 102 cm



CUBE LED

Small size allows mounting in strategic locations for added lighting.

Available in Spot

COMBO

OPTICS



RIGID 81 CM
SR-SERIES
20,064
2884299*



RIGID 25 CM
SR-SERIES
7,920
2883123*

Universal mounting only



PRO ARMOR 102 CM
SINGLE-ROW
7,600
2889793



PRO ARMOR 84 CM
SINGLE-ROW
7,500
2889791



PRO ARMOR 78.7 CM
DUAL-ROW
13,500
2889790



PRO ARMOR 50.8 CM
SINGLE-ROW
4,700
2889792

1,200 m
960 m
720 m
480 m
240 m

BRAND SIZE
TYPE
RAW LUMENS
PN

*Not available in Europe

ADD A HARNESS TO MOUNT YOUR LIGHTS

MODELS	LIGHT BAR SET-UPS	
	1 LIGHT IN 1 LOCATION ON 1 SWITCH	2 LIGHTS IN 2 LOCATIONS ON 1 SWITCH
EV 15-21 CREW 570-4 15-21 570 15-21 500 17-22	<p>TOP SELLER</p> <p>LIGHT BAR HARNESS 2882209</p> <p>UPPER SWITCH PANEL LIGHT BAR HARNESS* 2889675</p> <p>⚠️ REQUIRES BATTERY CONNECTION CABLE</p>	<p>TOP SELLER</p> <p>LIGHT BAR HARNESS 2882209</p> <p>Y-HARNESS 2879860</p> <p>⚠️ REQUIRES BATTERY CONNECTION CABLE</p>
SP 570 22-25 NON-PREMIUM AND NON-NORTHSTAR MODELS REQUIRE BATTERY CONNECTION CABLE	SEE P. 66 FOR WIRING CONNECTIONS	
XP 1000 18-25 CREW XP 1000 18-25 1000 20-25 CREW 1000 20-25 XP KINE TIC 23-24		

⚠️ BATTERY CONNECTION CABLES

3-SEAT & CREW

- 3-SEAT • 2879388
XP 1000 17-25
- CREW • 2879685
CREW XP 1000 17-25

2-SEAT & CREW

- **TOP SELLER** 2-SEAT • 2879990
EV 15-21, 570 15-21, 500 17-22
- CREW • 2880929
CREW 570-4 15-21
- 570 • 2881684
EV 15-21, 570 15-21, 500 17-22
- SP 570 • 2889185
SP 570 SPORT 22-25,
CREW SP 570 SPORT 22-25

1 LED LIGHT BAR WIRING HARNESS - REAR FACING CREW EXTENSION

- For installing rear facing light on Crew models
- 2883854
XP 1000 20-25, CREW XP 1000 19-25,
CREW 1000 20-25
TO BE USED WITH LIGHT BAR HARNESS (2889675)

LIGHT BAR MOUNT

- Optional cast mount for added style
- Compatible with all Pro Armor light bars
- 2890053

ADD ADDITIONAL EXTERNAL LIGHTING P. 24

COMMON ACCESSORIES

WHEELS

PLOWS

LIGHTING

CONNECTED TECHNOLOGY

ELECTRICAL ACCESSORIES

TRACKS

HUNT

COOLERS

WHEELS & TIRES & TRAILERING

CONNECTED TECHNOLOGY

SMART TECH TO
OUTSMART THE UNEXPECTED

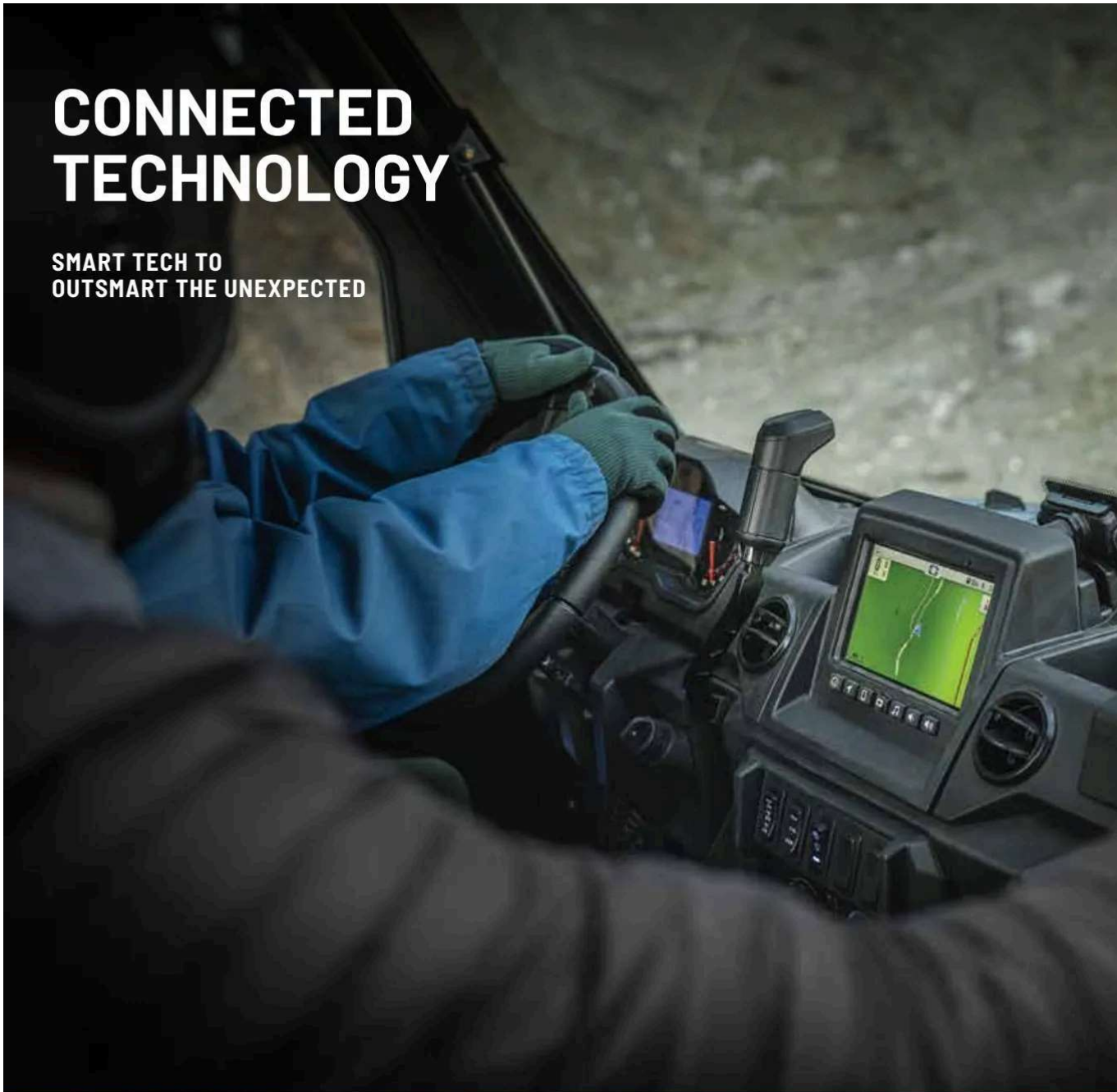

POLARIS RIDECOMMAND

PLAN YOUR RIDE

Figure out your route ahead of time, so you can spend more time doing and less time planning. With Snap-to-Trail technology and property lines, you can ensure you're in the right area.

TUNE IN TO YOUR SURROUNDINGS

Integrated rear cameras and Game Camera Viewer allows you to have a more comprehensive view of your surroundings so you can check out what is happening on your land.

WORK SMARTER

Plow Mode automatically raises and lowers the plow depending on the gear you're in so that you can get your work done quicker.

DISCOVER NEW TRAILS

With over 1,000,000 miles of trails available offline, you'll have the confidence to ride anywhere, whether you have cellular coverage or not.



COMMON ACCESSORIES

WHEELS

PLOWS

LIGHTING

CONNECTED TECHNOLOGY

ELECTRICAL ACCESSORIES

TRACKS

HUNT

COOLERS

WHEELS & TIRES & TRAILERING

AVAILABLE ON SELECT MODELS & AS AN ACCESSORY

7" DISPLAY POWERED BY RIDE COMMAND

Bright, 7" touchscreen visible in all conditions.

Group Ride

Stay together with fellow riders by following them directly on the map screen so you can ride at your own speed.

» 2884072

XP1000 ABS TRACTOR '25, XP 1000 '19-24, CREW XP 1000 '19-24, CREW 1000 '20-25, 1000 '20-25, DIESEL '20-25, SP 570 '22-25, CREW SP 570 '22-25

SPEAKERS NOT INCLUDED, MUST CHOOSE AUDIO PACKAGE FOR AUDIO OUTPUT

» 2890898

XP 1000 NON-ABS '25, CREW XP 1000 '25, XP KINETIC '24

SPEAKERS NOT INCLUDED, MUST CHOOSE AUDIO PACKAGE FOR AUDIO OUTPUT

Personalized Audio Experience

Seamlessly pair to your display via Bluetooth to wirelessly stream music and stay connected with call and text alerts.

Configurable Gauges

Customize your ride experience with elevation, travel direction, fuel level and more to create relevant screens for you.

7" DISPLAY MOUNT KIT

- Necessary mount for 7" Display Powered by RIDE COMMAND
- Seamless fit and finish
- Includes necessary wiring harness and reverse camera kits

» 2890286

CREW 1000 '25, 1000 '25, DIESEL '25

» 2889310

XP KINETIC '24

» 2889309

XP 1000 '22-24, CREW XP 1000 '22-24, CREW 1000 '22-24, 1000 '22-24, DIESEL '22-24

» 2890287

XP 1000 '25, CREW XP 1000 '25

» 2889163

SP 570 '22-25

CAMERA KITS

» FRONT • 2889662

XP KINETIC '24, SEE FULL DETAILS ON P. 39

ELECTRICAL ACCESSORIES



ADD ELECTRICAL SYSTEM ACCESSORIES IN 4 EASY STEPS

Polaris PULSE is a revolutionary way to provide additional power locations on your vehicle, and makes adding electrical accessories a snap. Electrical accessories are easier to install, with designated routing areas and plug and play connections.

Look for  to identify Polaris PULSE ready accessories.

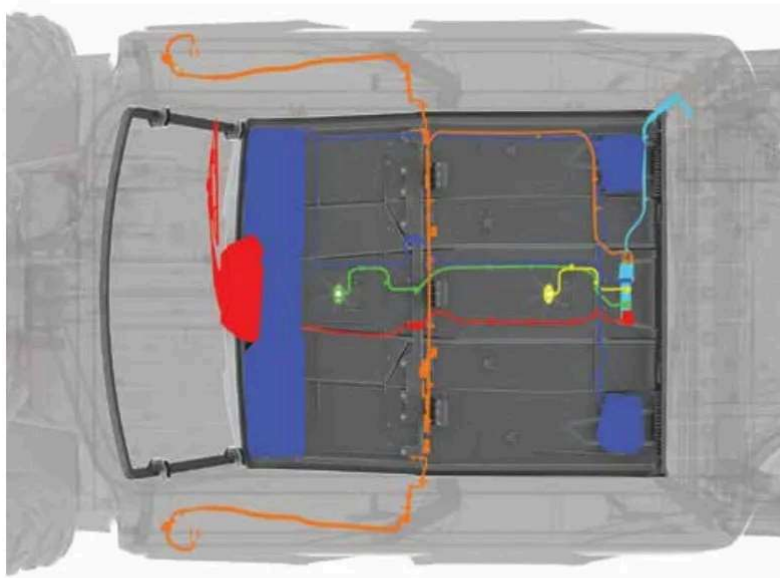

CREW XP 1000 POLARIS PULSE WIRING SHOWN



STEP 1

CHOOSE A POLARIS PULSE READY ROOF	1000 XP 1000 XP KINETIC	CREW 1000 XP 1000	SP 570	CREW SP 570
Premium Roof - Poly - Polaris Pursuit Camo	2882913	N/A	N/A	
Premium Roof - Poly - Black	2882912	N/A	N/A	
Sport Roof - Poly - Black	2890684	2890333	2885077	2885078

STEP 2

ADD THE POLARIS PULSE ROOF 6	1000 XP 1000 XP KINETIC	CREW 1000 XP 1000	SP 570	CREW SP 570
Polaris PULSE Roof 6	2882904			
Polaris PULSE Wiring Harness - Crew Extension	N/A		2889185	

STEP 3 ADD ACCESSORIES*

POWER WINDOW DOORS	1000 XP 1000 XP KINETIC	CREW 1000 XP 1000	SP 570	CREW SP 570
Polaris PULSE Wiring Harness - Crew Extension	N/A		2883231	

WINDSHIELD WIPER & WASHER SYSTEM	1000 XP 1000 XP KINETIC	CREW 1000 XP 1000	SP 570	CREW SP 570
Windshield Wiper & Washer System	2883974		2885083	
Polaris PULSE Wiring Harness - Crew Extension	N/A		2883231	

WORK LIGHT	1000 XP 1000 XP KINETIC	CREW 1000 XP 1000	SP 570	CREW SP 570
Rear LED Work Light	2889672			
Reverse Light Harness	2889679		N/A	
Polaris PULSE Wiring Harness - Crew Extension	N/A		2883231	

AUDIO: DASH RADIO & VISOR SPEAKERS	1000 XP 1000 XP KINETIC	CREW 1000 XP 1000	SP 570	CREW SP 570
160 Watt, Waterproof AM/FM Bluetooth Audio System ***	2882750		N/A	
300 Watt Overhead Audio Visor Speakers ***	2882891 [†]		N/A	
JBL Dash Audio Kit	N/A		2885081	
Polaris PULSE Wiring Harness - Crew Extension	N/A		2883231	

AUDIO: VISOR AUDIO + REAR SPEAKERS	1000 XP 1000 XP KINETIC	CREW 1000 XP 1000	SP 570	CREW SP 570
300 Watt AM/FM, Bluetooth Audio Visor with Four 16.5 cm Waterproof Speakers ***	2882888		N/A	
Rear Overhead Speakers	2882876		N/A	
JBL® Trail Pro 4200 Audio Upgrade Kit	N/A		N/A	
Polaris PULSE Wiring Harness - Crew Extension	N/A		2883231	

*Add accessories to models without 7" Display Powered by RIDE COMMAND

STEP 4 FINISHING TOUCH

CONCEAL WIRING FOR A FINISHED, COMFORTABLE LOOK	1000 XP 1000 XP KINETIC	CREW 1000 XP 1000	SP 570	CREW SP 570
Premium Roof Liner	2890526	2890527	2885093	2885094

*** The FM Frequency range is from 88 to 108 and only on the odds (i.e. 88.1, 88.3, etc.). † Not available in Europe.

ELECTRICAL ACCESSORIES



THE FOLLOWING ACCESSORIES EASILY PLUG INTO THE FACTORY INSTALLED POLARIS PULSE UNDER THE HOOD:

	1000 / XP 1000 / XP KINETIC	SP 570
Heater & Defrost System	P. 22 / 39	P. 48
Horn	P. 24	P. 48
Plow Controller	P. 25	P. 49
Audio System	P. 28	P. 49
Light Bars	P. 62	P. 62



POLARIS PULSE UNDERHOOD BUS BAR - 6 POSITION

- If upgrading to more than three accessories attaching to the underhood PULSE location, replace 3-Position Bus Bar with the Polaris PULSE Underhood Bus Bar - 6 Position

» **2884183** 1000 ONLY
CREW 1000 '20-25, 1000 '20-25, DIESEL '20-25

POLARIS FRONT PULSE BAR AND HARNESS

- This kit is required to install any electrical accessories on a base RANGER SP 570

» **2889185**
SP 570 '22 (STANDARD ON '23-25)

POLARIS PULSE BATTERY TENDER ADAPTER

- Connects your trickle charger to your vehicle

» **2884297**
XP 1000 '18-25, CREW XP 1000 '18-25, CREW 1000 '20-25, 1000 '20-25, SP 570 '22-25, CREW SP 570 '22-25, XP KINETIC '23-24, DIESEL '20-25

REVERSE LIGHT HARNESS

- Activates rear lights when your RANGER is shifted into reverse

» **2889679**
XP 1000 '17-25, CREW XP 1000 '18-25, CREW 1000 '20-25, 1000 '20-25, XP KINETIC '23-24



EASILY ADD LIGHTING

With Polaris PULSE it's easy to add RIGID® and Pro Armor lighting to your RANGER. All LED Light bars listed on pages 62-63 are Polaris PULSE ready, making installation that much easier.

POLARIS PULSE LIGHT BAR WIRING LOCATIONS

- Front Bumper
- Roof - Front Mounted
- Roof - Rear Mounted
- CREW Roof - Rear Mounted*

*Requires Extension

1000 / XP 1000 / XP KINETIC	SP 570
<p>TOP SELLER</p> <p>Polaris PULSE Wiring Harness - 1 LED Light Bar 2883230</p> <p>Upper Switch Panel Light Bar Harness** 2889675</p> <p>Reverse Light Harness 2889679</p>	<p>Polaris PULSE Wiring Harness - 1 LED Light Bar 2889161</p>
<p>TOP SELLER</p> <p>Polaris PULSE Wiring Harness - 1 LED Light Bar 2883230</p> <p>Y-Harness 2879860</p>	N/A
<p>TOP SELLER</p> <p>Polaris PULSE Wiring Harness - 1 LED Light Bar (x2) 2883230</p>	<p>Polaris PULSE Wiring Harness - 1 LED Light Bar (x2) 2889161</p>
<p>Polaris PULSE Wiring Harness - 1 LED Light Bar - Crew Extension 2883231</p> <p>Upper Switch Panel Light Bar Harness - Extension** 2890067</p>	N/A



- COMMON ACCESSORIES
- WINCHES
- PLOWS
- LIGHTING
- CONNECTED TECHNOLOGY
- ELECTRICAL ACCESSORIES
- TRACKS
- HUNT
- COOLERS
- WHEELS & TIRES & TRAILERING

PROSPECTOR[®] PRO TRACK SYSTEM

PROSPECTOR PRO TRACK MOUNT KIT

• Install this track system mounting hardware in place of tires and wheels. Tracks sold separately.

» 2889425

XP 1000 '21-25, CREW XP 1000 '21-25, CREW 1000 '20-25, 1000 '21-25, DIESEL '20-25
FITS MODELS WITH NON-HIGH CLEARANCE A-ARMS

» 2889426

XP 1000 '21-25, CREW XP 1000 '21-25
FITS MODELS WITH HIGH CLEARANCE A-ARMS

» 2882783

XP 1000 '18-21, CREW XP 1000 '18-21, CREW 1000 '20-21, 1000 '20-21

» 2880071

CREW 570-4 '15-21, 570 '14-21, 500 '17-22

» 2889196

SP 570 '22-25
REQUIRES PROSPECTOR PRO TRACK (2880758), SOLD SEPARATELY

PROSPECTOR PRO 2.0 TRACK

» 2890034

XP 1000 '18-25, CREW XP 1000 '18-25, CREW 1000 '20-25, 1000 '20-25, DIESEL '20-25

» 2889487

SP 570 '22-25, CREW SP 570 '22-25

PROSPECTOR PRO TRACK

» 2880758

570 '14-21 WITH EPS, CREW 570 '14-21 WITH EPS

» 2880757

CREW 570-4 '14-21, 570 '14-21, 500 '17-22

If using Glacier Pro Plow System with tracks, Track Plow Extension is required (2889287)

For year-round use, Polaris recommends the use of Intake Update Kit (2880673) on any RANGER XP 1000 '17, RANGER XP 1000 CREW '14-18 with tracks installed. To keep intake system working optimally, this kit pre-filters out fine snow and dust.



1 INDUSTRY-FIRST FLEX-TRACK DESIGN

Front-mounted tracks with flexible sides and a slight inward curve allow for stable handling, a more comfortable ride and precise steering over long-distances or extended working hours.

2 HIGH-DENSITY TIRE WITH ADJUSTED SHAPE

With puncture-proof tires that reduce friction and wear, the Prospect Pro 2.0 Tracks delivers trouble-free performance.

Confidently take on bumps and obstacles with 8" high-density tracks.

3 LIGHTWEIGHT POWDER COAT STEEL FRAME

Proven geometry to improve durability and deliver capability in all conditions throughout the life of the tracks.

A lighter frame provides more flotation to stay on top of the snow and allows the tracks to easily shed the elements they encounter.

4 TANDEM STABILIZER

The bolt-on, tandem mid-roller wheel provides a smoother ride by absorbing shocks.

5 BEARING HOUSING

Outer seals and stainless steel sleeves allow stronger bearing durability and greater reliability.

6 WHEEL CAP & SEAL

A fitted wheel cap with bladder effect eliminates water absorption due to temperature variation. Ride in snow or mud without worrying about track maintenance.



KOLPIN STRONGHOLD SYSTEM

Polaris is proud to partner with Kolpin Outdoors, an industry leader in off-road accessories and the premier name in gun boots and mounts. If you need to secure a firearm while riding, simply attach the auto-latch mount and choose your Gun Boot.

IDEAL FOR SECURE TRANSPORT OF SCOPED RIFLES AND SHOTGUNS.

STEP 1 CHOOSE YOUR MOUNT



KOLPIN STRONGHOLD AUTO-LATCH DOUBLE BOOT MOUNT

- Precision angle adjustable for a custom fit
 - Provides a quick and secure attachment point
- » **DOUBLE BOOT MOUNT • 2883970**
 » **SINGLE BOOT MOUNT • 2884106**



RHINO-RACK - GUN BOOT MOUNT

- Bracket used to mount Kolpin Stronghold Gun Boots to Rhino-Rack systems when paired with Auto-Latch Mount (2884106), sold separately
- » **2889327**
 XP 1000 '18-25, CREW XP 1000 '19-25, CREW 1000 '20-25, 1000 '20-25, DIESEL '20-25
 REQUIRES AUTO-LATCH MOUNT 2884106 TO MOUNT TO VEHICLE
 SEE P. 32 FOR MORE RHINO-RACK PRODUCTS

STEP 2 CHOOSE YOUR BOOTS



KOLPIN STRONGHOLD GUN BOOT XL TOP SELLER

- Lockable and TSA approved
 - Includes padded, zippered internal protective liner
- 132 cm L x 9.5 cm W x 26.7 cm H
 » **2882036**
 REQUIRES AUTO-LATCH MOUNT 2883970 OR 2884106 TO MOUNT TO VEHICLE

KOLPIN STRONGHOLD GUN BOOT L TOP SELLER

- 132 cm L x 12 cm W x 23.5 cm H
- » **2882426**
 REQUIRES AUTO-LATCH MOUNT 2883970 OR 2884106 TO MOUNT TO VEHICLE

KOLPIN GUN RACK 6

- Adjustable to store guns at an angle or vertical (shown at angle)
 - Holds six rifles or shotguns securely with soft rubber v-grips
 - Stock is secured in place with a soft molded rubber inlay along the bottom of the rack
 - Rack can be adjusted into three positions based on firearm height
- » **2882159**
 XP 1000 '17-25, CREW XP 1000 '18-25, CREW 570 FULL SIZE '18-25, CREW 1000 '20-25, 570 FULL SIZE '17-25, 1000 '20-25, DIESEL '20-25





ADD A REAR WINCH SO YOUR RANGER WORKS HARDER THAN YOU DO

RANGER 1000 / XP 1000 / DIESEL P. 35
RANGER SP 570 P. 50



KOLPIN RHINO GRIPS

IDEAL FOR CARRYING RIFLES, SHOTGUNS, BOWS AND CROSSBOWS

LR LR MAX RHINO GRIP PRO

- » 2884107
- » REPLACEMENT RUBBER STRAPS (2) • 2884109
- ALL RANGER MODELS (EXCEPT 150 EFI)



LR LR MAX TOP SELLER RATCHETING RHINO GRIP

- » 2881575
- ALL RANGER MODELS (EXCEPT 150 EFI)



LR LR MAX RHINO GRIP XLR

- » 2889165
- » REPLACEMENT RUBBER STRAPS (2) • 2889204
- ALL RANGER MODELS (EXCEPT 150 EFI)



LR LR MAX RHINO GRIP XLR - DOUBLES

- » 2889166
- » REPLACEMENT RUBBER STRAPS (2) • 2889204
- ALL RANGER MODELS (EXCEPT 150 EFI)



All Kolpin Rhino Grips are Lock & Ride and Lock & Ride MAX compatible and come with required mounting hardware.

IN-CAB GUN MOUNT

- Gives you instant gun access in the field
- Mounts securely to the floor and adjusts up to 45° forward
- Robust, molded gun butt holder at base
- Quick-release barrel straps
- Easily removable
- Accommodates scope-equipped rifles

» 2883263

XP 1000 '18-25, CREW XP 1000 '19-25, CREW 1000 '20-25, 1000 '20-25, DIESEL '20-25
NORTHSTAR EDITION REQUIRES 2208023 HWD KIT TO INSTALL ON THE 2019 AND NEWER MODELS



POLARIS PURSUIT CAMO SxS FIELD COVER

- Full-coverage camo print cover hides your side-by-side while in the field
- Lightweight material protects your RANGER from inclement weather

- » 2882160
- XP 1000 '18-25, EV '15-21, 570 FULL SIZE '17-25, 570 '11-25, SP 570 '22-25, 600 '17-22, 1000 '20-25, DIESEL '20-25

Never transport a loaded firearm. Verify firearm is unloaded prior to mounting. Please refer to local laws and regulations regarding the requirements for the legal transport of firearms.

COMMON ACCESSORIES

WINCHES

PLOWS

LIGHTING

CONNECTED TECHNOLOGY

ELECTRICAL ACCESSORIES

TRACKS

HUNT

COOLERS

WHEELS & TIRES & TRAILERING

COOLERS



MADE FOR RIDERS.
BUILT FOR LIFE.

28, 57 & 99
LITER FEATURES



ComfortCarry
Handles



TravelLock
System



EasyOut
Drain System



NoSlip
Rubber Feet



PolarWall
Insulation



IceLock
Seal



99 LITER

SAGEBRUSH GREEN • 2890707
GRAPHITE • 2883426

ACCESSORIES

WIRE BASKET • 2883648
DIVIDER (1) • 2883468
WHEELS • 2883967

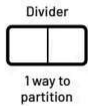

57 LITER

SAGEBRUSH GREEN • 2890706
GRAPHITE • 2883425

ACCESSORIES

WIRE BASKET • 2882185
DIVIDERS (2) • 2882184
SEAT CUSHION • 2882179
WHEELS • 2882180



28 LITER

SAGEBRUSH GREEN • 2890705
GRAPHITE • 2883424

ACCESSORIES

WIRE BASKET • 2882438
DIVIDER (1) • 2882186

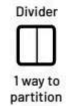

ESSENTIAL ACCESSORIES SO YOUR COOLER WORKS AS HARD AS YOU DO





POLARIS NORTHSTAR COOLERS CAN SURVIVE JUST ABOUT ANYTHING - FROM EXTREME HEAT TO A NASTY TUMBLE OFF A VEHICLE.



14 LITER
SAGEBRUSH GREEN • 2890704
GRAPHITE • 2883968



19 LITER SOFT-SIDED COOLER
GRAPHITE • 2889285



HOLDS ICE FOR AGES

BECAUSE JUST ANY COOLER WON'T CUT IT OUT THERE.

You need something rugged and reliable. A cooler purpose-built to handle the challenges of the off-road—while keeping your provisions on ice for days on end. Because out here, there are no ice machines, and you just left the last one in your dust. So, load it up. Lock it in. And know your NorthStar cooler is staying put—giving you a few extra days of ice time to enjoy the wild.



QUICKSTRAP



LR 2882187

ALL COOLERS AND POLARIS RANGER CARGO BOXES

WHEELS & TIRES



PRO ARMOR

**OFF-ROAD, IT'S ALL ABOUT
FREEDOM & CREATING
YOUR OWN PATH**

As serious riders ourselves, we get it. And everything we design is to get (and keep) you going on the ride of a lifetime. We're for every style of rider looking to go beyond the expected with a ride that will make your story epic.





WHY CHOOSE PRO ARMOR?

SUPERIOR PERFORMANCE & DURABILITY

LIFELONG PERFORMANCE

- Every tire is designed and constructed with **longevity** in mind
- **3,000+ mile rated** (4,828 kilometers)

PREMIUM PROTECTION

- Pro Armor makes tires with **extra protection** exactly where it's needed most – the sidewall
- **Triple-belted sidewalls** keep your tires more resistant so you can keep going
Many competitors only use double-belted sidewalls

TOUGH TIRES

- Higher ply ratings mean added protection
- Pro Armor builds 8 or 10-ply rated tires for **higher puncture-resistance**

For off-road use only. Please check fitment with your dealer.



COMMON ACCESSORIES

WINCHES

PLOWS

LIGHTING

CONNECTED TECHNOLOGY

ELECTRICAL ACCESSORIES

TRACKS

HUNT

COOLERS

WHEELS & TIRES & TAILORING

TIRES

Developed and tested with Polaris engineers, ensuring the perfect fit and optimal performance mile after mile.



PRO ARMOR X TERRAIN - E-MARKED

Handle anything the trail throws your way, with a durability-driven design that provides a comfortable and confident ride.

Why Choose X Terrain?

Triple-belted sidewall resists puncture.

PRO ARMOR PRESERVE

Turf-friendly for areas requiring low-impact from treads.

Why Choose Preserve?

Perfect for locations where you don't want to risk damaging turf.

PRO ARMOR HARVESTER

Designed for trail & agricultural applications with excellent grip, minimal crop impact and long wear life.

Why Choose Harvester?

Great for unexpected impact and rugged terrain.



PRO ARMOR XD-K

These heavy duty tires are one of the strongest we've ever built. Superior puncture resistance, ride quality and long life.

Why Choose XD-K?

Triple-belted sidewall resists puncture.

PRO ARMOR HD-K

One of the strongest Pro Armor tires. Ride through corn stalks, thorns, jagged rocks or whatever else comes your way.

Why Choose HD-K?

Extremely strong tire for long life.

DUAL-COMPOUND

PRO ARMOR MUD XC

The best tread design that balances aggressive traction in the mud with a smoother ride on the trail.

Why Choose Mud XC?

Perfect mud-trail crossover.



PRO ARMOR TIRES HAVE BEEN DEVELOPED AND TESTED to ensure the perfect fit, superior durability and optimal performance, mile-after-mile. No matter where you ride - mud, dirt, sand or snow - we've got you covered.



15" WHEEL

DUAL-DUROMETER

PRO ARMOR ATTACK 2.0

All purpose tread pattern with a 10-ply radial construction provides excellent traction and increased durability.

Why Choose Attack 2.0?

Tighter lug spacing provides better traction in hard-pack & 10-ply construction provides long-lasting durability.



14" WHEEL

PRO ARMOR ATTACK

Aggressive tread design provides traction in any environment.

Why Choose Attack?

Great all-season tire with wider lug spacing for grip in softer terrain.



12" WHEEL
14" WHEEL

PRO ARMOR TREKKER

The best balance of on-trail handling and low tire noise.

Why Choose Trekker?

Ultimate predictability with a quiet ride.



14" WHEEL

DUAL-DUROMETER

PRO ARMOR DUAL-THREAT

Dual compound technology for superior grip and traction.

Why Choose Dual-Threat?

Softer outer lugs for cornering grip and feel; harder inner lugs for longer tread life.



14" WHEEL
16" WHEEL

DUAL-DUROMETER

PRO ARMOR CRAWLER XG

Unmatched grip for rock crawling with a taller, softer lug.

Why Choose Crawler XG?

Perfect balance between high-speed performance, durability and flex for traction on slick rocks.



14" WHEEL

SINGLE-DUROMETER

PRO ARMOR CRAWLER XR

Premium grip for most terrains, from desert trails to the rocks.

Why Choose Crawler XR?

Tougher durometer allows for a shorter lug without sacrificing tread life and saves weight. Excels in hard-pack, fast terrain.



For off-road use only. Please check fitment with your dealer.



KNOW YOUR TERRAIN



- Tread patterns optimized for extreme traction
- Ideal for both hard pack & loose trail



- Provides traction & durability
- Performs in hard sand, jagged rocks or any extreme terrain



- Flexible "grippy" tread
- Aggressive side bite



- Extra deep treads
- Self-cleaning lugs



- Triple-belted sidewalls to resist puncture
- Purpose-built, long lasting tread patterns



- Handles extreme cold
- Holds shape & provides traction

WHEELS



15"

50-SERIES

A 5201

WEIGHT: 7.8 KG	LOAD RATING: 590 KG	OFFSET: +4
MATTE BLACK	FRONT/REAR	15" x 7"
1523184-458		

D 5204

WEIGHT: 6.1 KG	LOAD RATING: 590 KG	OFFSET: +5
MATTE BLACK	FRONT/REAR	15" x 7"
1522550-458		

B 5202

WEIGHT: 8.1 KG	LOAD RATING: 590 KG	OFFSET: +4
ACCENT	FRONT/REAR	15" x 7"
1523102-266		
MATTE BLACK	FRONT/REAR	15" x 7"
1523102-458		

E 5301 BEADLOCK

WEIGHT: 7.7 KG	LOAD RATING: 726 KG	OFFSET: +38
ACCENT	FRONT/REAR	15" x 7"
1523282		
MATTE BLACK	FRONT/REAR	15" x 7"
1523266		

C 5203 BEADLOCK

WEIGHT: 7.3 KG	LOAD RATING: 590 KG	OFFSET: +38
MATTE BLACK	FRONT/REAR	15" x 7"
1522435-458		

LUG NUTS REQUIRED P. 81

FORGED BEADLOCK RINGS

BEADLOCK REQUIRED



15" FORGED BEADLOCK RINGS

A MACHINED 1522240-266
ONLY USED ON 5203 BEADLOCK
SOLD INDIVIDUALLY

B MATTE BLACK 1523147-458
ONLY USED ON 5301 BEADLOCK
SOLD INDIVIDUALLY





14"

40-SERIES

J 4201 ○

	FRONT	WEIGHT:	5.9 KG	LOAD RATING:	408 KG	OFFSET:	+9
	REAR	WEIGHT:	6.4 KG	LOAD RATING:	590 KG	OFFSET:	+9
ACCENT	FRONT			14" x 7"			1522956-266
	REAR			14" x 8"			1522957-266
MATTE BLACK	FRONT			14" x 7"			1522956-458
	REAR			14" x 8"			1522957-458

K 4202 ○

	FRONT	WEIGHT:	5.8 KG	LOAD RATING:	408 KG	OFFSET:	+4
	REAR	WEIGHT:	6.1 KG	LOAD RATING:	590 KG	OFFSET:	-9
ACCENT	FRONT			14" x 7"			1522544-266
	REAR			14" x 8"			1522545-266
MATTE BLACK	FRONT			14" x 7"			1522544-458
	REAR			14" x 8"			1522545-458

L 4203 BEADLOCK ○○

	FRONT	WEIGHT:	5.9 KG	LOAD RATING:	408 KG	OFFSET:	+4
	REAR	WEIGHT:	6.6 KG	LOAD RATING:	590 KG	OFFSET:	-9
MATTE BLACK	FRONT			14" x 7"			1522238-458
	REAR			14" x 8"			1522239-458

M 4204 ○

	FRONT	WEIGHT:	5.9 KG	LOAD RATING:	408 KG	OFFSET:	+4
	REAR	WEIGHT:	6.4 KG	LOAD RATING:	590 KG	OFFSET:	-9
ACCENT	FRONT			14" x 7"			1522546-266
	REAR			14" x 8"			1522547-266
MATTE BLACK	FRONT			14" x 7"			1522546-458
	REAR			14" x 8"			1522547-458

N 4205 ○

	FRONT	WEIGHT:	4.8 KG	LOAD RATING:	408 KG	OFFSET:	+4
	REAR	WEIGHT: <td>5.7 KG</td> <td>LOAD RATING:</td> <td>590 KG</td> <td>OFFSET:</td> <td>-9</td>	5.7 KG	LOAD RATING:	590 KG	OFFSET:	-9
MATTE BLACK	FRONT			14" x 7"			1521507-521
	REAR			14" x 8"			1521508-521
LUSTER	FRONT			14" x 7"			1521507-410
	REAR			14" x 8"			1521508-410

O HD DUAL BEADLOCK

	FRONT	WEIGHT:	18.1 KG	LOAD RATING:	725.7 KG	OFFSET:	+38
MATTE BLACK	FRONT/REAR			14" x 7"			1524022-458

FORGED BEADLOCK RINGS

○ BEADLOCK REQUIRED



14" FORGED BEADLOCK RINGS

A MACHINED 1522244-266

ONLY USED ON 4203 BEADLOCK & HD DUAL BEADLOCK SOLD INDIVIDUALLY

B MATTE BLACK 1523146-458

ONLY USED ON 4301 BEADLOCK & HD DUAL BEADLOCK SOLD INDIVIDUALLY

KNOW YOUR WHEELS

STEP 1: SELECT YOUR SERIES

- 4 = 40-SERIES
- 5 = 50-SERIES

STEP 2: CHOOSE YOUR LOAD RATING

- 1 = <362.9 kg
- 2 = 363 - 589.7 kg
- 3 = 590 - 726+ kg

STEP 3: PICK YOUR STYLE

- OFFSET / BEADLOCK / COLOR
- INCREASE OFFSET FROM STOCK = NARROWER STANCE
 - DECREASE OFFSET FROM STOCK = WIDER STANCE

For off-road use only. Please check fitment with your dealer.

KNOW YOUR TERRAIN



- Tread patterns optimized for extreme traction
- Ideal for both hard pack and loose trail



- Flexible "grippy" tread
- Aggressive side bite



- Provides traction and durability
- Built to perform in hard sand, jagged rocks or any other extreme terrain

WHEEL & TIRE SETS

14" 40-SERIES	UTILITY			DESERT/ROCK	MUD/TRAIL		BACKCOUNTRY/TRAIL		
	HARVESTER 27"	28"	PRESERVE 27"	CRAWLER XR 28"	27"	MUD XC 29"	ATTACK 26"	DUAL-THREAT 26"	29"
4201 ○ ACCENT	2882388	2883225	2883208	2882394	2884272	2884265	2882390	2883138	2883146
4201 ○ MATTE BLACK	2882389	2883226	2883209	2882395	2884273	2884266	2882391	2883139	2883147
4202 ○ ACCENT	2882383	2883220	2883203	2881343	2884267	2884260	2881335	2883140	2883148
4202 ○ MATTE BLACK	2882384	2883221	2883204	2881344	2884268	2884261	2881336	2883141	2883149
4203 BEADLOCK MATTE BLACK <small>BEADLOCKS SOLD SEPARATELY</small>				2881386			2881381		
4204 ○ ACCENT	2882385	2883222	2883205	2881355	2884270	2884263	2881347	2883142	2883150
4204 ○ MATTE BLACK	2882386	2883223		2881356	2884271	2884264	2881348	2883143	2883151
4205 ○ LUSTER				2881371			2881359		
4205 ○ MATTE BLACK	2882387	2883224	2883207	2881372	2884269	2884262	2881360	2883144	2883152





- Extra deep treads
- Self-cleaning lugs



- Triple-belted sidewalls to resist puncture
- Purpose-built, long lasting tread patterns



- Handles extreme cold
- Holds shape and provides traction

COMMON ACCESSORIES

WINCHES

PLOWS

LIGHTING

CONNECTED TECHNOLOGY

ELECTRICAL ACCESSORIES

TRACKS

HUNT

COOLERS

WHEELS & TIRES & TRAILERING

TREKKER		X TERRAIN	
27"	29"	27"	29"
		2889966	2889976
		2889967	2889977
2890907	2890906	2889968	2889978
2890905	2890904	2889969	2889979
		2889972	2889982
		2889973	2889983
		2889974	2889984
		2889975	2889985

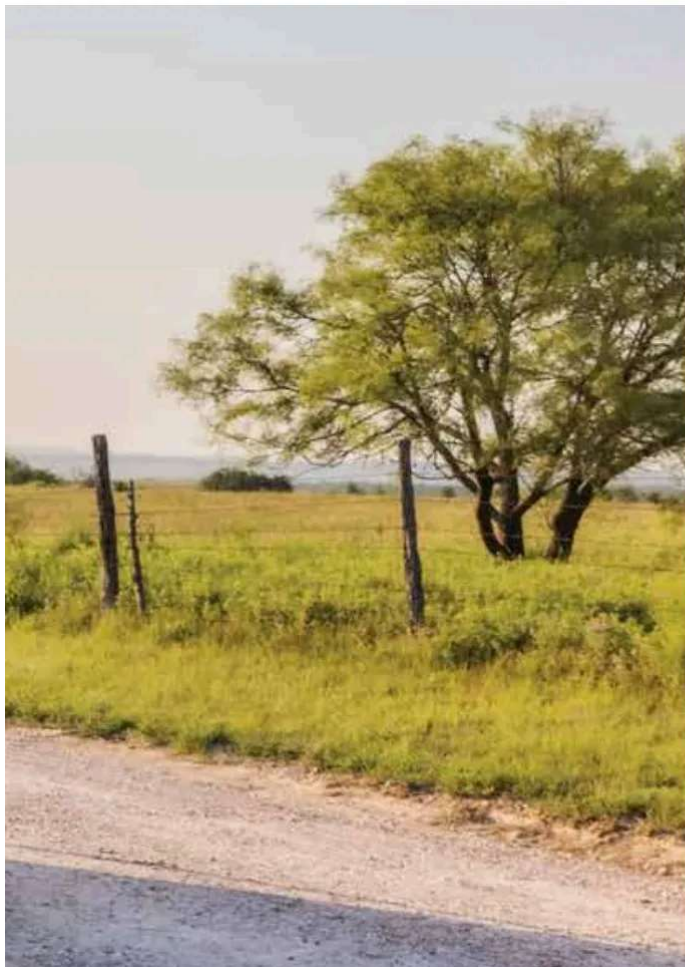

15" 50-SERIES	TRAIL	DESERT/ROCK
	ATTACK 2.0 28"	CRAWLER XG 28"
5201 ACCENT	2883160	2883188
5201 MATTE BLACK	2883159	2883187
5202 ACCENT	2883158	2883186
5202 MATTE BLACK	2883157	2883185
5203 BEADLOCK ACCENT <small>BEADLOCKS SOLD SEPARATELY</small>	2883154	2883182
5204 MATTE BLACK	2883155	2883183
5301 BEADLOCK ACCENT <small>BEADLOCKS PRE-MOUNTED</small>	2883162	2883190
5301 BEADLOCK MATTE BLACK <small>BEADLOCKS PRE-MOUNTED</small>	2883161	2883189

LUG NUTS LUG NUTS REQUIRED

12MM x 1.5 SPLINED LUG NUTS		
16 LUG NUTS WITH WRENCH	ALL POLARIS RANGER 3-SEAT & CREW MODELS	287933
4 LUG NUTS WITHOUT WRENCH		2879331
SPLINED LUG WRENCH		2204966



3/8" - 24 HEX LUG NUTS		
16 HEX LUG NUTS	ALL POLARIS RANGER 570/20-21 MODELS	2877409
4 HEX LUG NUTS		2876754



2 WAYS TO PURCHASE
INDIVIDUAL WHEELS & TIRES
- OR - COMPLETE SETS AS LISTED
 Exclusively at Polaris Authorized Dealers

For off-road use only. Please check fitment with your dealer.

CLEANERS

CLEAN

ALL-PURPOSE CLEANER

• Professional cleaner, which is formulated with a low pH-value. The product spreads well on surfaces and adheres on them for effective cleaning action. Perfectly compatible with rubber, plastic and painted surfaces. The formulation is biodegradable.

» 500 mL • 502309

SHINE

INSTANT SHINE & DETAILER

• The INSTANT SHINE AND DETAILER is developed for cleaning action without water. Removes insects, dust and dirt with almost no effort. Applicable for plastics, visors, windcreens, paint and metal. The wipe and shine formulation makes surfaces shine, works water repellent and also has an antistatic effect. Perfect for customers living in urban areas with no access to water, for bike trips or showroom bikes.

» 500 mL • 502546



TRAILERING

RAMPS



CALIBER RAMP PRO

- Designed for ATVs and UTVs up to 127 cm wide
 - Integrated grip glides for ultimate traction
 - Folding sides for easy transportation and storing
- » 132 CM × 229 CM • 2884576



ALUMINUM ARCHED LOADING RAMPS

- Capacity for up to 1,361 kg
- » 193 CM × 30.5 CM • 907 KG • 2875384
- » 224 CM × 30.5 CM • 1,361 KG • 2875386



LIGHTWEIGHT TRI-FOLD RAMPS

- Ramp folds up for transport
- Capacity for up to 680.7 kg
- Safety straps included
- » 183 CM × 130 CM • 2875385
- » 208 CM × 130 CM • 2875860



FOLDING ALUMINUM ARCHED RAMPS

- Ramp folds up for transport
 - Up to 680 kg total capacity, 340 kg per individual ramp
 - Safety straps included
- » 224 CM × 30.5 CM • 2875387

COVERS



TRAILERING COVERS

- Protect your vehicle from the elements while storing outdoors
- A ratchet strap system on the bottom helps to secure the cover to the vehicle

MID-SIZE

- » 2890329
SP 570 '22-25
- » 2890330
CREW SP 570 '22-25

FULL-SIZE

- » 2890331
XP 1000 '15-25, 1000 '20-25
- » 2890332
CREW XP 1000 '17-25, CREW 1000 '20-25
- » POLARIS PURSUIT CAMO • 2882160
XP 1000 '14-25, EV '15-21, 570 FULL-SIZE '17-25, 570 '14-25, 500 '17-22, 1000 '20-25

CV BOOT REPAIR KIT*

FIX ON THE GO | TEMPORARY COVERAGE

- A quick trail-side fix to increase trail time
- The flexible and durable boot material expands over a cone tool for CV boot repairs, without disassembling CV axles
- Universal fit – works as a temporary fix for most powersports axles
- All components fit inside the cone, and a cover is provided for compact durable storage
- Easily fits in a cargo box, attached to the roll cage, in the glovebox or many other storage locations



Items shown are contained inside cone

UTV CV BOOT REPAIR KIT

- Kit includes the following items:
- (1) Expandable XL CV Boot
 - (1) Reusable Cone Tool
 - (2) CV Boot Clamps
 - (1) Tube of Silicone Lube
 - (1) Grease Packet
 - (1) Cone Cover
- » 2830526

UTV TRAIL BOOT ONLY

» 2830527

ATV

- » CV REPAIR KIT 2830528
- » TRAIL BOOT ONLY 2830529

HOW TO INSTALL

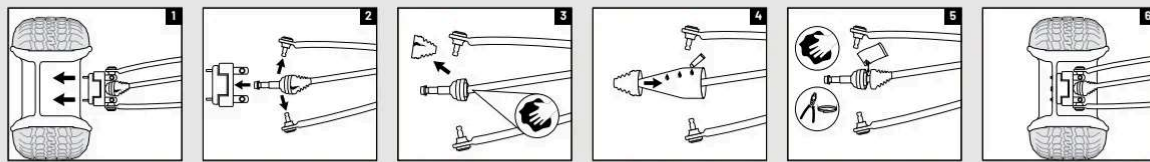

1 Remove wheel and axle nut.

2 Remove brake caliper, hub, tie rod and upper and lower ball joints.

3 Remove old boot and clean joint.

4 Spread silicone lube on entire cone tool. Slide boot over cone tool, large end first. See package for outer boot instructions.

5 Empty the bag of grease into the CV joint/boot, clean sealing points and install clamps.

6 Reassemble tie rod, ball joints, brake caliper, axle nut, tire and wheel.

Refer to your service manual for further instructions and torque specifications.
*Designed for temporary CV boot repair. Purchase the OEM CV Boot for a permanent repair.

HITCHES



HITCH WITH 5 CM BALL

- 3:1 Hitch: ball, hook and pin design
 - Rust resistant steel with powdercoat finish
 - Removable ball, HD 1.6 cm pin and clip
- » 5 CM x 5 CM RECEIVER • 2830522
» 3 CM x 3 CM RECEIVER • 2830523



4.8 CM BALL

- 4.8 cm replacement ball for hitch
 - Designed to work with 3:1 Hitch
- » 2830524



RECEIVER HITCH

- » 5 CM RECEIVER TONGUE 2875320



TRAILER BALL 1.9 CM SHANK

- » 4.8 CM BALL • 2877602
- » 5 CM BALL • 2877603

STRAPS & ROPES



RECOVERY STRAP

- 5 cm x 9.1 m
 - 8,165 kg maximum load, 4,082 kg maximum vehicle weight
 - Comes with carry bag
- » 2884033



RATCHET STRAP

- 3.8 cm x 4.6 m straps, 2 pack
 - Heavy duty webbing
 - 2,495 kg maximum load, 831 kg working load
- » 2884031



RATCHET STRAP

- 5 cm x 6.1 m
 - Heavy duty webbing, floating D-rings, double J-hooks
 - 4,536 kg maximum load, 1,497 kg working load
- » 2884032



SHOCK STRAPS

- 3.8 cm 1,361 kg breaking strength
 - Keeps tension on tie-down straps to secure load, 2 pack
- » 3.8 CM x 4.6 M • 2883296
» 3.8 CM x 2.1 M • 2883295

COMMON ACCESSORIES

WINCHES

PLOWES

LIGHTING

CONNECTED TECHNOLOGY

ELECTRICAL ACCESSORIES

TRACKS

HUNT

COOLERS

WHEELS & TIRES & TRAILERING



OIL & LUBRICANTS

Our PS-4 engine oils provide ultimate performance and protection, they're formulated with exclusive additives to keep engines clean from deposit buildup. These powersports-grade full synthetic oils helps maximize power and protect your engine for the long term.

**PS-4 FORMULATIONS
BEST PROTECTION,
BEST PERFORMANCE**

PS-4 5W-50 FULL-SYNTHETIC OIL

Optimal for ambient operating temperatures of -40° C to 38° C.

1L 502484	25L 502486	200L 502488
4L 502485	60L 502487	

PS-4 0W-50 EXTREME FULL-SYNTHETIC OIL

Optimal for ambient operating temperatures of -43° C to 54° C.

1L 503220	25L 503233	200L 503235
4L 503221	60L 503236	

POLARIS DIESEL HD

Synthetic performance oil, especially designed for work applications.

1L 502573	25L 502575	200L 502577
4L 502574	60L 502576	

PS-4 5W-50

OIL CHANGE KITS

These convenient kits include everything needed including filter and oil volume per vehicle

PART NUMBER	VEHICLE FITMENT
502541	SINGLE 570, TWIN 600, TWIN 700, TWIN 800
502543	RANGER/RZR/GENERAL 900/1000
502542	SPORTSMAN 570/1000

POLARIS INVESTS IN EACH OIL AT & ABOVE THESE LEVELS

**12+ DEDICATED
TEAM MEMBERS**
FOCUSED ON POLARIS OIL

**18+
MONTHS**
DEVELOPMENT & TESTING

**76,000+
HOURS**
DYNO TESTING

**3.5 MILLION+
KILOMETERS**
FIELD TESTING



DOT 4 BRAKE FLUID

A high-quality brake fluid designed for use in Polaris hydraulic brakes.
» 250 ML • 502526



ALL-SEASON GREASE TUBE

Specialized water-resistant lubricant
» 400 G • 502538



PREMIUM GAS SHOCK OIL

» 1 L • 502518



AGL

Protects transmission components against wear, corrosion, oxidation and foam in transmissions.

» 1 L • 502505
» 25 L • 502507
» 200 L • 502508



POLARIS
EXTREME
SYNTHETICS

PS-4 EXTREME SYNTHETIC 0W-50

- Our best extreme high and low temp formula, excellent for high temperatures and racing, even at temps of 54°C, plus easier cold starting even below -42°C
- Expect the best in wear protection thanks to premium PAO and ester base stocks combined with a balance of moly and ZDDP additives
- Polaris exclusive clean engine additive system reduces deposits and carbon build-up for peak performance and power

THE BEST PROTECTION, MAXIMUM PERFORMANCE

- Powersports grade full synthetics provide long lasting engine protection
- At least 40% improved wear protection compared to all aftermarket oils tested (see engine wear test chart)
- Polaris exclusive clean additive system
- At least 50% less deposits than all aftermarket oils tested (see deposit test chart)
- Cleaner engine with less deposits means consistent maximum power and performance

WIDEST VISCOSITY FOR ULTIMATE PROTECTION



ENGINE WEAR TEST

LOWER NUMBER = LESS ENGINE COMPONENT WEAR
LESS WEAR ON PARTS MEANS LONGER ENGINE LIFE

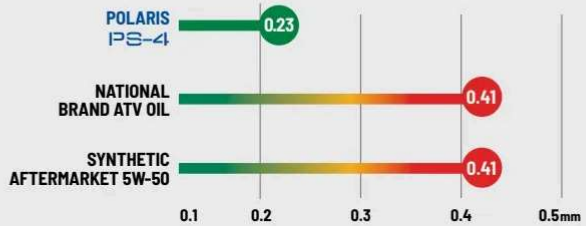

ASTM D4172. In 3rd party testing against 9 competitive products Polaris had 40% or better wear protection compared to all of the tested products. Numbers represent mm of wear scarring measured. Test measures wear at contact points, wear scar is measured for its length and width (in units of mm). Lower wear numbers mean better wear protection and friction reduction.

DEPOSIT TEST

LOWER DEPOSITS = MAXIMUM POWER

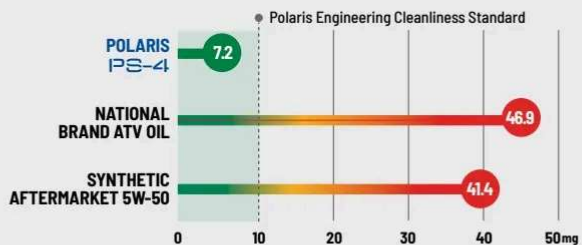

ASTM D6335. In 3rd party testing against 9 competitive products Polaris PS-4 had less than half the deposits compared to the next closest product. No other tested products met Polaris Engineering standards for deposit cleanliness. Test measures mass of deposits in mg in high temp, high stress test cycles. Higher deposits will impact engine power and performance.



DEMAND DRIVE FLUID

Proprietary formulation prevents clutch slippage and chatter and reduces component wear and corrosion.

- » 1 L • 502563
- » 25 L • 502564
- » 200 L • 502565



ANTI-FREEZE

Prevent corrosion on metal components, eliminate scaling and maximize cooling system performance.

- » 1 L • 502566
- » 25 L • 502567
- » 206 L • 502568



CARBON CLEAN

Ultimate fuel and injection system cleaner.

- » 125 ML • 502528



FUEL STABILIZER

Fuel Stabilizer prevents ethanol corrosion and stabilizes fuel for up to 2 years. Dual-antioxidant formula protects against gum and varnish for easy starting.

- » 125 ML • 502519
- » 355 ML • 2882519

JUMP STARTERS



**NOCO BOOST® GB40 12V
1000A JUMP STARTER**

- Delivers 1,000 amps for jump starting a dead battery in seconds
- » 2830547



**NOCO BOOST® GB70 12V
2000A JUMP STARTER**

- Delivers 2,000 amps for jump starting a dead battery in seconds
- » 2830597



**NOCO BOOST® JUMP PACK
PROTECTION CASES**

- Lightweight, durable and rugged custom exterior
- » GB40 • 2830548
- » GB70 • 2830598

YOUR BATTERY
IS READY
WHEN YOU ARE

SERVICE PARTS



POLARIS ENGINEERED SERVICE PARTS DELIVER UNMATCHED PERFORMANCE AND FIT FOR YOUR OFF-ROAD VEHICLE.

All service parts are engineered specifically for your machine. Which means everything is designed, tested and perfected to maximize the life of your ride. Getting Polaris Engineered parts is a decision that pays off in the long run, because there is a long run.

VISIT YOUR POLARIS DEALER TO SHOP FOR SERVICE PARTS.

FOR THE LIFE OF YOUR RIDE

Maintenance is the key to keeping your Polaris off-road vehicle performing at its peak. Items like belts, lubricants, and batteries represent only a few of these critical items engineered specifically by Polaris.



TESTED, PERFECTED

We test each belt on the intended vehicle - we don't just try to make an existing belt "just work" - Amery, Polaris System Engineer

POLARIS ENGINEERED DRIVE BELTS

OUR INVESTMENT

- 32,187 km of field testing
- Thousands of dyno hours
- 18+ months of development (3,000+ design hours) per belt
- 1,200+ vehicle validation hours
- Collaboration with powertrain & clutch engineers

YOUR ADVANTAGE

- No clutch recalibration
- Less wear & tear due to heat
- Ensure maximum performance of your vehicle
- More time out riding, less time wrenching

OUR INVESTMENTS ENSURE POLARIS BELTS OUTPERFORM YOUR EXPECTATIONS.



APPAREL

FIT FOR ANY ADVENTURE. For outdoor enthusiasts looking for gear that's purposefully built to stand up to the fun and challenging experiences Polaris vehicles enable. Each piece of apparel and equipment bearing the name Polaris is crafted by outdoor enthusiasts, for outdoor enthusiasts. They are a badge of honor - representing what the Polaris brand stands for - a passion to simply be outside doing what you love.

RANGER APPAREL & MERCHANDISE



MEN'S RANGER TEE

S-3XL
Green | 2833091
Black | 2833092



MEN'S LONG SLEEVE RANGER TEE

S-3XL
Black | 2833094
Gray | 2833093



NEW RANGER HOODIE

S-3XL
Black | 2865589



POLARIS RANGER STICKER 6"

15.24 cm x 2.16 cm | 2861864



POLARIS RANGER PARKING SIGN

2869933



RANGER CAP

Black | 2833131
Green | 2833132



RANGE COLLECTION



NEW RANGE WORK JACKET

Rugged and warm jacket that's tough for work and comfortable for play

MEN'S | S-3XL
Black | 2865321
Tan | 2865322

WOMEN'S | S-3XL
Black | 2865345
Tan | 2865346

APPAREL

RANGER APPAREL & MERCHANDISE

RANGE COLLECTION

RACING COLLECTION

CASUALWEAR & HATS

HOME & COLLECTIBLES

HELMETS & GOGGLES

RACING COLLECTION



HELMET

- Polycarbonate shell
- Removable & washable lining
- Double lens system with integrated sun visor
- Quick release micrometric adjustment system

Black Matte | XS-2XL | 2802408
 White Gloss | XS-2XL | 2802311
 Dark Gray Matte | XS-2XL | 2802312



- Weight: 1450 g (+/-50 g)
- 1 shell and 2 EPS: XS-M, L-XXL
- ECE 22-06 approved



BOOTS

- Waterproof and breathable lining
- Full-grain oil treated leather upper
- Specific ATV double density compound rubber sole
- Adjustable Velcro® closure
- Replaceable/adjustable plastic buckles
- Anti-bacterial replaceable footbed
- CE-approved motorcycle boots EN 13634:2017

Black | EU39 - 47 | 2802313
 Brown | EU39 - 47 | 2802314



SPORT JACKET

- Light and water repellent jacket
- Ideal for ATV and SxS ride in wet weather
- 2 zipped pockets on the outside and 2 inside pockets
- Laser cut under the arms for better ventilation

Black | XS-4XL | 2802409



SPORT PANTS

- Light and water repellent pant
- Ideal for ATV and SxS in wet weather
- Ergonomic cut and stretch to gain comfort
- 1 zipped pocket
- Belt adjustment with micrometric buckle

Black | XS-4XL | 2802410



TECHNICAL SHIRT

- 100% polyester
- Indelible sublimated graphics
- Hemmed edging
- Lycra cuffs and collar

Men's | Black | S-3XL | 2802404
 Women's | White | S-2XL | 2802405



SAFETY GLOVES TOUCH



- CE-approved motorcycle glove EN 13594:2015
- Touch screen compatible
- Silicon print on fingers to improve grip
- Neoprene cuff with Velcro® tightening
- Reinforcements patches for safety and comfort

Khaki | S-3XL | 2802309
 Black | XS-7, 3XL-13 | 2802103



NEO GLOVES



- CE-approved motorcycle glove EN 13594:2015
- 100% synthetic neoprene glove
- Touch screen compatible
- Knuckle protected
- Reinforcements patches for safety and comfort

Black | XS-7, 3XL-13 | 2802310



SF TECH GLOVES TOUCH



- CE-approved motorcycle glove EN 13594:2015
- Touch screen compatible
- Knuckle-protected
- Silicon print on fingers to improve grip
- Neoprene cuff with Velcro® tightening
- Reinforcements patches for safety and comfort

Khaki | S-3XL | 2802308
 Black | XS-7, 3XL-13 | 2802102



NEW
HYBRID HOODIE

- Sporty sweatshirt with padded front
- 80g quilted front
- Hood and sleeves in interlock knit

Black | S-3XL | 2800325



NEW
PACKABLE PUFFER JACKET

- Lightweight packable padded down jacket
- Suitable for mid-season or as a mid-layer
- Packable in a practical pouch provided
- Can be easily stored in your vehicle
- Main material 100% polyamide
- Insulation 100% polyester

Dark Blue | S-3XL | 2800125



WATERPROOF JACKET

- 100% polyester 2.5 Layer stretch fabrics
- PU membrane waterproof and breathable 3000 mm / 3000 gr
- All seams taped and WR main zipper
- Adjustable hood
- Ventilation system on back to improve ventilation

Black | S-3XL | 2802403



NEW
PUFFY JACKET 2.0

- Top body and shoulder polyester woven 3000 mm/3000 gr + welded quilting
- Lower body nylon 380T downproof
- 80gr padding
- Inner elastic bottom tightening
- Two external pockets with easy-grab puller

Black | S-3XL | 2800725



PADDED JACKET

- Shoulder and hood softshell waterproof and breathable 3000 mm/3000 gr
- Lower body and sleeve, polyester woven waterproof and breathable 3000 mm/3000 gr
- Quilted lining with 80 gr padding
- Elasticized lower body tightening
- Two external pockets with easy-grab puller

Black | S-3XL | 2802306



NEW
PADDOCK RAINCOAT

- Waterproof rain coat made of polyester fabrics with PVC coating on outside
- All seam are high frequency welded
- Raglan sleeve shape
- Two front patch pocket with flaps
- Front opening with snaps

Black | M/L, XL/XXL | 2800425



BODYWARMER

- Upper body and side panels in softshell waterproof and breathable 3000 mm/3000 g
- Lower body nylon downproof
- Padding 80 g
- Two external pockets with easy-grab puller

Khaki | S-3XL | 2802304
Black | S-3XL | 2802101



RACING SOFTSHELL

- Softshell waterproof and breathable 3000 mm/3000 g
- Removable hood
- Four external pockets with easy-grab puller

Women's | Black | S-XL | 2802402
Men's | Khaki | S-3XL | 2802305
Men's | Black | S-3XL | 2802003



HYBRID JACKET

- Sleeves in softshell waterproof and breathable 3000 mm/3000 g
- Body nylon downproof
- Padding 80 g
- Three external pockets with easy-grab puller

Khaki | S-3XL | 2802401
Black | S-3XL | 2802004

CASUALWEAR & HATS



NEW
SOFTSHELL JACKET 2.0

MEN'S S-3XL	WOMEN'S S-3XL
Black 2865318	Black 2865343
Rust 2865319	Blue 2865344
Blue 2865320	

PURSUIT HOODIE

MEN'S S-3XL	WOMEN'S S-3XL
Orange 2864606	NEW Camo 2865488
Camo 2862494	
Black 2833076	
Green 2833077	

NEW
TECH FULL-ZIP HOODIE

MEN'S S-3XL	WOMEN'S S-3XL
Black 2865507	Black 2865509
Olive 2865508	Teal 2865510



PLAID FLANNEL SHIRT

MEN'S S-3XL	WOMEN'S S-3XL
NEW Cabernet 2865495	NEW Cabernet 2865496
Blue 2864671	Blue 2864673
Cypress 2864672	Teal 2864674



NEW
PERFORMANCE SHIRT

MEN'S S-3XL
Sand 2865497
Cypress 2865498



PIT SHIRT **TOP SELLER**

MEN'S SIZE VARIES
Cypress S-3XL 2864561
Black XS-4XL 2862526
Navy S-3XL 2833043



STAPLE CAP **TOP SELLER**

NEW Maroon 2865516
Cypress 2864568
Black 2833127
Navy 2833128



CORE CAP **TOP SELLER**

Red 2833123
Gray 2833507
Navy 2833494
Black 2833495



SHIELD PATCH CAP

Navy 2864578
Red 2864579



TONAL HAT

Orange 2864564
Black/Red 2833497
Navy 2833496



STEALTH CAMO CAP

Camo | 2861527



HUNTER ORANGE HAT

S/M 2860892
L/XL 2862545



CAMO BEANIE (REVERSIBLE)

Camo | 2833118



CORE BEANIE

Orange | 2862595

HOME & COLLECTIBLES



POLARIS KEY RACK
30.5 cm x 20 cm | 2864718



POLARIS LED SIGN
61 cm x 26.7 cm | 2862736



POLARIS RACING LED SIGN
61 cm x 22.9 cm | 2862737



ALUMINUM SIGN
55.9 cm | 2860867



WOOD SIGN
61 cm x 26.7 cm | 2860866



POLARIS STEEL SIGN
91.4 cm x 35.6 cm | 2860868



POLARIS PARKING SIGN
2869934



POLARIS FLAG
152 cm x 91.4 cm | 2869928



DECK OF CARDS
2860816



POLARIS PVC COASTERS
2864715



POLARIS NOTEBOOK
2860831



LEATHER KEY CHAINS
Leather Loop | 2861615
Black Leather | 2861616



PADDOCK UMBRELLA
2800625



HITCH COVER
2861623



LICENSE PLATE HOLDER
2862687



POLARIS RANGER PARKING SIGN
2869933

APPAREL

RANGER APPAREL & MERCHANDISE

RANGE COLLECTION

RACING COLLECTION

CASUALWEAR & PARTS

HOME & COLLECTIBLES

HELMETS & GOGGLES

HELMETS



CARBON FIBER BLACK
S-2XL | 2833158



DELTA V COMMANDER

NO LONGER A HELMET, IT'S A COCKPIT

S-2XL

SHELL

- Carbon fiber
- Lightweight polycarbonate

WEIGHT

- Up to 1,832 g

FEATURES

- The Delta V Commander features an integrated communication system, infinity style sealed IGNITE heated shield, and ergonomic design
- Features in-helmet JBL® speakers for audio and an integrated microphone to connect up to 14 users in a group with the best sound and noise cancellation for all your rides
- Venturi Vent Ducting, an integrated spoiler, and low-profile antennae keeps this helmet sleek, quiet, and fog-free all day on the trails
- 12-volt power input on left side powers shield, comms, and chase light with controls for bright, normal, and off positions
- Battery power for up to 10 hours of riding
- Connect via Bluetooth™ to your music, phone, maps, and sled
- DOT/ECE 22.06 dual certified helmet shell and luxurious liner
- Fidlock® chinstrap for easy on and off



BLACK
2833151



WHITE
2833150



TEAL/LIME
2865411



NEW

TACTICAL 3.0 MTN

EXPERIENCE TOP-TIER PROTECTION, COMFORT, AND CONNECTIVITY IN THE MOUNTAINS

XS-4XL

SHELL

- Poly and ABS Polymer Construction - ensures both strength and a lightweight feel for maximum protection

WEIGHT

- Starting at 1,300g

FEATURES

- Venturi Vent system generates negative pressure at velocity and pulls moist air from the breath box
- Cardo® UCS Compatibility - integration and easy assembly of Cardo® UCS modules (sold separately)
- Magnetic Fidlock® chin-strap technology
- Plush liner design
- Compatible with VEES Protection System (sold separately) for cold days
- DOT-and ECE 22.06-approved



BLUE
2865412

RETRO
2865409

BLACK
2865408

V.E.E.S. LINER
2865412

GOGGLES



94

POLARIS



NEW
FUCHSIA/GRAY
2865427

509 KINGPIN



FEATURES

- Built for off-road, the oversized spherical lens delivers optimal peripheral vision
- Metal tear-off posts provide strength and durability
- Quick-change technology allows you to run the best lens tint for conditions



OLIVE/LIME
2864546

STEALTH
2862560

NEW
BLUE/WHITE
2865428



NEW
MAROON/FUCHSIA
2865435

TENACITY 4.0

COMBINATION OF MODERN STYLE & PREMIUM PROTECTION WITH INCREDIBLE VALUE

XS-2XL

SHELL

- Shock-resistant, injection-molded thermoplastic

WEIGHT

- 1,500g

FEATURES

- Through-flow, full-helmet ventilation
- ProClip quick release chin strap allows you to fasten the chin strap in seconds
- Removable breath box and removable, washable liner
- Tool-less adjustable roost shield
- DOT/ECE 22.06 dual certified helmet shell



BLACK
2865418

FOR
POLARIS FIDLOCK.

NEW

YOUTH TACTICAL 3.0

EMPOWER THE NEXT GENERATION OF RIDERS WITH CUTTING EDGE TECH

S-L

SHELL

- Poly and ABS Polymer construction ensures both strength and a lightweight feel for maximum protection

FEATURES

- Venturi Vent system generates negative pressure at velocity and pulls moist air from the breath box
- Cardo® UCS Compatibility - integration and easy assembly of Cardo® UCS modules (sold separately)
- Plush liner design
- Magnetic Fidlock® chin-strap technology to enable faster securing and removing of the helmet
- DOT-and ECE 22.06-approved



NEW
GRAY/BLUE
2865434



BLACK/LIME
2864560



BLACK
2864859



TEAL/LIME
2865420



NEW
TEAL/LIME
2865430

509 MX6



FEATURES

- PC outer lens with anti-scratch coating, and internal anti-fog coating
- Outriggers with latch system for quick lens change
- 45mm strap with silicone to hold strap in place



NEW
TEAL/LIME
2865429

YOUTH RIPPER



FEATURES

- Excellent visibility
- Anti-fog performance
- Scratch resistant durability



ORANGE
2864545

BLACK
2862557

NEW
BLUE
2865431



CRUISER BLACK
2864549

HARDEST WORKING. SMOOTHEST RIDING.



POLARIS
Think Outside

Availability varies by market, check your local dealer for availability. Image taken on private land. The use of vehicles in similar environments in your jurisdiction may be prohibited per locally applicable laws and regulations. Campfire in similar environments in your jurisdiction may be prohibited per locally applicable laws and regulations. Keep your campfire safe, and make sure you can control it at all times. Know your locally applicable laws and regulations. Crossing water in similar environments may be prohibited in your jurisdiction.

Warning: Polaris Off Road vehicles can be hazardous to operate and are not designed for on-road use. Driver must be at least 16 years old with a valid driver's license to operate. All riders should always wear helmets, eye protection and footwear. Read, understand and follow your owner's manual. Ride within the limits of your own abilities and never engage in stunt or exhibition driving. Never ride under the influence of drugs or alcohol. All riders should take a safety training course.

Unless noted, trademarks are the property of Polaris Industries Inc. 509® is a registered trademark of Teton Outfitters, LLC. Apple® and App Store® are registered trademarks of Apple Inc. Bluetooth® is a registered trademark of Bluetooth Sig, Inc. Caliber® is a trademark of Caliber, Inc. Cardo® is a registered trademark of Cardo Systems, Inc. Carhartt® is a registered trademark of Carhartt, Inc. CruzTOOLS® is a registered trademark of CYCOACTIVE, INC. Facebook™ is a service trademark of Facebook, Inc. Fidlock® is a registered trademark of Fidlock GmbH. FOX® is a registered trademark of Fox Factory Inc. Google Play™ is a service trademark of Google LLC. YouTube® is a registered trademark of Google LLC. GoPro® is a registered trademark of GoPro Inc. Homelink® is a registered trademark of Gentex Corporation. Instagram™ is a service trademark of Instagram, LLC. JBL® is a registered trademark of Harman International Industries, Incorporated. MB Quart® is a registered trademark of Maxxsonics USA Inc. NDRFLEX® is a registered trademark of FNA Group, Inc. NOCO Boost® and NOCO Genius® are registered trademarks of The Noco Company. RHINO-RACK® is a registered trademark of Rhino Rack Australia Pty Limited. RIGID® is a trademark of JUST Performance, LLC d/b/a Rigid Industries LLC. SEAT SAVER® is a registered trademark of Prince Lionheart, Inc. SMART BOARD® is a registered trademark of Smart Technologies ULC Unlimited Liability Corporation Canada. Tiger Drylac® is a registered trademark of Tiger Coatings GmbH & CO. KG. Twitter™ is a service trademark of X CORP. Wallbox™ is a service trademark of WALL BOX CHARGERS S.L. Fitment and availability are subject to change at any moment. Copyright © 2024 Polaris Industries Inc. All rights reserved.

MY25 RGR APP ACC - EMEA