

POLARIS RZR



2025

**ACCESSORIES,
MAINTENANCE & APPAREL**

EMEA VERSION



#RZRLife

LIVE THE LIFESTYLE.
JOIN THE COMMUNITY.

POLARIS



POLARIS RZR

08 RZR PRO R, PRO S & PRO XP

- 14 AUDIO
- 16 WINDSHIELDS & REAR PANELS
- 18 ROOFS, DOORS & CAB ACCESSORIES
- 20 VEHICLE PROTECTION
- 22 LIGHTING
- 24 STORAGE
- 26 HARNESES, MIRRORS, MISC & WINCHES

30 RZR XP

- 34 AUDIO
- 36 WINDSHIELDS & REAR PANELS
- 38 ROOFS, DOORS & HEATER
- 40 VEHICLE PROTECTION
- 42 LIGHTING
- 44 STORAGE
- 46 MIRRORS, HARNESES & WINCHES

50 RZR TRAIL S

- 52 WINDSHIELDS & REAR PANELS
- 54 ROOFS, DOORS & AUDIO
- 56 VEHICLE PROTECTION & STORAGE
- 58 WINCHES, HEATER & PLOWS
- 60 LIGHTING & ELECTRICAL
- 61 HARNESES, MIRRORS & TRACKS

64 YOUTH

66 COMMON ACCESSORIES

- 66 WINCHES
- 68 LIGHTING
- 70 CONNECTED TECHNOLOGY
- 72 COOLERS
- 74 PRO ARMOR WHEELS & TIRES
- 82 CLEANERS & TRAILERING

84 MAINTENANCE & GARAGE

- 84 OIL & LUBRICANTS
- 86 JUMP STARTERS & SERVICE PARTS

88 APPAREL

- 89 RZR APPAREL & MERCH
- 90 JERSEYS, GLOVES & GAITERS
- 91 HOME & COLLECTIBLES
- 92 RACING COLLECTION
- 94 HELMETS & GOGGLES

IMPORTANT: Adding accessories may impact the vehicle's conformity to its homologation or type approval. Polaris recommends consulting with local authorities and/or your local dealer to understand the requirements and restrictions related to the installation of accessories on your vehicle.



DESIGNED
by the people who designed your vehicle.

TESTED
in the field so you ride with 100% confidence.

TRUSTED
70 years in the business. The #1 name in off-road.

KEEP YOUR STANDARDS HIGH. WE DO.



WE HOLD OUR PARTNERS TO THE SAME STANDARDS

Sharing an outdoor adventure with a companion or two gives your experience its very own energy. When we meet another brand that builds and tests their products with the same rigor as we do, a kinship forms. So we give them an exclusive partner badge and invite them along for the ride. It's another way we bring you the best options for customizing your Polaris vehicle without compromise. How better to send you and your crew out into the world?



PURPOSE-BUILT ACCESSORIES FOR YOUR RZR





> **ENDLESS CUSTOMIZATION**

A complete accessory lineup developed to fit the needs of every riding style.



> **UNMATCHED ENGINEERING**

Relentless attention to detail delivers extraordinary quality and personalized comfort.



> **SUPERIOR INNOVATION**

Seamlessly integrated technology offerings that take your ride to the next level.

RZR PRO R

POLARIS
RZR PRO R





> **DUNE PACKAGE**

- | | | | |
|-------------|--|---------|--|
| 3880099 | Stage 6 Audio Kit (Ultimate) by Rockford Fosgate*: P. 15 | 2890052 | Chase Light Harness Kit: P. 22 |
| 2884237-458 | Aluminum Roof, 2-Seat*: P. 18 | 2884236 | LR 34 L Rear Cargo Box: P. 24 |
| 2891017 | GatorStep® Premium Roof Liner, 2-Seat: P. 19 | 2883424 | Polaris NorthStar 28 L Cooler: P. 25 |
| 2891019 | GatorStep® Front Armrest Pads: P. 19 | 2889200 | LR NorthStar 28 L Cooler Bracket: P. 25 |
| 2890391-887 | Front Low Profile Bumper: P. 20 | 2889785 | 9.5 L Door Storage Bag: P. 25 |
| 2891093-887 | Pro Armor Aluminum Front Grille: P. 21 | 2883763 | Premium Convex Rearview Mirror: P. 26 |
| 2884648 | RIGID® SR-Series 81.3 cm Combo LED Light Bar: P. 22 | 2891232 | Pro Armor Side Mirrors: P. 26 |
| 2884601 | 81.3 cm Light Bar Mount: P. 22 | 2889795 | Pro Armor 5x5cm Cube LED Spot Lights (2): P. 69 |
| 2889130 | Polaris PULSE HD Light Bar Harness (x2): P. 22 | 2879860 | LED Y-Harness: P. 69 |
| 2884359 | RIGID® Chase Light: P. 22 | 2885020 | Pro Armor Wheel & Tire Set:
5207/5303 & Sand 16XT, 32": P. 81 |
| 2884896 | Chase Light Mount Kit: P. 22 | | |



› DESERT PACKAGE

2884325-458	Aluminum Roof, 4-Seat*: P. 18	2889785	9.5 L Shoulder Storage Bag: P. 25
2890391-293	Front Low Profile Bumper: P. 20	2890387	7.5 L Front Door Storage Bags: P. 25
2884648	RIGID® SR-Series 81.3 cm Combo LED Light Bar: P. 22	2890516	7.5 L Rear Door Storage Bags: P. 25
2884601	81.3 cm Light Bar Mount: P. 22	2890863-458	Pivoting Spare Tire Carrier: P. 25
2889130	Polaris PULSE HD Light Bar Harness: P. 22	2883763	Premium Convex Rearview Mirror: P. 26
2884359	RIGID® Chase Light: P. 22	5417174	Pro Armor Spare Tire: Crawler XR, 33": P. 76
2884896	Chase Light Mount Kit: P. 22	1524038	Pro Armor Spare Wheel: 5307 Beadlock, 15": P. 78
2890052	Chase Light Harness Kit: P. 22	2890983	Pro Armor Wheel & Tire Set: 5307 Beadlock & Crawler XR, 33": P. 81
2884235	 57 L Forward Cargo Box: P. 24		
2889740	 28 L Rear Cooler: P. 25		

Shown on Pro R Ultimate 4-Seat. Applicable to all models with adjustments.
*Stock on Ultimate trim

RZR PRO S

POLARIS
RZR PRO S



> DESERT PACKAGE

- | | | | |
|-------------|---|-------------|---|
| 2890374 | LR Half Windshield - Hard Coat Poly: P. 17 | 2883752 | LR 40 L Rear Cargo Box: P. 24 |
| 2883928 | Poly Sport Roof, 2-Seat*: P. 18 | 2883424 | Polaris NorthStar 28 L Cooler: P. 25 |
| 2890391-293 | Front Low Profile Bumper: P. 20 | 2884070 | LR NorthStar 28 L Cooler Bracket: P. 25 |
| 2884648 | RIGID® SR-Series 81.3 cm Combo LED Light Bar: P. 22 | 2890387 | 7.5 L Front Door Storage Bags: P. 25 |
| 2884650 | 81.3 cm Light Bar Mount: P. 22 | 2889404-458 | Pivoting Spare Tire Carrier: P. 25 |
| 2889130 | Polaris PULSE HD Light Bar Harness: P. 22 | 2883763 | Premium Convex Rearview Mirror: P. 26 |
| 2884359 | RIGID® Chase Light: P. 22 | 5417533 | Pro Armor Spare Tire: Pro Runner, 33": P. 76 |
| 2884896 | Chase Light Mount Kit: P. 22 | 1525686-458 | Pro Armor Spare Wheel: 5307 Beadlock, 15": P. 78 |
| 2890052 | Chase Light Harness Kit: P. 22 | 2890975 | Pro Armor Wheel & Tire Set:
5307 Beadlock & Pro Runner, 33": P. 81 |







➤ ROCK PACKAGE

- | | | | |
|-------------|---|---------|---|
| 2890430-458 | Aluminum Roof, 2-Seat: P. 18 | 2883763 | Premium Convex Rearview Mirror: P. 26 |
| 2890390-458 | Front High Coverage Bumper: P. 20 | 2891232 | Pro Armor Side Mirrors: P. 26 |
| 2884189-458 | Rear High Coverage Bumper: P. 20 | 2890402 | Polaris Pro HD 2,041 kg Winch: P. 27 |
| 2890394-458 | Low Profile Rock Sliders, 2-Seat: P. 21 | 2889791 | Pro Armor 83.8 cm Combo LED Light Bar: P. 69 |
| 2889130 | Polaris PULSE HD Light Bar Harness: P. 22 | 2890053 | Light Bar Mount: P. 69 |
| 2884684 | Pro Armor Rock Lights, Blue: P. 23 | 2890978 | Pro Armor Wheel & Tire Set:
5307 Beadlock & Crawler XG, 33": P. 81 |
| 2883751 |  69 L Forward Cargo Box: P. 24 | | |
| 2889740 |  28 L Rear Cooler: P. 25 | | |

Shown on Pro S Premium 2-Seat. Applicable to all models with adjustments.



➤ RUGGED TRAIL PACKAGE

- | | | | |
|-------------|--|-------------|---|
| 2889709 | Audio Roof by Rockford Fosgate®, 4-Seat: P. 14 | 2889785 | 9.5 L Shoulder Storage Bag: P. 25 |
| 2890375 |  Full Vented Windshield - Hard Coat Poly: P. 17 | 2889404-458 | Pivoting Spare Tire Carrier: P. 25 |
| 2890384 |  Rear Panel - Hard Coat Poly, 4-Seat: P. 17 | 2883763 | Premium Convex Rearview Mirror: P. 26 |
| 2891019 | GatorStep® Front Armrest Pads: P. 19 | 2891232 | Pro Armor Side Mirrors: P. 26 |
| 2891113 | GatorStep® Rear Armrest Pads: P. 19 | 2890572 | Secondary Battery Mount Kit: P. 26 |
| 2890390-458 | Front High Coverage Bumper: P. 20 | 2890403 | Polaris Pro HD 2,721 kg Winch: P. 27 |
| 2884189-458 | Rear High Coverage Bumper: P. 20 | 4014609 | Polaris Engineered Battery: P. 28 |
| 2890407 | Full Coverage Fender Flares: P. 21 | 5418110 | Pro Armor Spare Tire: Crawler XP, 32": P. 76 |
| 2890397-458 | HD Extreme Kick-Out Rock Sliders, 4-Seat: P. 21 | 1525420 | Pro Armor Spare Wheel: 5304 Beadlock, 15": P. 76 |
| 2883751 |  70 L Forward Cargo Box: P. 24 | 2889997 | Pro Armor Wheel & Tire Set:
5304 Beadlock & Crawler XP, 32": P. 81 |
| 2883752 |  40 L Rear Cargo Box: P. 24 | | |

Shown on Pro S Ultimate 4-Seat. Applicable to all models with adjustments.

PRO R, PRO S & PRO XP

AUDIO

WINDSHIELDS
& REAR PANELS

ROOF, DOORS
& CAB ACCESSORIES

VEHICLE PROTECTION

LIGHTING

STORAGE

HARNESSES, MIRRORS,
MISC & WINCHES

MAINTENANCE PARTS
& FLUIDS

RZR PRO XP

POLARIS
RZR PRO XP

➤ TRAIL PACKAGE

2890375	 Full Vented Windshield - Hard Coat Poly: P. 17	2883751	 70 L Forward Cargo Box: P. 24
2891091	 Rear Panel - Hard Coat Poly, 2-Seat: P. 17	2883752	 40 L Rear Cargo Box: P. 24
2890430-458	Aluminum Roof, 2-Seat: P. 18	2889785	9.5 L Shoulder Storage Bag: P. 25
2890388-458	Front High Coverage Bumper: P. 20	2889404-458	Pivoting Spare Tire Carrier: P. 25
2884189-458	Rear High Coverage Bumper: P. 20	2883763	Premium Convex Rearview Mirror: P. 26
2890396-458	HD Extreme Kick-Out Rock Sliders, 2-Seat: P. 21	2891232	Pro Armor Side Mirrors: P. 26
2884648	RIGID® SR-Series 81.3 cm Combo LED Light Bar: P. 22	2890398	Polaris Pro HD 2,041 kg Winch: P. 27
2884650	81.3 cm Light Bar Mount: P. 22	5418676	Pro Armor Spare Tire: Trekker, 30": P. 76
2889130	Polaris PULSE HD Light Bar Harness: P. 22	1525455	Pro Armor Spare Wheel: 5305 Beadlock, 15": P. 78
2884684	Pro Armor Rock Lights, Blue: P. 23	2890912	Pro Armor Wheel & Tire Set: 5305 Beadlock & Trekker, 30": P. 80



> BACKCOUNTRY PACKAGE

- | | | | |
|-------------|---|-------------|---|
| 2889710 | Audio Roof by Rockford Fosgate®, 2-Seat: P. 14 | 2890387 | 7.5 L Front Door Storage Bags: P. 25 |
| 2890374 | LR Half Windshield - Hard Coat Poly: P. 17 | 2889404-458 | Pivoting Spare Tire Carrier: P. 25 |
| 2890389-293 | Front Low Profile Bumper: P. 20 | 2883763 | Premium Convex Rearview Mirror: P. 26 |
| 2890396-293 | HD Extreme Kick-Out Rock Sliders, 2-Seat: P. 21 | 2884347 | Secondary Battery Mount Kit: P. 26 |
| 2884359 | RIGID® Chase Light: P. 22 | 2890398 | Polaris Pro HD 2,041 kg Winch: P. 27 |
| 2884896 | Chase Light Mount Kit: P. 22 | 4014609 | Polaris Engineered Battery: P. 28 |
| 2890052 | Chase Light Harness Kit: P. 22 | 5417531 | Pro Armor Spare Tire: Pro Runner, 30": P. 76 |
| 2883752 | LR 40 L Rear Cargo Box: P. 24 | 1525454 | Pro Armor Spare Wheel: 5208, 15": P. 78 |
| 2883424 | Polaris NorthStar 28 L Cooler: P. 25 | 2890176 | Pro Armor Wheel & Tire Set: 5208 & Pro Runner, 30": P. 81 |
| 2884070 | LR NorthStar 28 L Cooler Bracket: P. 25 | 2890429 | Off-Road Tool Roll by CruzTOOLS®: P. 82 |

Shown on Pro XP Sport 2-Seat. Applicable to all models with adjustments.



> ALL-SEASON PACKAGE

- | | | | |
|-------------|--|---------|--|
| 2890378 | Full Windshield - Glass: P. 17 | 2883751 | LR 70 L Forward Cargo Box: P. 24 |
| 2890381 | Glass Windshield Wiper Kit: P. 17 | 2889740 | LR 28 L Rear Cooler: P. 25 |
| 2890384 | LR Rear Panel - Hard Coat Poly, 4-Seat: P. 17 | 2889785 | 9.5 L Shoulder Storage Bag: P. 25 |
| 2883946 | Poly Sport Roof, 4-Seat*: P. 18 | 2890387 | 7.5 L Front Door Storage Bags: P. 25 |
| 2890409 | Upper Doors, 4-Seat: P. 19 | 2890516 | 7.5 L Rear Door Storage Bags: P. 25 |
| 2890418 | Heater Kit: P. 19 | 2883763 | Premium Convex Rearview Mirror: P. 26 |
| 2890388-293 | Front High Coverage Bumper: P. 20 | 2890399 | Polaris Pro HD 2,721 kg Winch: P. 27 |
| 2884189-293 | Rear High Coverage Bumper: P. 20 | 2889954 | Pro Armor Wheel & Tire Set: 5301 Beadlock & Crawler XP, 30": P. 81 |
| 2890407 | Full Coverage Fender Flares: P. 21 | | |
| 2890397-293 | HD Extreme Kick-Out Rock Sliders, 4-Seat: P. 21 | | |

Shown on Pro XP Ultimate 4-Seat. Applicable to all models with adjustments.
*Stock on Ultimate trim

PRO R, PRO S & PRO XP

AUDIO

WINDSHIELDS & REAR PANELS

ROOF, DOORS & CAB ACCESSORIES

VEHICLE PROTECTION

LIGHTING

STORAGE

HARNESSES, MIRRORS, MISC & WINCHES

MAINTENANCE PARTS & FLUIDS

RZR PRO R, PRO S & PRO XP



> AUDIO



Rockford Fosgate partnered with Polaris to create the next evolution of factory-installed off-road audio. Purpose-built to stand up to any outdoor environment and designed to perform no matter the ride. Specifically tuned and rider-centric to create an audio experience that is second to none.

- PLUG & PLAY
- ELEMENT READY
- NO LOSS OF CARGO SPACE
- BLUETOOTH

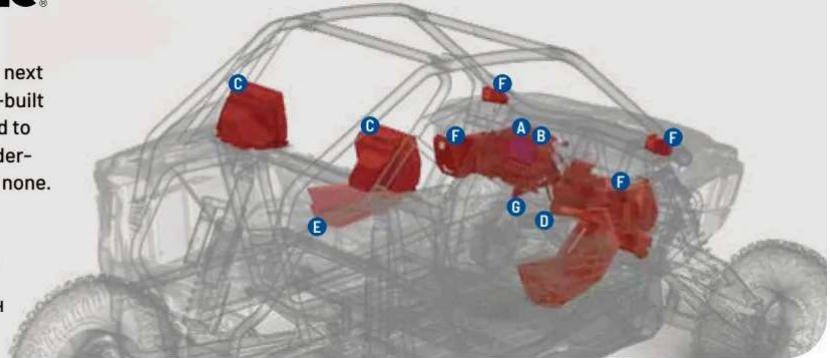

BUILD YOUR AUDIO



A. 7" DISPLAY POWERED BY RIDE COMMAND

- » 2884072
PRO S/4 '25, PRO XP/4 '20-25, TURBO R/4 '22-24
STANDARD ON PREMIUM/ULTIMATE MODELS
Requires Mount Kit (2884584/2890417)
- » 2890898
PRO R/4 '22-25
STANDARD ON ULTIMATE MODELS
Requires Mount Kit (2890417)

SEE P. 70 FOR RIDE COMMAND DETAILS



B. PMX-P2 HEAD UNIT

- 6.86 cm full color display
- AM/FM/WB tuner** with Bluetooth connectivity
- » 2890410
PRO R/4 '25, PRO S/4 '25, PRO XP/4 '25
NOT COMPATIBLE WITH PREMIUM/ULTIMATE MODELS



C. REAR SPEAKERS

- 50 watt 16.51 cm component speakers and enclosures
- » 2890411
PRO R/4 '25, PRO S/4 '25, PRO XP/4 '25



D. SUBWOOFER

- Subwoofer with enclosure and grille
- 400 watt integrated subwoofer amplifier
- » 25.4 CM • 2890413*
PRO R/4 '25, PRO S/4 '25, PRO XP/4 '25
- » 30 CM • 2890414
PRO R/4 '25, PRO S/4 '25, PRO XP/4 '25



400W AMPLIFIER

- 400 watt full range amplifier
- » 2890412
PRO R/4 '25, PRO S/4 '25, PRO XP/4 '25



REAR PODS

- 50 watt 16.51 cm coaxial speakers with can-enclosures, mounting hardware and grilles
- » 2883945
PRO R/4 '22-25, PRO S/4 '25, PRO XP/4 '20-25, TURBO R/4 '22-24
Stage 5 & 6 Audio Kit compatibility for MY25+ only



E. FRONT DOOR SPEAKERS

- 50 watt coaxial speakers with door enclosures
- Integrated door handle on enclosure
- » 2890518
PRO R/4 '25, PRO S/4 '25, PRO XP/4 '25



F. DASH SPEAKER KIT

- 50 watt component speakers and enclosures
- Includes independent tweeter speakers
- » 2891254
PRO R/4 '25, PRO S/4 '25, PRO XP/4 '25



G. ACTIVE BASS CONTROL KNOB

- Knob to adjust subwoofer output independently of speaker volume
- » 2890427
PRO R/4 '25, PRO S/4 '25, PRO XP/4 '25



STAINLESS STEEL GRILLES

- Stainless steel grille upgrades
- » 2891255
PRO R/4 '25, PRO S/4 '25, PRO XP/4 '25

*Fall availability **The FM Frequency range is from 88 to 108 and only on the odds (i.e. 88.1, 88.3, etc).



AUDIO ROOF

20 CM SPEAKERS, 25.4 CM SUBWOOFER, 83.8 CM PRO ARMOR LIGHT BAR

- 800 watt
- 25.4 cm subwoofer
- 83.8 cm Pro Armor Single-Row Light Bar
- RGB accent lights
- LED dome light (2-Seat: 1, 4-Seat: 2)

PMX-P2 (Head unit included)

- » 2-SEAT • 2889710
PRO S '25, PRO XP '20-25, TURBO R '22-24
- » 4-SEAT • 2889708
PRO S/4 '25, PRO XP/4 '20-25, TURBO R/4 '22-24

VEHICLE-INTEGRATED AUDIO

- » 2-SEAT • 2889711
PRO S '25, PRO XP '20-25, TURBO R '22-24
- » 4-SEAT • 2889709
PRO S/4 '25, PRO XP/4 '20-25, TURBO R/4 '22-24

Not compatible with Rear Pods (2883945) or in-vehicle audio.
Secondary Battery Kit required (2884347/2890572), sold separately.



PRO R, PRO S & PRO XP

AUDIO

WINDSHIELDS
& REAR PANELS

ROOFS, DOORS
& CAB ACCESSORIES

VEHICLE PROTECTION

LIGHTING

STORAGE

HARNESSES, MIRRORS,
MISC & WINCHES

MAINTENANCE PARTS
& FLUIDS

**PRO R, PRO S & PRO XP
SPORT**

PMX-P2 HEAD UNIT

<p>STAGE 1 AUDIO KIT</p> <ul style="list-style-type: none"> • PMX-P2 Head Unit (2890410) • Dash Speaker Kit (2891254) <p style="font-size: small;">PRO R/4 '25, PRO S/4 '25, PRO XP/4 '25</p>	<p>STAGE 2 AUDIO KIT</p> <ul style="list-style-type: none"> • PMX-P2 Head Unit (2890410) • Dash Speaker Kit (2891254) • Rear Speakers (2890411) <p style="font-size: small;">PRO R/4 '25, PRO S/4 '25, PRO XP/4 '25</p>	<p>STAGE 3 AUDIO KIT</p> <ul style="list-style-type: none"> • PMX-P2 Head Unit (2890410) • Dash Speaker Kit (2891254) • Rear Speakers (2890411) • 400W Amplifier (2890412) <p style="font-size: small;">PRO R/4 '25, PRO S/4 '25, PRO XP/4 '25</p>	<p>STAGE 4 AUDIO KIT*</p> <ul style="list-style-type: none"> • PMX-P2 Head Unit (2890410) • Dash Speaker Kit (2891254) • Rear Speakers (2890411) • 400W Amplifier (2890412) • 10" Subwoofer (2890413) <p style="font-size: small;">PRO R/4 '25, PRO S/4 '25, PRO XP/4 '25</p>
--	---	---	---

OR

7" DISPLAY POWERED BY RIDE COMMAND

<p>STAGE 3 AUDIO KIT</p> <ul style="list-style-type: none"> • 7" Display Powered by RIDE COMMAND (2884072) • 7" Display Mount Kit (2890417) • Dash Speaker Kit (2891254) • Rear Speakers (2890411) • 400W Amplifier (2890412) <p style="font-size: small;">PRO S/4 '25, PRO XP/4 '25</p>	<p>STAGE 4 AUDIO KIT*</p> <ul style="list-style-type: none"> • 7" Display Powered by RIDE COMMAND (2884072) • 7" Display Mount Kit (2890417) • Dash Speaker Kit (2891254) • Rear Speakers (2890411) • 400W Amplifier (2890412) • 10" Subwoofer (2890413) <p style="font-size: small;">PRO S/4 '25, PRO XP/4 '25</p>
--	--

**PRO S & PRO XP
PREMIUM**
(7" DISPLAY POWERED BY RIDE COMMAND COMES STANDARD)

<p>STAGE 3 AUDIO KIT</p> <ul style="list-style-type: none"> • Dash Speaker Kit (2891254) • Rear Speakers (2890411) • 400W Amplifier (2890412) <p style="font-size: small;">PRO S/4 '25, PRO XP/4 '25</p>	<p>STAGE 4 AUDIO KIT*</p> <ul style="list-style-type: none"> • Dash Speaker Kit (2891254) • Rear Speakers (2890411) • 400W Amplifier (2890412) • 10" Subwoofer (2890413) <p style="font-size: small;">PRO S/4 '25, PRO XP/4 '25</p>	<p>STAGE 5 AUDIO KIT</p> <ul style="list-style-type: none"> • Dash Speaker Kit (2891254) • Rear Speakers (2890411) • 400W Amplifier (2890412) • 12" Subwoofer (2890414) • Stainless Steel Grilles (2891255) • Active Bass Control Knob (2890427) <p style="font-size: small;">PRO S/4 '25, PRO XP/4 '25</p>	<p>STAGE 6 AUDIO KIT</p> <ul style="list-style-type: none"> • Dash Speaker Kit (2891254) • Rear Speakers (2890411) • 400W Amplifier (2890412) • 12" Subwoofer (2890414) • Stainless Steel Grilles (2891255) • Active Bass Control Knob (2890427) • Front Door Speakers (2890518) <p style="font-size: small;">PRO S/4 '25, PRO XP/4 '25</p>
--	--	--	---

**PRO R, PRO S & PRO XP
ULTIMATE**
(7" DISPLAY POWERED BY RIDE COMMAND COMES STANDARD)

<p>STAGE 5 AUDIO KIT</p> <ul style="list-style-type: none"> • 12" Subwoofer (2890414) • Stainless Steel Grilles (2891255) • Active Bass Control Knob (2890427) <p style="font-size: small;">PRO R/4 '25, PRO S/4 '25, PRO XP/4 '25</p>	<p>STAGE 6 AUDIO KIT</p> <ul style="list-style-type: none"> • 12" Subwoofer (2890414) • Stainless Steel Grilles (2891255) • Active Bass Control Knob (2890427) • Front Door Speakers (2890518) <p style="font-size: small;">PRO R/4 '25, PRO S/4 '25, PRO XP/4 '25</p>
--	---

*Fall availability

RZR PRO R, PRO S & PRO XP



> BUILD YOUR CAB

ADD COMFORT AND STYLE WITH END-TO-END PROTECTION



ADD A WINDSHIELD
Protect all riders with optical clarity.

ADD A ROOF
Shield from harsh elements while adding style.

ADD A REAR PANEL
Maintain rear visibility while reducing rear air swirl.

ADD UPPER DOORS
Keep the cab free of dust and water.

PRO S PRO XP

RECOMMENDED 2-SEAT CAB

- 2890378 • Full Windshield - Glass
- 2890381 • Glass Windshield Wiper Kit
- 2890383 • Rear Panel - Hard Coat Poly
- 2883928 • Poly Sport Roof
- 2890408 • Upper Doors

Available on 2-Seat and 4-Seat vehicles.

PRO S PRO XP

RECOMMENDED 4-SEAT CAB

- 2890375 • Full Vented Windshield - Hard Coat Poly
- 2890384 • Rear Panel - Hard Coat Poly
- 2883990-458 • Aluminum Roof
- 2890409 • Upper Doors

Available on 2-Seat and 4-Seat vehicles.



REVOLUTIONARY INSTALLATION

Lock & Ride clamps make for easy on-off and eliminate the risk of cracking.



POLARIS ENGINEERED ADVANTAGES

GASKETED SEAL

Keeps drafts and moisture out. Reduces ride chatter on full glass windshields.

WINDSHIELDS

GLASS



WIPER READY

FULL WINDSHIELD - GLASS

• Double-layer, laminated and tempered glass windshield with frit around the perimeter for more premium fit and finish

» **PRO S** **PRO XP** 2890378

PRO S/4 '25, PRO XP/4 '25

» **PRO R** 2-SEAT • 2890379 **NOT SHOWN**

PRO R '25

» **PRO R** 4-SEAT • 2890380 **NOT SHOWN**

PRO R 4 '25

HARD COAT POLY



FULL VENTED WINDSHIELD - HARD COAT POLY

• Impact-resistant, long-lasting .64 cm durable hard coated polycarbonate

• Full protection with airflow vents that quickly open for cockpit ventilation

» **PRO S** **PRO XP** 2890375

PRO S/4 '25, PRO XP/4 '25

» **PRO R** 2-SEAT • 2890376 **NOT SHOWN**

PRO R '25

» **PRO R** 4-SEAT • 2890377 **NOT SHOWN**

PRO R 4 '25

HALF WINDSHIELD - HARD COAT POLY

• Impact-resistant, long-lasting .64 cm durable hard coated polycarbonate

• Provides both protection and airflow into the cab

» 2890374

PRO R/4 '25, PRO S/4 '25, PRO XP/4 '25



GLASS WINDSHIELD WIPER KIT

• Simple to control with a multi-speed, dash-mounted switch

• Includes a washer fluid reservoir

» **PRO S** **PRO XP** 2890381

PRO S/4 '25, PRO XP/4 '25

» **PRO R** 2890382 **NOT SHOWN**

PRO R/4 '25

REAR PANEL

REAR PANEL - HARD COAT POLY

• Made from hard coat polycarbonate with a flat viewing area for improved rearward visibility

» **PRO S** **PRO XP** 2-SEAT • 2890383

PRO S '25, PRO XP '25

Compatible with Rear Speakers (2890411), sold separately or standard on Ultimate trim

» **PRO S** **PRO XP** 2-SEAT • 2891091 **NOT SHOWN**

PRO S '25, PRO XP '25

Not compatible with Rear Speakers (2890411), sold separately or standard on Ultimate trim

» **PRO R** 2-SEAT • 2890385 **NOT SHOWN**

PRO R '25



» **PRO S** **PRO XP** 4-SEAT • 2890384 **NOT SHOWN**

PRO S 4 '25, PRO XP 4 '25

Compatible with Rear Speakers (2890411), sold separately or standard on Ultimate trim

» **PRO S** **PRO XP** 4-SEAT • 2891092 **NOT SHOWN**

PRO S 4 '25, PRO XP 4 '25

Not compatible with Rear Speakers (2890411), sold separately or standard on Ultimate trim

» **PRO R** 4-SEAT • 2890386 **NOT SHOWN**

PRO R 4 '25

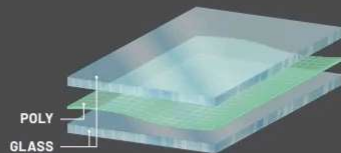

GLASS

VS

HARD COAT POLY

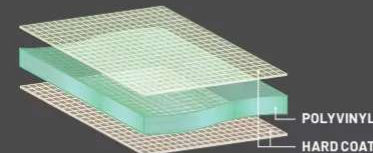

Superior optical clarity (automotive level)
Scratch-resistant
Seals tight
Cold weather/heavy duty

Lightweight, flexible, easy to store/remove
Impact-resistant
30x more scratch resistance than regular poly windshields

RZR PRO R, PRO S & PRO XP



> ROOFS

POLY

POLY SPORT ROOF

- Durable, lightweight polypropylene with contoured design for water run-off
- Maximum protection with full seal for a leak-free barrier and reduced chatter

PRO S	PRO XP	
COLOR	2-SEAT	4-SEAT <small>(NOT SHOWN)</small>
■ MATTE BLACK	2883928	2883946
	PRO S '25, PRO XP '20-25, TURBO R '22-24	PRO S 4 '25, PRO XP 4 '20-25, TURBO R 4 '22-24

ALUMINUM

- High protection strength
- Lower profile
- Sleek style

VS

POLY

- Water run-off
- Pre-existing mounting features
- Lightweight



ALUMINUM

ALUMINUM ROOF

- .32 cm lightweight aluminum stamped sheet with full seal for a leak-free barrier and vibration elimination
- Quick install, low-profile design with maximum protection and durability from the harshest conditions

PRO S	PRO XP	
COLOR	2-SEAT	4-SEAT <small>(NOT SHOWN)</small>
■ MATTE BLACK	2883743-458	2883990-458
■ INDY RED	2883743-293	2883990-293
	PRO S '25, PRO XP '20-25, TURBO R '22-24	PRO S 4 '25, PRO XP 4 '20-25, TURBO R 4 '22-24



PRO S	PRO XP	
COLOR	2-SEAT	4-SEAT <small>(NOT SHOWN)</small>
■ MATTE BLACK	2890430-458	2890431-458
■ INDY RED	2890430-293	2890431-293
	PRO S '25, PRO XP '25	PRO S 4 '25, PRO XP 4 '25



PRO R		
COLOR	2-SEAT	4-SEAT
■ MATTE BLACK	2884237-458	2884325-458
	PRO R '22-25	PRO R 4 '22-25





> DOORS

PRO S PRO XP

UPPER DOORS*

- Designed with thermoformed side shrouds that help seal out dust, water and the elements
- Include zip-out, clear vinyl windows and exterior magnetic closures
- 4-Seat doors have a larger rear window that opens upward, gull-wing style

> 2-SEAT • 2890408

PRO S '25, PRO XP '25

> 4-SEAT • 2890409 NOT SHOWN

PRO S 4 '25, PRO XP 4 '25

Compatible with ROPS-Mounted Side Mirrors (2889099).

Some drivers may experience passenger side mirror obstruction when used with Upper Doors. Use with caution.

PRO R, PRO S & PRO XP

AUDIO

WINDSHIELDS & REAR PANELS

ROOFS, DOORS & CAB ACCESSORIES

VEHICLE PROTECTION

LIGHTING

STORAGE

HARNESSES, MIRRORS, MISC & WINCHES

MAINTENANCE PARTS & FLUIDS

> CAB ACCESSORIES

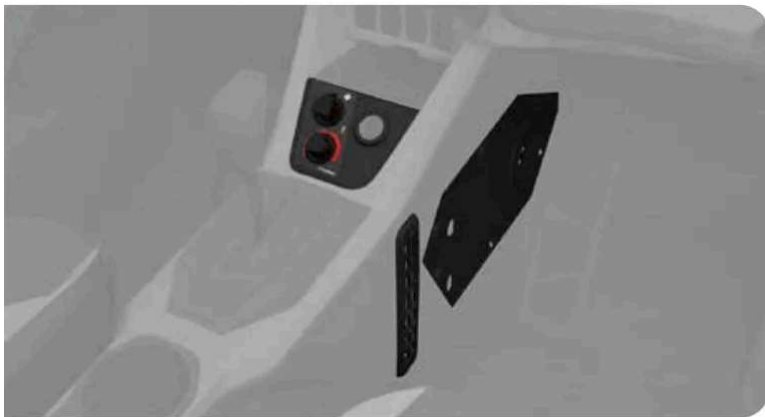

PRO S PRO XP

HEATER KIT NEW

- Connects to the Polaris PULSE bus bar for easy electrical installation
- Fan speed & temperature controls to dial in your comfort
- Closeable driver and passenger floor vents, plus electronic demist vent shutoff

> 2890418

PRO S/4 '25, PRO XP/4 '25



GATORSTEP® ARMREST PADS

- EVA foam pads for added comfort and style

> FRONT • 2891019

PRO R/4 '25, PRO S/4 '25, PRO XP/4 '25

> REAR • 2891113 NOT SHOWN

PRO R 4 '25, PRO S 4 '25, PRO XP 4 '25

GatorStep



PRO R

GATORSTEP® PREMIUM ROOF LINER

- EVA foam pads for added comfort and style

> 2-SEAT • 2891017

PRO R '22-'25

> 4-SEAT • 2891018 NOT SHOWN

PRO R 4 '22-'25

*Fall availability

RZR PRO R, PRO S & PRO XP

> BUMPERS

LOW PROFILE BUMPER

- Durable, powder-coated 3.8 cm - 4.5 cm tube steel with sleek lower profile

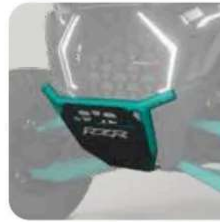

COLOR	PRO XP		PRO S / PRO XP		PRO R / PRO S		PRO R	
	FRONT	REAR	FRONT	REAR	FRONT	REAR	FRONT	REAR
■ MATTE BLACK	2890389-458	2883748-458	2890389-293	2883748-293	2890391-458	2884358-458	2890391-293	2884358-293
■ INDY RED	2890389-293	2883748-293	2890389-647	NA	2890391-647	NA	2890391-751	NA
■ ORANGE BURST	2890389-647	NA	2890389-751	NA	2890391-751	NA	2890391-801	NA
■ POLARIS BLUE METALLIC	2890389-751	NA	2890389-801	NA	2890391-801	NA	2890391-887	NA
■ LIFTED LIME	2890389-801	NA	2890389-887	NA	2890391-887	NA		
■ RADIANT GREEN	2890389-887	NA						
	PRO XP/4 '25		PRO S/4 '25, PRO XP/4 '20-25, TURBO R/4 '22-24		PRO R/4 '25, PRO S/4 '25 Not compatible with a winch		PRO R/4 '22-25	

Bumper Bracket (2889586) required for Front Low Profile Bumper (2890389-XXX) when used on Pro XP/4 Sport '22-25

HIGH COVERAGE BUMPER

- Designed with headlight bezels and a heavy duty tow point

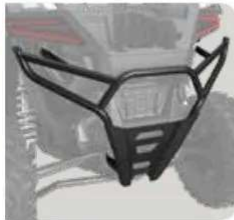

COLOR	PRO XP		PRO S / PRO XP		PRO R / PRO S		PRO R	
	FRONT	REAR	FRONT	REAR	FRONT	REAR	FRONT	REAR
■ MATTE BLACK	2890388-458	2884189-458	2890388-293	2884189-293	2890390-458	2884356-458	2890390-293	NA
■ INDY RED	2890388-293	2884189-293	2890388-647	NA	2890390-647	NA	2890390-751	NA
■ ORANGE BURST	2890388-647	NA	2890388-751	NA	2890390-751	NA	2890390-801	NA
■ POLARIS BLUE METALLIC	2890388-751	NA	2890388-801	NA	2890390-801	NA	2890390-887	NA
■ LIFTED LIME	2890388-801	NA	2890388-887	NA	2890390-887	NA		
■ RADIANT GREEN	2890388-887	NA						
	PRO XP/4 '25		PRO S/4 '25, PRO XP/4 '20-25, TURBO R/4 '22-24		PRO R/4 '25, PRO S/4 '25		PRO R/4 '22-25	

PRE RUNNER BUMPER

- Durable, powder-coated 1.5" steel tube



COLOR	PRO XP		PRO S / PRO XP	
	FRONT	REAR	FRONT	REAR
■ MATTE BLACK	2884581-458	2884585-458	2884581-458	2884585-458
	PRO XP/4 '20-25 Not compatible with a winch		PRO S/4 '25, PRO XP/4 '20-25, TURBO R/4 '22-24	

PRE RUNNER WINCH BUMPER

- Durable, powder-coated 3.8 cm steel tube
- Requires winch (2890402, 2890403), sold separately



COLOR	PRO R / PRO S	
	FRONT	REAR
■ MATTE BLACK	2884355-458	
	PRO R/4 '22-25, PRO S/4 '25, TURBO R/4 '22-24	



> FENDER FLARES & GRILLES



FULL COVERAGE FENDER FLARES

- Maximize coverage with extended fenders and removable mud flaps
- Front and rear included

> 2890407

PRO R/4 '25, PRO S/4 '25, PRO XP/4 '25



PRO ARMOR ALUMINUM FRONT GRILLE

- Aluminum construction with an added pop of color



COLOR	PRO S	PRO XP	PRO R
	FRONT	FRONT	FRONT
INDY RED	2890406-293	NA	NA
ORANGE BURST	2890406-647	NA	NA
POLARIS BLUE METALLIC	NA	NA	2891093-751
LIFTED LIME	2890406-801	NA	2891093-801
RADIANT GREEN	NA	NA	2891093-887

PRO S/4 '25, PRO XP/4 '25 PRO R/4 '25



> ROCK SLIDERS



12-GAUGE STAMPED STEEL
NO LOSS IN GROUND CLEARANCE



4.5 cm STEEL TUBE CONSTRUCTION WITH
70% THICKER WALLS, EXTENDS FROM MACHINE FOR
MAX PROTECTION THROUGH ROUGH TERRAIN

LOW PROFILE

COLOR	2-SEAT	4-SEAT
MATTE BLACK	2890394-458	2890395-458
INDY RED	2890394-293	2890395-293
ORANGE BURST	2890394-647	2890395-647
POLARIS BLUE METALLIC	2890394-751	2890395-751
LIFTED LIME	2890394-801	2890395-801
RADIANT GREEN	2890394-887	2890395-887

PRO R '22-25, PRO S '25, PRO XP '20-25, TURBO R '22-24 PRO R 4 '22-25, PRO S 4 '25, PRO XP 4 '20-25, TURBO R 4 '22-24

HD EXTREME KICK-OUT

COLOR	2-SEAT	4-SEAT
MATTE BLACK	2890396-458	2890397-458
INDY RED	2890396-293	2890397-293
ORANGE BURST	2890396-647	2890397-647
POLARIS BLUE METALLIC	2890396-751	2890397-751
LIFTED LIME	2890396-801	2890397-801
RADIANT GREEN	2890396-887	2890397-887

PRO R '22-25, PRO S '25, PRO XP '20-25, TURBO R '22-24 PRO R 4 '22-25, PRO S 4 '25, PRO XP 4 '20-25, TURBO R 4 '22-24

SEAMLESS INSTALLATION
Reusable anchors allow for easy installation of rock sliders into the built-in, dedicated chassis location.



CLOSED/UNLOCKED



OPEN/LOCKED

RZR PRO R, PRO S & PRO XP

> LIGHTING



ADVANCED TECH

RIGID® lights are driven by Aluminum PCB Smart Boards®, 6063-T5 aircraft aluminum extruded housings and Tiger Drylac® UV protection polyester powdercoating.

EXCLUSIVE OPTICS

RIGID® invests heavily in optical science and has patented multiple optics and optics systems, maximizing light output and efficiency.

LIGHT BAR OPTIONS

1. CHOOSE YOUR LIGHT BAR



BRAND SIZE RIGID 15.2 CM
TYPE DUAL-ROW E-SERIES
RAW LUMENS 9,504
PN 2884648*
FITMENT PRO R/4 '22-25, PRO S/4 '25, PRO XP/4 '20-25, TURBO R/4 '22-24



BRAND SIZE RIGID 81.3 CM
TYPE SR-SERIES
RAW LUMENS 20,064
PN 2884648*
FITMENT PRO R/4 '22-25, PRO S/4 '25, PRO XP/4 '20-25, TURBO R/4 '22-24

MOUNTS TO ROOF FOR MAXIMUM VISIBILITY



RIGID CHASE LIGHT

- Bright, daylight visible lighting with eleven selectable modes, including white scene lighting for accessing cargo bed in the dark
- Connects into brake light system for additional high mount brake light

» 2884359*
 PRO R/4 '22-25, PRO S/4 '25, PRO XP/4 '20-25, TURBO R/4 '22-24

*Not available in Europe

MOUNT OPTIONS

2. ADD A MOUNT

15.2 CM LIGHT BAR MOUNT

PRO XP
 2884654
 PRO XP/4 '20-25

PRO R PRO S
 2884595
 PRO R/4 '22-25, PRO S/4 '25, TURBO R/4 '22-24

81.3 CM LIGHT BAR MOUNT

PRO S PRO XP
 2884650
 PRO S/4 '25, PRO XP/4 '20-25, TURBO R/4 '22-24

PRO R
 2884601
 PRO R/4 '22-25

CHASE LIGHT MOUNT KIT

2884896
 PRO R/4 '22-25, PRO S/4 '25, PRO XP/4 '20-25, TURBO R/4 '22-24

HARNESS OPTIONS

3. ADD A HARNESS

LIGHT BAR SET-UPS

MODEL	1 LIGHT IN 1 LOCATION ON 1 SWITCH	2 LIGHTS IN 2 LOCATIONS ON 2 SWITCHES	CHASE LIGHT
PRO R/4 '22-25 PRO S/4 '25 PRO XP/4 '20-25 TURBO R/4 '22-24	POLARIS PULSE LIGHT BAR HARNESS 2883949 POLARIS PULSE HD LIGHT BAR HARNESS 2889130 FOR LIGHTS THAT DRAW OVER 10A	POLARIS PULSE LIGHT BAR HARNESS (x2) 2883949 POLARIS PULSE HD LIGHT BAR HARNESS (x2) 2889130 FOR LIGHTS THAT DRAW OVER 10A	CHASE LIGHT HARNESS KIT 2890052 2025 FITMENT ONLY

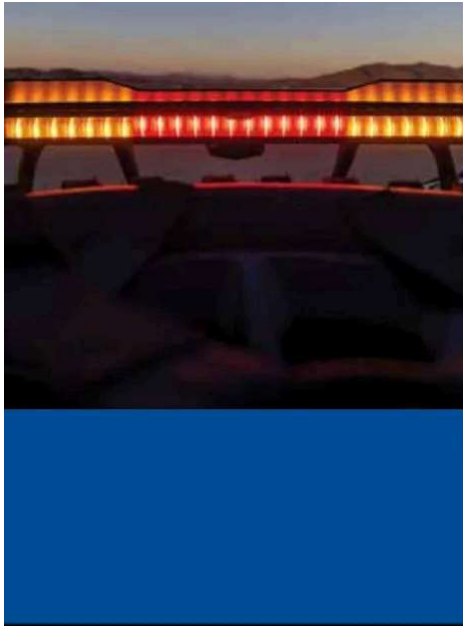

PRO R, PRO S & PRO XP

AUDIO

WINDSHIELDS & REAR PANELS

ROOFS, DOORS & CAB ACCESSORIES

VEHICLE PROTECTION

LIGHTING

STORAGE

HARNESSES, MIRRORS, MISC & WINCHES

MAINTENANCE PARTS & FLUIDS



PRO ARMOR ROCK LIGHTS

- Add style and nighttime functionality to your vehicle
- Universal mounting for wheel wells or other desired vehicle locations

- » WHITE • 2884645
- » RED • 2884683
- » BLUE • 2884684

PRO R/4 '22-'25, PRO S/4 '25,
PRO XP/4 '20-'25, TURBO R/4 '22-'24



ACCENT LIGHT KIT

- Durable construction resists dust and water while on the trails
- Front fascia LED accent light

- » 2890517
- PRO R/4 '25, PRO S/4 '25, PRO XP/4 '25
STANDARD ON ULTIMATE TRIM

POLARIS ENGINEERED ADVANTAGES



PLUG & PLAY ELECTRICAL

POLARIS PULSE IS A REVOLUTIONARY way to provide power to your vehicle and makes adding electrical accessories a snap.



SEE FULL LIGHTING OPTIONS P. 68

RZR PRO R, PRO S & PRO XP



> STORAGE



FORWARD CARGO BOX TOP SELLER

- Easy-to-use latches and molded side handles
- Durable polypropylene, engineered to seal out dust and water
- Lock & Ride strongly secures the box to the cargo bed

» **PRO S** **PRO XP**

69 L • 2883751

PRO S/4 '25, PRO XP/4 '20-25,
TURBO R/4 '22-24

» **PRO R**

57 L • 2884235

PRO R/4 '22-25



Fit: 2 Full-Size Helmets | Tool Kit | Jacket/Coat | Food & Drinks



REAR CARGO BOX

- Easy-to-use latches and molded side handles
- Durable polypropylene, engineered to seal out dust and water
- Lock & Ride strongly secures the box to the cargo bed

» **PRO S** **PRO XP**

40 L • 2883752

PRO S/4 '25, PRO XP/4 '20-25,
TURBO R/4 '22-24

» **PRO R**

34 L • 2884236

PRO R/4 '22-25

Fit: Sleeping Bag | First Aid Kit | Snacks | Sunscreen

FORWARD CARGO AND REAR CARGO STORAGE BOXES NEST PERFECTLY TOGETHER

REAR CARGO STORAGE BOX AND 28 L NORTHSTAR COOLER NEST PERFECTLY TOGETHER

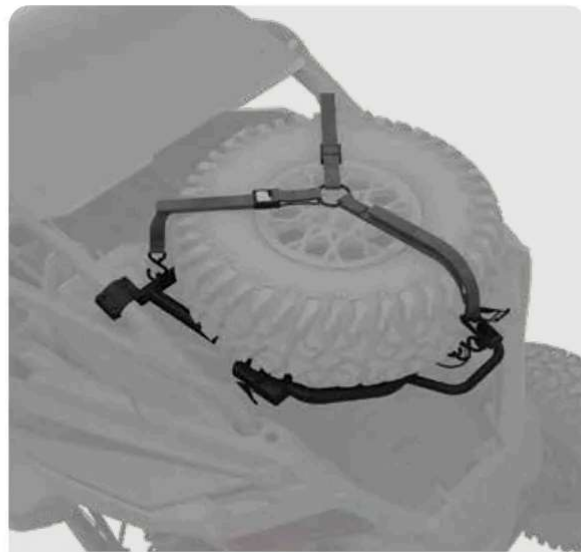

PIVOTING SPARE TIRE CARRIER

- Secure mounting with dual latches
- Steel mounts and rack
- Holds up to a 33" tire and supports 34 kg of weight
- Single-handed release mechanism

» **PRO S** **PRO XP** 2889404-458

PRO S/4 '25, PRO XP/4 '20-25, TURBO R/4 '22-24

» **PRO R** 2890863-458

PRO R/4 '22-25

Not compatible with Rear Speaker Pods (2883945)



28 L REAR COOLER

- Lid locks securely in place with rubber latches to protect cargo
- Provides plenty of storage without weighing you down
- Keeps your food, beverages and bait fresh while out on the trails
- Nests with forward cargo box

» 2889740

PRO R/4 '22-25, PRO S/4 '25, PRO XP/4 '20-25, TURBO R/4 '22-24



POLARIS NORTHSTAR 28 L COOLER

- Nests with rear cargo box
- » GRAPHITE • 2883424
- » SAGEBRUSH GREEN • 2890706

PRO R/4 '22-25, PRO S/4 '25, PRO XP/4 '20-25, TURBO R/4 '22-24



NORTHSTAR 28 L COOLER BRACKET

» **PRO S** **PRO XP** 2884070

PRO S/4 '25, PRO XP/4 '20-25, TURBO R/4 '22-24

» **PRO R** 2889200

PRO R/4 '22-25

Not compatible with Pivoting Spare Tire Carrier (2890863-458)



SEE P. 72 FOR FULL DETAILS

5.7 L DOOR STORAGE BAG

- Quick reach access to keep supplies and gear secure
- Waterproof zipper keeps everything enclosed, clean and dry
- Molded face with EVA carbon fiber vinyl cover design

» **FRONT** • 2890387

PRO R/4 '25, PRO S/4 '25, PRO XP/4 '25

» **REAR** • 2890516

PRO R/4 '25, PRO S/4 '25, PRO XP/4 '25



Fit: Cell Phone | Gloves | Sunscreen

9.5 L SHOULDER STORAGE BAG

- Keeps your belongings safe and secure
- Molded sides, lid inserts, waterproof zipper and a nylon mesh pocket for versatile storage options
- Easy install and quick access with a sleek cockpit look

» 2889785

PRO R/4 '22-25, PRO S/4 '25, PRO XP/4 '20-25, TURBO R/4 '22-24

Fits between rear seats on 4-Seat models



Fit: Flashlight | Snacks | Sunglasses | Bug Spray

SEE COVERS AND STRAPS P. 82

RZR PRO R, PRO S & PRO XP



> HARNESSES

US MODELS ONLY - NOT AVAILABLE IN EUROPE



CLICK6 HARNESS KIT*

- Racing-quality, premium construction for increased security
- Six straps with retractable shoulder straps to hold a rider securely in place
- One-click, quick-release buckle releases straps, allowing easy egress
- Fully adjustable to fit riders of all sizes

2-SEAT

» 2891261

PRO R '25, PRO S '25, PRO XP '25

4-SEAT

» 2891262

PRO R 4 '25, PRO S 4 '25, PRO XP 4 '25

*Fall availability

> MIRRORS

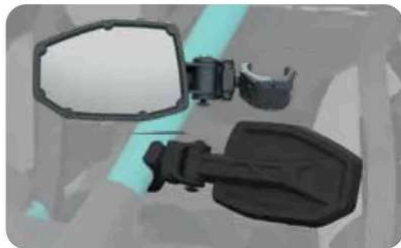

PRO ARMOR SIDE MIRRORS

- Provides greater rearward visibility
- Designed with a convex mirror
- Durable, all-aluminum construction

» 2891232

PRO R/4 '22-25, PRO S/4 '25,
PRO XP/4 '20-25, TURBO R/4 '22-24



PREMIUM CONVEX REARVIEW MIRROR TOP SELLER

- Installs in minutes and integrates into a designated mounting position
- Laminated safety glass for excellent scratch resistance

» 2883763

PRO R/4 '22-25, PRO S/4 '25,
PRO XP/4 '20-25, TURBO R/4 '22-24

> MISC



SECONDARY BATTERY MOUNT KIT

- Provides longer lasting 12V output
- Battery sold separately

» 2-SEAT • 2884347

PRO R '22-25, PRO S '25, PRO XP '20-25, TURBO R '22-24
STANDARD ON PRO R ULTIMATE MODELS

» 4-SEAT • 2890572

PRO R 4 '25, PRO S 4 '25, PRO XP 4 '25
STANDARD ON PRO R 4 ULTIMATE MODELS



> WINCHES

PRO R, PRO S & PRO XP

AUDIO

WINDSHIELDS
& REAR PANELS

ROOFS, DOORS
& CAB ACCESSORIES

VEHICLE PROTECTION

LIGHTING

STORAGE

HARNESSES, MIRRORS,
MISC & WINCHES

MAINTENANCE PARTS
& FLUIDS



FEATURES	PRO HD SERIES		REPLACEMENT PARTS
RAPID ROPE RECOVERY	STANDARD		
AUTO STOP TECHNOLOGY	STANDARD		
WINCH LINE	SYNTHETIC ROPE		
CONTROL	WIRELESS & WIRED STANDARD		
MODEL	2,721 kg	2,041 kg	
PRO R PRO S PRO R/4 '25 PRO S/4 '25 Includes dash switch and wireless remote	2890403	2890402	15 M SYNTHETIC ROPE 2,721 kg SERIES » 2879188 2,041 kg SERIES » 2879187
PRO XP PRO XP/4 '25 Includes dash switch and wireless remote	2890399	2890398	

SEE ADDITIONAL WINCH INFORMATION P. 66

RZR PRO R, PRO S & PRO XP

MAINTENANCE PARTS & FLUIDS



POLARIS ENGINEERED PARTS AND OIL have been validated and tested extensively, specifically for your vehicle. In order to maintain the peak performance of your Polaris vehicle only use official Polaris Engineered parts and oil.



We're taking the passion of our riders, workers, and outdoor enthusiasts to the next level with HD Parts. These Heavy Duty parts are engineered for riders who want greater durability and enhanced performance. HD Parts are designed and tested to handle greater wear and tear under all weather conditions.



A DRIVE BELT

- » 3211202
PRO XP, PRO S, TURBO R
- » **HD** • 3211227
PRO XP, PRO S, TURBO R
- » 3211226
PRO R



B BRAKE PADS

- » FRONT • 2208162
PRO XP
- » REAR • 2208161
PRO XP
- » FRONT • 2211640
PRO R, PRO S, TURBO R
- » REAR • 2211643
PRO R, PRO S, TURBO R



C OIL FILTER

- » 2520799
PRO XP, PRO S, TURBO R
- » **HD** • 2522498
PRO XP, PRO S, TURBO R
- » 2521728
PRO R



D BATTERY

- » 4014609



E AIR FILTER

- » 1241084
PRO XP, PRO S, TURBO R
- » 7082436
PRO R
- » **HD** • 2882234
PRO XP, PRO S, TURBO R



F SPARK PLUGS

- » 3023173
PRO XP, PRO S, TURBO R
- » 3023413
PRO R

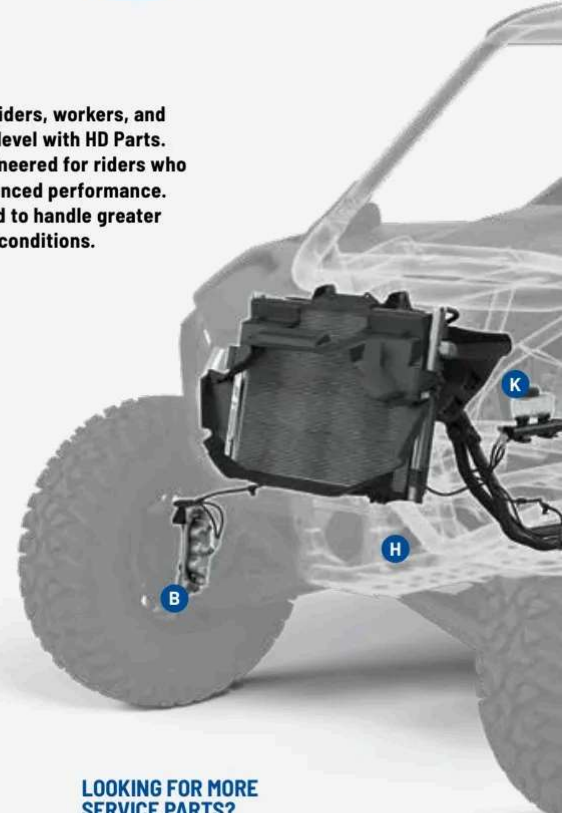

LOOKING FOR MORE SERVICE PARTS?

See P. 95 to learn how to find parts for your model.

MAINTENANCE SCHEDULE*

BREAK-IN MAINTENANCE

- FIRST 25 HRS | 250 MI / 400 KM
- ENGINE OIL & OIL FILTER CHANGE**
- GENERAL LUBRICATION**
ALL FITTINGS, PIVOTS, CABLES, ETC.
- AIR FILTER INSPECT**
REPLACE AS NEEDED
- BATTERY TEST, CLEAN**
REPLACE AS NEEDED
- FRONT GEARCASE INSPECT**
ADD FLUID AS NEEDED
- TRANSMISSION INSPECT FLUID**
ADD FLUID AS NEEDED

6 MONTHS

- 25 HRS | 500 MI / 800 KM
- BRAKE PADS INSPECT**
REPLACE AS NEEDED
- BRAKE FLUID INSPECT**
ADD AS NEEDED
- AIR FILTER INSPECT**
REPLACE AS NEEDED
- BATTERY TEST & CLEAN**
REPLACE AS NEEDED

12 MONTHS

- 50 HRS | 1,000 MI / 1,600 KM
- BRAKE PADS INSPECT**
REPLACE AS NEEDED
- BRAKE FLUID INSPECT**
ADD AS NEEDED
- ENGINE OIL & OIL FILTER CHANGE**
- AIR FILTER INSPECT**
REPLACE AS NEEDED
- BATTERY TEST & CLEAN**
REPLACE AS NEEDED
- FRONT GEARCASE CHANGE FLUID**
- DRIVE BELT INSPECT & ADJUST**
REPLACE AS NEEDED
- PRO XP
TRANSMISSION CHANGE FLUID

18 MONTHS

- 150 HRS | 1,500 MI / 2,400 KM
- BRAKE PADS INSPECT**
REPLACE AS NEEDED
- BRAKE FLUID INSPECT**
ADD AS NEEDED
- AIR FILTER INSPECT**
REPLACE AS NEEDED
- BATTERY TEST & CLEAN**
REPLACE AS NEEDED

G

ENGINE OIL P. 84

- » PS-4 • 1 L • 502484
- » PS-4 • 4 L • 502485
- » PS-4 EXTREME • 1 L • 503220
- » PS-4 EXTREME • 4 L • 503221

H

DEMAND DRIVE FLUID

For front gearcase.

- » 1 L • 502563
- » 25 L • 502564
- » 200 L • 502565

I

ANGLE DRIVE FLUID 80W-140

For rear gearcase

- » 1 L • 503320
- » 25 L • 503318
- » 202 L • 503317

PRO R

J

AGL

For transmission

- » 1 L • 502505
- » 25 L • 502507
- » 200 L • 502508

K

DOT 4 BRAKE FLUID

- » 250 ML • 502526

ALL-SEASON GREASE TUBE

- » 400 G • 502538

Claims made based off testing and performance of Polaris HD Parts against standard OEM parts made by Polaris and competitor brands under normal use. For more information regarding Polaris HD parts including vehicle compatibility, installation and maintenance, please contact your authorized Polaris ORV dealer.

<h2 style="margin: 0;">24 MONTHS</h2> <p style="margin: 0;">200 HRS 2,000 MI / 3,200 KM</p>	<h2 style="margin: 0;">30 MONTHS</h2> <p style="margin: 0;">250 HRS 2,500 MI / 4,000 KM</p>	<h2 style="margin: 0;">36 MONTHS</h2> <p style="margin: 0;">300 HRS 3,000 MI / 4,800 KM</p>
<ul style="list-style-type: none"> BRAKE PADS INSPECT REPLACE AS NEEDED BRAKE FLUID CHANGE ENGINE OIL & OIL FILTER CHANGE AIR FILTER INSPECT REPLACE AS NEEDED BATTERY TEST & CLEAN REPLACE AS NEEDED 	<ul style="list-style-type: none"> FRONT GEARCASE CHANGE FLUID DRIVE BELT INSPECT & ADJUST REPLACE AS NEEDED PRO XP TRANSMISSION CHANGE FLUID BRAKE PADS INSPECT REPLACE AS NEEDED BRAKE FLUID INSPECT ADD AS NEEDED AIR FILTER INSPECT REPLACE AS NEEDED BATTERY TEST & CLEAN REPLACE AS NEEDED 	<ul style="list-style-type: none"> FRONT GEARCASE CHANGE FLUID DRIVE BELT INSPECT & ADJUST REPLACE AS NEEDED PRO XP TRANSMISSION CHANGE FLUID BRAKE PADS INSPECT REPLACE AS NEEDED BRAKE FLUID INSPECT ADD AS NEEDED ENGINE OIL & OIL FILTER CHANGE AIR FILTER INSPECT REPLACE AS NEEDED BATTERY TEST & CLEAN REPLACE AS NEEDED

FOR A COMPLETE MAINTENANCE SCHEDULE, CHECK YOUR OWNER'S MANUAL



*This is a sample maintenance schedule. Please reference and use your owners manual for full maintenance and vehicle care.

RZR XP

POLARIS
RZR XP





> TRAIL PACKAGE

2884562	Stage 4 Audio Upgrade by Rockford Fosgate®: P. 34	2884649	RIGID® E-Series 15.2 cm Light Bar: P. 42
2884542	 Full Vented Windshield - Hard Coat Poly: P. 37	2884510	15.2 cm Light Bar Mount: P. 42
2884519	 Rear Panel - Hard Coat Poly: P. 37	2884530	8 L Shoulder Storage Bag: P. 44
2884513-293	Front High Coverage Bumper: P. 40	2884528	4.7 L Door Storage Bag: P. 44
2884514-293	Rear High Coverage Bumper: P. 40	2884548	Tonneau Cover: P. 45
2884512-293	HD Extreme Kick-Out Rock Sliders, 4-Seat: P. 41	2884546-458	Pivoting Spare Tire Carrier: P. 45
2889133	Full Coverage Fender Flares: P. 41	2883763	Premium Convex Rearview Mirror: P. 46
2884648	RIGID® SR-Series 81.3 cm Combo LED Light Bar: P. 42	2884524	Adjustable Folding Side Mirrors: P. 46
2884650	81.3 cm Light Bar Mount: P. 42	2884836	Polaris Pro HD 2,041 kg Winch: P. 47
2889291	Polaris PULSE Light Bar Harness: P. 42	5415616	Pro Armor Spare Tire: Crawler XG, 30": P. 76
2884359	RIGID® Chase Light: P. 42	5418036	Pro Armor Spare Wheel: 4302 Beadlock, 14": P. 79
2889121	Chase Light Mount Kit: P. 42	2889555	Pro Armor Wheel & Tire Set: 4302 Beadlock & Crawler XG, 30": P. 81
2889293	Chase Light Harness Kit: P. 42		



➤ MUD PACKAGE

2884561	Stage 2 Audio Upgrade by Rockford Fosgate®: P. 34	2889291	Polaris PULSE Light Bar Harness: P. 42
2889292	Stage 3 Audio Upgrade by Rockford Fosgate®*: P. 34	2884525	 52 L Rear Cargo Box: P. 44
2884562	Stage 4 Audio Upgrade by Rockford Fosgate®: P. 34	2884530	8 L Shoulder Storage Bag: P. 44
2883945	Rear Speaker Pods by Rockford Fosgate®: P. 34	2884528	4.7 L Door Storage Bag: P. 44
2884539	 Half Windshield - Hard Coat Poly: P. 37	2883424	Polaris NorthStar 28 L Cooler: P. 45
2884513-458	Front High Coverage Bumper: P. 40	2884526	 NorthStar 28 L Cooler Bracket: P. 45
2884514-458	Rear High Coverage Bumper: P. 40	2883763	Premium Convex Rearview Mirror: P. 46
2889133	Full Coverage Fender Flares: P. 41	2884836	Polaris Pro HD 2,041 kg Winch: P. 47
2884648	RIGID® SR-Series 81.3 cm Combo LED Light Bar: P. 42	2890165	Pro Armor Wheel & Tire Set: 5305 Beadlock & Mud XC, 30": P. 80
2884650	81.3 cm Light Bar Mount: P. 42		

Shown on XP 2-Seat. Applicable to all models with adjustments.
*Stock on Ultimate trim.

XP

AUDIO

WINDSHIELDS
& REAR PANELSROOFS, DOORS
& HEATER

VEHICLE PROTECTION

LIGHTING



STORAGE

MIRRORS, HARNESSSES,
& WINCHESMAINTENANCE PARTS
& FLUIDS

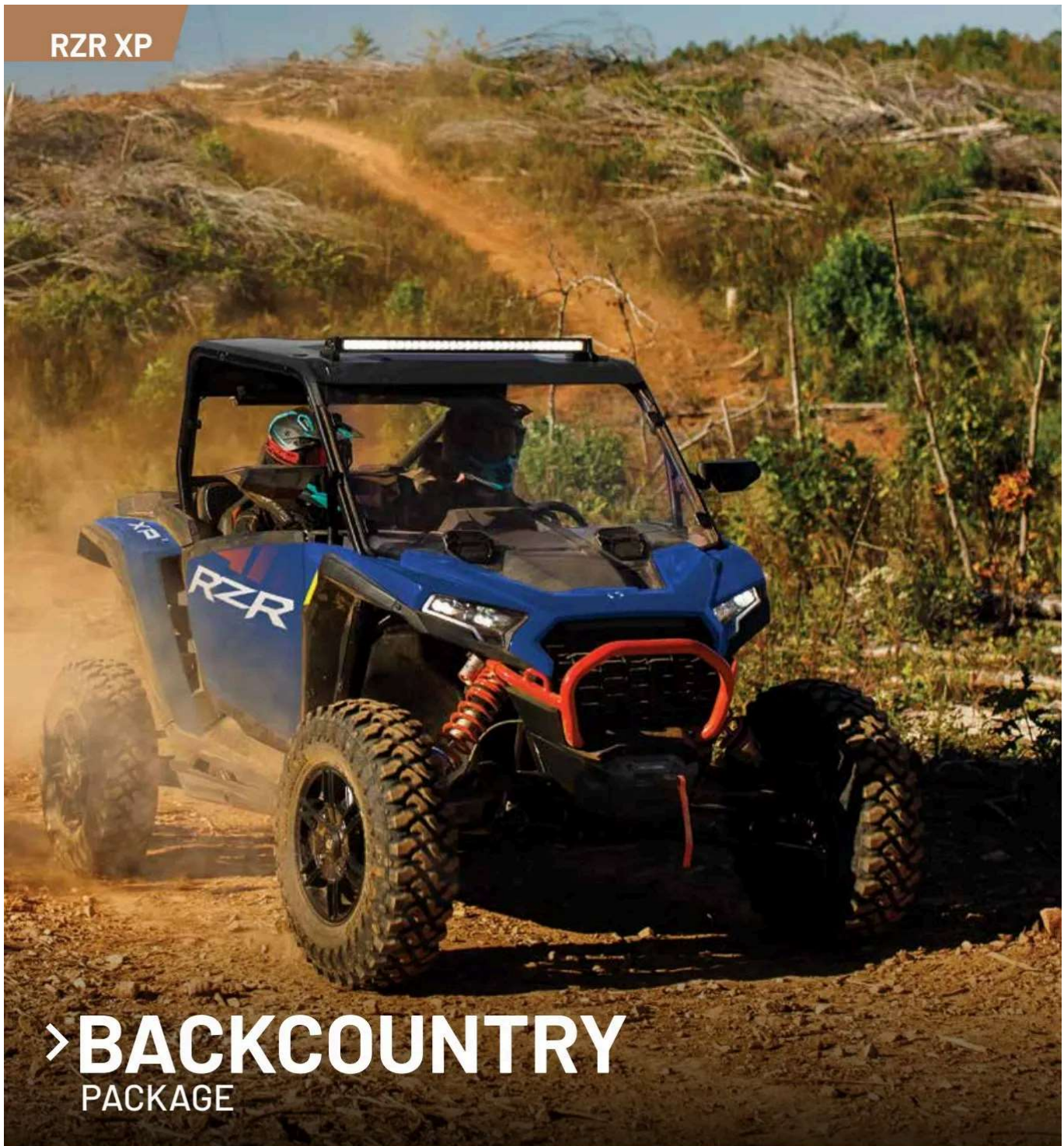
RZR XP



➤ BACKCOUNTRY PACKAGE

2889614	Stage 5 Audio Upgrade by Rockford Fosgate®: P. 34	2889293	Chase Light Harness Kit: P. 42
2884542	 Full Vented Windshield - Hard Coat Poly: P. 37	2889611	 78 L Forward Cargo Box: P. 44
2884549-293	Aluminum Roof, 2-Seat: P. 38	2884530	8 L Shoulder Storage Bag: P. 44
2884472-293	Low Profile Rock Sliders, 2-Seat: P. 41	2889612	 26 L Rear Cooler: P. 45
2884648	RIGID® SR-Series 81.3 cm Combo LED Light Bar: P. 42	2883763	Premium Convex Rearview Mirror: P. 46
2884650	81.3 cm Light Bar Mount: P. 42	2884524	Adjustable Folding Side Mirrors: P. 46
2889291	Polaris PULSE Light Bar Harness: P. 42	2885030	Pro Armor Wheel & Tire Set: 5204 & Pro Runner, 30": P. 81
2884359	RIGID® Chase Light: P. 42		
2889121	Chase Light Mount Kit: P. 42		



> ALL-SEASON PACKAGE

2885003	Stage 1 Audio Kit by Rockford Fosgate**: P. 34	2884512-458	HD Extreme Kick-Out Rock Sliders, 4-Seat: P. 41
2884545	Full Vented Windshield - Glass: P. 37	2889133	Full Coverage Fender Flares: P. 41
2884579	Glass Windshield Wiper Kit: P. 37	2884528	4.7 L Door Storage Bag: P. 44
2884519	 Rear Panel - Hard Coat Poly: P. 37	2884548	Tonneau Cover: P. 45
2884554	Poly Sport Roof, 4-Seat**: P. 38	2883763	Premium Convex Rearview Mirror: P. 46
2884534	Upper Doors, 4-Seat: P. 39	2884524	Adjustable Folding Side Mirrors: P. 46
2884523	Heater Kit: P. 39	2884835	Polaris HD 2,041 kg Winch: P. 47
2884513-458	Front High Coverage Bumper: P. 40	2883166	Pro Armor Wheel & Tire Set: 5202 & Attack 2.0, 30": P. 80
2884514-458	Rear High Coverage Bumper: P. 40		

Shown on XP 4-Seat. Applicable to all models with adjustments.
*Stock on Premium trim, not compatible with Ultimate trim.
**Stock on Premium/Ultimate trims

XP

AUDIO

WINDSHIELDS
& REAR PANELSROOFS, DOORS
& HEATER

VEHICLE PROTECTION

LIGHTING

STORAGE

MIRRORS, HARNESSES,
& WINCHESMAINTENANCE PARTS
& FLUIDS

RZR XP



> AUDIO



Rockford Fosgate partnered with Polaris to create the next evolution of factory-installed off-road audio. Purpose-built to stand up to any outdoor environment and designed to perform no matter the ride. Specifically tuned and rider-centric to create an audio experience that is second to none.

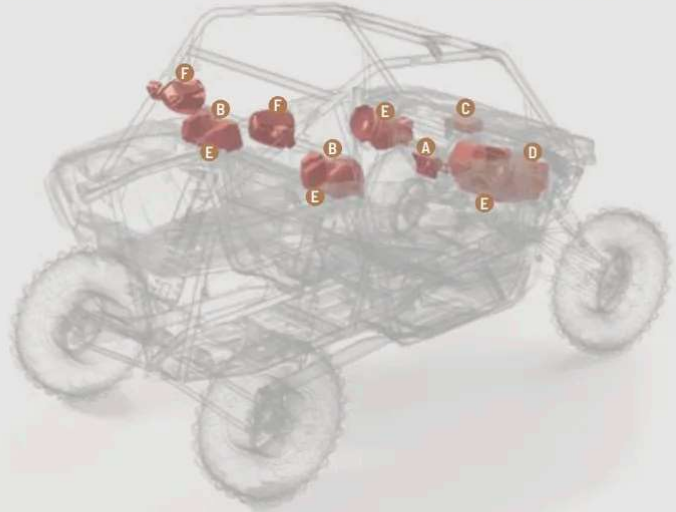

PLUG & PLAY



ELEMENT READY



NO LOSS OF CARGO SPACE



BLUETOOTH

SOURCE UNITS

- Tuned to combat wind and motor noise, delivering an incredible sound no matter the speed
- Element ready design guards against dust and moisture intrusion

AMPLIFIERS

- Ultra compact CLEAN technology
- Highly efficient design capable of being pushed hard without overheating

SPEAKERS

- Off-road optimized Element Ready speakers thrive in any outdoor environment
- Specifically tuned enclosures create rich cockpit sound
- Rugged, yet lightweight, materials that don't sacrifice speed for sound

SUBWOOFERS

- High-power, high-excursion subwoofer that acoustically couples with the cockpit for perfect bass response
- Torture tested for long life and performance



A. STAGE 1
PMX-P2 HEAD UNIT & 16.51 CM DASH SPEAKERS

- 6.86 cm full color display
- AM/FM/WB tuner*, Pandora control, Bluetooth connectivity
- Includes mount kit
- 50 watt 16.51 cm coaxial speakers with enclosures

» 2885003
XP/4 '24-25
STANDARD ON 2024 PREMIUM MODELS
NOT COMPATIBLE WITH ULTIMATE MODELS



B. STAGE 2
16.51 CM REAR SPEAKERS

- 50 watt 16.51 cm coaxial speakers and enclosures

» 2884561
XP/4 '24-25
STANDARD ON ULTIMATE MODELS



C. STAGE 3
AMPLIFIER UPGRADE KIT

- 400 watt full range amplifier

» 2889292
XP/4 '24-25
STANDARD ON ULTIMATE MODELS



D. STAGE 4
25.4 CM POWERED SUBWOOFER

- 25.4 cm subwoofer with enclosure and grille
- 400 watt integrated subwoofer amplifier

» 2884562
XP/4 '24-25
Stage 3 Audio (2889292) required, sold separately
Not compatible with Stage 5 Audio



E. STAGE 5
30 CM POWERED SUBWOOFER WITH FULL SYSTEM SPEAKER UPGRADE

- 400 watt 30 cm subwoofer with enclosure and grille
- 100 watt dash speakers (x2)
- 100 watt rear speakers with enclosures and stainless steel grilles
- 2x more power and sound delivery over the stock system

» 2889614
XP/4 '24-25
Stage 3 Audio (2889292) required, sold separately
Not compatible with Stage 4 Audio or Rear Pods



F. REAR PODS
USE WITH STAGES 1-4

- 50 watt 16.51 cm coaxial speakers with can-enclosures, mounting hardware and grilles

» 2883945
XP/4 '24-25
Not compatible with Stage 5 Audio Upgrade (2889614)



- XP
- AUDIO
- WINDSHIELDS & REAR PANELS
- ROOFS, DOORS & HEATER
- VEHICLE PROTECTION
- LIGHTING
- STORAGE
- MIRRORS, HARNESSSES & WINCHES
- MAINTENANCE PARTS & FLUIDS

BUILD YOUR SOUND

(CHOOSE THE PATH THAT MATCHES YOUR RZR)

FACTORY-INSTALLED

SKIP TO STEP 2



XP PREMIUM
PMX-P2 + STAGE 1



XP ULTIMATE
RIDE COMMAND + STAGE 3

NO FACTORY AUDIO

STEP 1
ADD BASE AUDIO

STAGE 1
PMX-P2 HEAD UNIT & 16.51 CM DASH SPEAKERS
2885003
XP/4 '24-25
STANDARD ON PREMIUM MODELS
NOT COMPATIBLE WITH ULTIMATE MODELS

STEP 2
UPGRADE AUDIO

STAGE 2
16.51 CM REAR SPEAKERS
2884561
XP/4 '24-25
STANDARD ON ULTIMATE MODELS

+ / OR

STAGE 3
AMPLIFIER UPGRADE KIT
2889292
XP/4 '24-25
STANDARD ON ULTIMATE MODELS

+ / OR

REAR PODS
2883945
XP/4 '24-25
Not compatible with Stage 5 Audio Upgrade (2889614)
ADD TO STAGES 1-4

STEP 3
CRANK THE BASS

STAGE 4
25.4 CM POWERED SUBWOOFER
2884562
XP/4 '24-25
Stage 3 Audio (2889292) required, sold separately
NOT COMPATIBLE WITH STAGE 5 AUDIO

OR

STAGE 5
30 CM POWERED SUBWOOFER WITH FULL SYSTEM SPEAKER UPGRADE
2889614
XP/4 '24-25
Stage 3 Audio (2889292) required, sold separately
NOT COMPATIBLE WITH STAGE 4 AUDIO OR REAR PODS



RZR XP



> BUILD YOUR CAB

ADD COMFORT AND STYLE WITH END-TO-END PROTECTION



ADD A WINDSHIELD
Protect all riders with optical clarity.

ADD A ROOF
Shield from harsh elements while adding style.

ADD A REAR PANEL
Maintain rear visibility while reducing rear air swirl.

ADD UPPER DOORS
Keep the cab free of dust and water.

RECOMMENDED 2-SEAT CAB

- 2884545 • Full Vented Windshield - Glass
- 2884579 • Glass Windshield Wiper Kit
- 2884519 • Rear Panel - Hard Coat Poly
- 2884553 • Poly Sport Roof
- 2889402 • Exterior Door Latch

Available on 2-Seat and 4-Seat vehicles.

RECOMMENDED 4-SEAT CAB

- 2884539 • Half Windshield - Hard Coat Poly
- 2884519 • Rear Panel - Hard Coat Poly
- 2884551-458 • Aluminum Roof
- 2889402 • Exterior Door Latch
- 2889403 • Exterior Door Latch (Rear)

Available on 2-Seat and 4-Seat vehicles.



PROFILE ROOPS

Provides a flat sealing surface for the glass windshield gasket and indentation along the A-pillar for optimized fit.



POLARIS ENGINEERED ADVANTAGES

DASH GROOVE

Dedicated nesting location along the dash for windshields to rest, creating a tighter seal to eliminate air gaps.

XP

WINDSHIELDS

GLASS



FULL VENTED WINDSHIELD - GLASS TOP SELLER

- Double-layer, laminated and tempered glass windshield with steel, powder-coated frame and adjustable center vents
- ECE R43 certified

» 2884545
XP/4 '24-25



GLASS WINDSHIELD WIPER KIT TOP SELLER

- Simple to control with a multi-function, dash-mounted switch
- Includes a washer fluid reservoir

» 2884579
XP/4 '24-25
Compatible with glass windshield only



AUDIO

WINDSHIELDS & REAR PANELS

ROOFS, DOORS & HEATER

VEHICLE PROTECTION

HARD COAT POLY



LR FULL VENTED WINDSHIELD - HARD COAT POLY

- Impact-resistant, long-lasting .64 cm durable hard coated polycarbonate
- Full protection with airflow vents that quickly open for cockpit ventilation

» 2884542
XP/4 '24-25



LR FULL WINDSHIELD - HARD COAT POLY

- Impact-resistant, long-lasting .64 cm durable hard coated polycarbonate
- No frame design offers maximum visibility
- Integrates with all cab components

» 2884540
XP/4 '24-25



LR HALF WINDSHIELD - HARD COAT POLY TOP SELLER

- Provides added protection from the elements, while allowing optimum airflow and visibility
- 18 cm tall

» 2884539
XP/4 '24-25

LIGHTING

STORAGE

MIRRORS, HARNESSSES & WINCHES

MAINTENANCE PARTS & FLUIDS

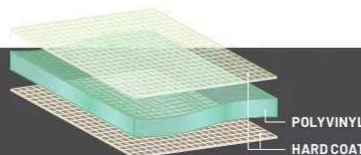
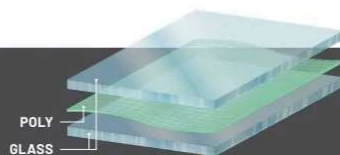

GLASS VS HARD COAT POLY

Superior optical clarity (automotive level)
Scratch-resistant
Seals tight
Cold weather/heavy duty

Lightweight, flexible, easy to store/remove
Impact-resistant
30x more scratch resistance than regular poly windshields

REAR PANEL



LR REAR PANEL - HARD COAT POLY

- Designed with a flat polycarbonate viewing area to maintain rearward visibility
- A thermoformed shroud seals the lower portion of the cab to reduce rear air swirl
- Compatible with all storage and the spare tire carrier

» 2884519
XP/4 '24-25
Not compatible with Rear Speaker Pods (2883945)



POLY

POLY SPORT ROOF

- Durable, lightweight polypropylene with contoured design for water run-off
- Maximum protection with full seal for a leak-free barrier and reduced chatter

COLOR	2-SEAT	4-SEAT <small>NOT SHOWN</small>
■ MATTE BLACK	2884553	2884554
	XP '24-25	XP 4 '24-25

ALUMINUM

- High protection strength
- Lower profile
- Sleek style

VS

POLY

- Water run-off
- Pre-existing mounting features
- Lightweight



ALUMINUM

ALUMINUM ROOF TOP SELLER

- .32 cm lightweight aluminum stamped sheet with full seal for a leak-free barrier and vibration elimination
- Quick install, low-profile design with maximum protection and durability from the harshest conditions

COLOR	2-SEAT	4-SEAT
■ MATTE BLACK	2884549-458	2884551-458
■ INDY RED	2884549-293	2884551-293
	XP '24-25	XP 4 '24-25





> DOORS

- XP
- AUDIO
- WINDSHIELDS & REAR PANELS
- ROPS, DOORS & HEATER
- VEHICLE PROTECTION
- LIGHTING
- STORAGE
- MIRRORS, HARNESSSES & WINCHES
- MAINTENANCE PARTS & FLUIDS



UPPER DOORS

- High quality compression molded doors nest into thermoformed high-density polyethylene side shrouds for excellent sealing
- Includes zip-down 30-gauge clear vinyl windows
- Provides profiled cab edge for superior fit and finish
- Includes external latches

COLOR	2-SEAT	4-SEAT
■ MATTE BLACK	2884533	2884534
	XP '24-25	XP 4 '24-25



EXTERIOR DOOR LATCH KIT

- Makes opening doors from outside the vehicle easier
- Includes one latch per door
- » 2-SEAT • 2889402
XP '24-25
- » 4-SEAT • 2889403 NOT SHOWN
XP 4 '24-25



> HEATER

HEATER KIT

- Connects to Polaris PULSE bus bar and provides reliable, steady heat to your cab with fan speed and temperature control
- Select between in-cab heat, demist vents or both with a controllable knob
- » 2884523
XP/4 '24-25



RZR XP

BUMPERS



LOW PROFILE BUMPER TOP SELLER

• Durable, powder-coated 3.8 cm tube steel with sleek lower profile

COLOR	FRONT	REAR
■ MATTE BLACK	2884515-458 XP/4 *24-25	2884516-458 XP/4 *24-25

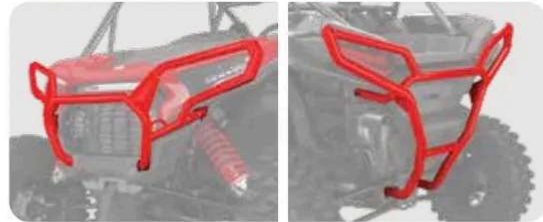

HIGH COVERAGE BUMPER

• Durable 3.8 cm tube steel with headlight bezels for maximum coverage

COLOR	FRONT	REAR
■ MATTE BLACK	2884513-458	2884514-458
■ INDY RED	2884513-293 XP/4 *24-25 NOT COMPATIBLE WITH TRACTOR OR ZUG MODELS	2884514-293 XP/4 *24-25 NOT COMPATIBLE WITH TRACTOR OR ZUG MODELS

NEXT-LEVEL STYLE AND FUNCTION. FRONT BUMPERS ARE DESIGNED TO EFFORTLESSLY INTEGRATE A WINCH OR 15.2 CM RIGID LIGHT BAR



INTEGRATED WINCH

SEE P. 47



RIGID 15.24 CM LIGHT BAR

SEE P. 42



- XP
- AUDIO
- WINDSHIELDS & REAR PANELS
- ROOFS, DOORS & HEATER
- VEHICLE PROTECTION
- LIGHTING
- STORAGE
- MIRRORS, HARNESSSES & WINCHES
- MAINTENANCE PARTS & FLUIDS

ROCK SLIDERS



12-GAUGE STAMPED STEEL
NO LOSS IN GROUND CLEARANCE

LOW PROFILE

COLOR	2-SEAT	4-SEAT
■ MATTE BLACK	2884472-458	2884511-458
■ INDY RED	2884472-293	2884511-293
	XP '24-25	XP 4 '24-25



3.18 cm STEEL TUBE CONSTRUCTION FOR
MAX PROTECTION THROUGH ROUGH TERRAIN

HD EXTREME KICK-OUT

COLOR	2-SEAT	4-SEAT
■ MATTE BLACK	2884473-458	2884512-458
■ INDY RED	2884473-293	2884512-293
	XP '24-25	XP 4 '24-25

SEAMLESS INSTALLATION
Reusable anchors allow for easy installation of rock sliders into the built-in, dedicated chassis location.

CLOSED/UNLOCKED

OPEN/LOCKED

FENDER FLARES & ARM GUARDS



FULL COVERAGE FENDER FLARES

- Replaces stock fender flares and provides additional coverage with factory styling
 - Front and rear included
- » 2889133
XP/4 '24-25
STANDARD ON TRACTOR AND ZUG VERSION



TRAILING ARM GUARDS

- Reliable protection for vital suspension components of your vehicle
 - HDPE poly guard bolts to Trailing Arm Guards to protect against rock abrasions
- » 2889442
XP/4 '24-25



HIGH CLEARANCE SUSPENSION KIT

- Designed to optimize ground clearance
 - Includes one set of high clearance front control arms and high clearance radius rods
- » 2890853
XP/4 '24-25

RZR XP

> LIGHTING



RIGID

ADVANCED TECH

RIGID® lights are driven by Aluminum PCB Smart Boards®, 6063-T5 aircraft aluminum extruded housings and Tiger Drylac® UV protection polyester powdercoating.

EXCLUSIVE OPTICS

RIGID® invests heavily in optical science and has patented multiple optics and optics systems, maximizing light output and efficiency.

LIGHT BAR OPTIONS

1. CHOOSE YOUR LIGHT BAR



BRAND	RIGID
SIZE	15.2 CM
TYPE	DUAL-ROW E-SERIES
RAW LUMENS	9,504
PN	2884649*
FITMENT	XP/4 '24-25

Requires bumper, sold separately.



MOUNTS TO FRONT FASCIA WITH ACCESSORY BUMPER

BRAND	RIGID
SIZE	81.3 CM
TYPE	SR-SERIES
RAW LUMENS	20,064
PN	2884648*
FITMENT	XP/4 '24-25

Requires roof, sold separately.

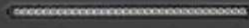

MOUNTS TO ROOF FOR MAXIMUM VISIBILITY

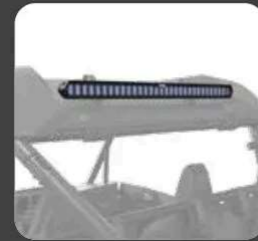

RIGID CHASE LIGHT

- Bright, daylight visible lighting with eleven selectable modes, including white scene lighting for accessing cargo bed in the dark.
 - Connects into brake light system for additional high mount brake light
- » 2884359*
XP/4 '24-25

*Not available in Europe

2. ADD A MOUNT

MOUNT OPTIONS

15.2 CM LIGHT BAR MOUNT

2884510
XP/4 '24-25

81.3 CM LIGHT BAR MOUNT

2884650
XP/4 '24-25

CHASE LIGHT MOUNT KIT

2889121
XP/4 '24-25

3. ADD A HARNESS

HARNESS OPTIONS

MODEL	LIGHT BAR SET-UPS		
	1 LIGHT IN 1 LOCATION ON 1 SWITCH	2 LIGHTS IN 2 LOCATIONS ON 2 SWITCHES	CHASE LIGHT
XP / 4 '24-25	POLARIS PULSE LIGHT BAR HARNESS 2889291	POLARIS PULSE LIGHT BAR HARNESS (X2) 2889291	CHASE LIGHT HARNESS 2889293

**POLARIS ENGINEERED
ADVANTAGES**



PLUG & PLAY ELECTRICAL

POLARIS PULSE IS A REVOLUTIONARY
way to provide power to your vehicle and
makes adding electrical accessories a snap.



ACCENT LIGHT KIT

- Durable construction resists dust and water while on the trails
 - Front and rear LED accent lights
- » 2889539
XP/4 24-25
STANDARD ON ULTIMATE MODELS
NOT AVAILABLE IN EUROPE



- XP
- AUDIO
- WINDSHIELDS & REAR PANELS
- ROOFS, DOORS & HEATER
- VEHICLE PROTECTION
- LIGHTING
- STORAGE
- MIRRORS, HARNESSSES & WINCHES
- MAINTENANCE PARTS & FLUIDS

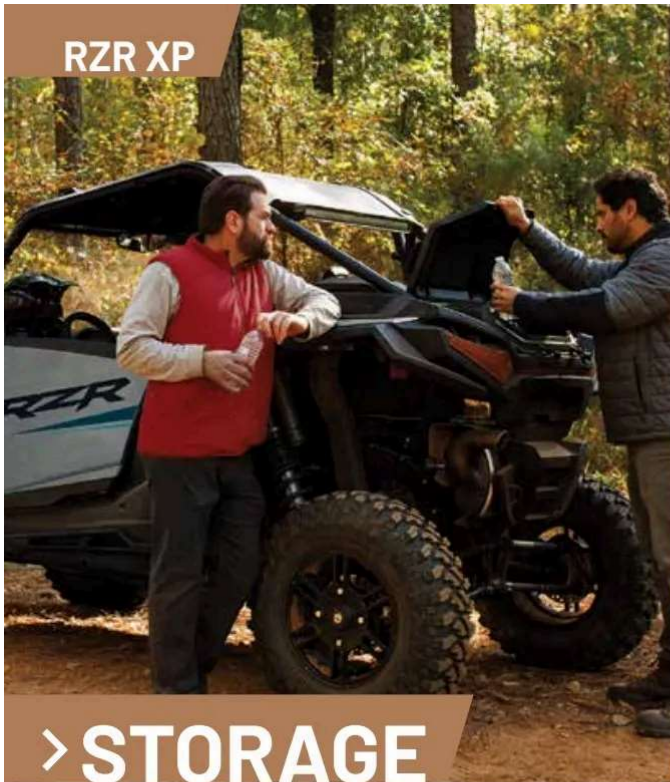

RZR XP



> STORAGE



78 L FORWARD CARGO BOX

- Easy-to-use latches and molded side handles
- Durable polypropylene, engineered to seal out dust and water
- Lock & Ride strongly secures the box to the cargo bed

» 2889611
XP/4 '24-25



Fit: 2 Full-Size Helmets | Tool Kit | Jacket/Coat | Food & Drinks

FORWARD CARGO BOX NESTS PERFECTLY TOGETHER WITH REAR CARGO BOX OR 28 L REAR COOLER



52 L REAR CARGO BOX

- Easy-to-use latches and molded side handles
- Durable polypropylene, engineered to seal out dust and water
- Lock & Ride strongly secures the box to the cargo bed

» 2884525
XP/4 '24-25

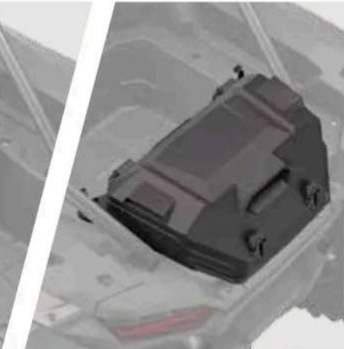

Fit: Jacket/Coat | First Aid Kit | Snacks | Sunscreen

REAR CARGO BOX NESTS PERFECTLY TOGETHER WITH 28 L NORTHSTAR COOLER OR FORWARD CARGO BOX



Fit: Flashlight | Snacks | Sunglasses | Bug Spray

8 L SHOULDER STORAGE BAG

- Keeps your belongings safe and secure
- Molded sides and lid with dual YKK® zippers
- Easy install and quick access with a sleek cockpit look

» 2884530
XP/4 '24-25
Fits between rear seats on 4-Seat models

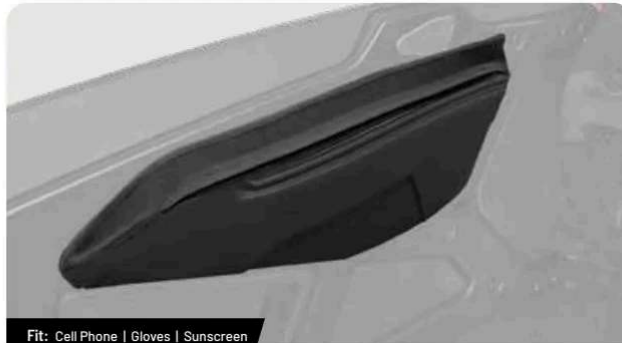

Fit: Cell Phone | Gloves | Sunscreen

4.7 L DOOR STORAGE BAG

- Quick reach access to keep supplies and gear secure
- Waterproof YKK® zippers keep everything enclosed, clean and dry

» 2884528
XP/4 '24-25
Compatible with front doors only



- XP
- AUDIO
- WINDSHIELDS & REAR PANELS
- ROOFS, DOORS & HEATER



26 L REAR COOLER

- Lid locks securely in place with rubber latches to protect cargo
- Provides plenty of storage without weighing you down
- Keeps your food, beverages and bait fresh while out on the trails
- Nests with forward cargo box

» 2889612
XP/4 '24-25



POLARIS NORTHSTAR 28 L COOLER

- Nests with rear cargo box
- » GRAPHITE • 2883424
- » SAGEBRUSH GREEN • 2890706

XP/4 '24-25



NORTHSTAR 28 L COOLER BRACKET

» 2884526
XP/4 '24-25

SEE P. 72 FOR FULL DETAILS ON POLARIS NORTHSTAR COOLERS

- VEHICLE PROTECTION

- LIGHTING

- STORAGE



TONNEAU COVER TOPSELLER

- One cover seals the entire storage box
- Built-in friction hinge to stay open on its own

» 2884548
XP/4 '24-25

Not compatible with cargo boxes or coolers



PIVOTING SPARE TIRE CARRIER

- Secure mounting with dual latches and single-handed release mechanism
- Steel mounts and rack
- Holds up to a 32" tire and supports 34 kg of weight

» 2884546-458
XP/4 '24-25

- MIRRORS, HARNESSSES & WINCHES

- MAINTENANCE PARTS & FLUIDS

SEE COVERS AND STRAPS P. 82

RZR XP



> MIRRORS



ADJUSTABLE FOLDING SIDE MIRRORS

- Left and right mirrors included
- Installs in minutes and integrates into a designated mounting position
- Laminated safety glass for excellent scratch resistance

» 2884524
XP / 4 '24-25



PREMIUM CONVEX REARVIEW MIRROR TOP SELLER

- Installs in minutes and integrates into a designated mounting position
- Laminated safety glass for excellent scratch resistance

» 2883763
XP / 4 '24-25

> HARNESSSES

US MODELS ONLY - NOT AVAILABLE IN EUROPE



CLICK6 HARNESS

- Racing-quality, premium construction for increased security
- Six straps with retractable shoulder straps to hold a rider securely in place
- One-click, quick-release buckle releases straps, allowing easy egress
- Fully adjustable to fit riders of all sizes
- Easy to buckle and adjust, even while wearing helmet and gloves

2-SEAT
» 2890046
XP '24-25

4-SEAT
» FRONT • 2890048
XP 4 '24-25
» REAR • 2890049
XP 4 '24-25



RZR SUB ZERO 4-PT HARNESS

- Four straps hold a driver securely in place
- One-click, quick-release buckle releases straps, allowing for easy egress
- Easy to buckle and adjust

2-SEAT
» 2890047
XP '24-25

4-SEAT
» FRONT • 2890050
XP 4 '24-25
» REAR • 2890051
XP 4 '24-25



> WINCHES



- XP
- AUDIO
- WINDSHIELDS & REAR PANELS
- ROOFS, DOORS & HEATER
- VEHICLE PROTECTION
- LIGHTING
- STORAGE
- MIRRORS, HARNESSES & WINCHES
- MAINTENANCE PARTS & FLUIDS

FEATURES	PRO HD SERIES	HD SERIES
RAPID ROPE RECOVERY	STANDARD	NOT AVAILABLE
AUTO STOP TECHNOLOGY	STANDARD	OPTION
WINCH LINE	SYNTHETIC ROPE	SYNTHETIC ROPE
CONTROL	WIRED TOGGLE SWITCH & WIRELESS REMOTE STANDARD	WIRED TOGGLE SWITCH STANDARD, WIRED & WIRELESS REMOTE OPTIONAL
MODEL	2,041 kg	2,041 kg
XP / 4 '24-25	2884836	2884835

REPLACEMENT PARTS

15 M SYNTHETIC ROPE

2,041 kg SERIES
 > 2879187



UPGRADE YOUR HD WINCH

AUTO STOP UPGRADE

- Replaces stock fairlead
- > 2889028
- Synthetic Rope & Wireless Remote (2889561), required

WIRED REMOTE CONTROL

- 1.8 m corded remote
- Direct plug & play operation
- > 2889562



WIRELESS REMOTE

- Up to 15 m range with LED indicator
- Direct plug & play operation
- > 2889561



SEE ADDITIONAL WINCH INFORMATION P. 66

RZR XP

MAINTENANCE PARTS & FLUIDS



POLARIS ENGINEERED PARTS AND OIL have been validated and tested extensively, specifically for your vehicle. In order to maintain the peak performance of your Polaris vehicle only use official Polaris Engineered parts and oil.



We're taking the passion of our riders, workers, and outdoor enthusiasts to the next level with HD Parts. These Heavy Duty parts are engineered for riders who want greater durability and enhanced performance. HD Parts are designed and tested to handle greater wear and tear under all weather conditions.



A DRIVE BELT
» 3211186



B BRAKE PADS
» FRONT • 2211845
» FRONT • **HD** • 2211912
» REAR • 2211852
» REAR • **HD** • 2208933



C OIL FILTER
» 2540086
» **HD** • 2522485



D BATTERY
» 4018054



E AIR FILTER
» 1241084



F SPARK PLUGS
» 3022662



LOOKING FOR MORE SERVICE PARTS?

See P. 95 to learn how to find parts for your model.

MAINTENANCE SCHEDULE*

BREAK-IN MAINTENANCE

- FIRST 25 HRS | 500 MI / 800 KM
- ENGINE OIL & OIL FILTER**
CHANGE
- GENERAL LUBRICATION**
ALL FITTINGS, PIVOTS, CABLES, ETC.
- FRONT GEARCASE / TRANSMISSION**
CHANGE FLUID / INSPECT FLUID
NA / ADD AS NEEDED
- DRIVE BELT**
INSPECT & ADJUST
REPLACE AS NEEDED
- BRAKE PAD / BRAKE FLUID**
INSPECT
REPLACE AS NEEDED / ADD AS NEEDED
- BATTERY**
TEST & CLEAN
REPLACE AS NEEDED

6 MONTHS

- 25 HRS | 500 MI / 800 KM
- AIR FILTER**
INSPECT
REPLACE AS NEEDED
- BRAKE PADS**
INSPECT
REPLACE AS NEEDED
- GENERAL LUBRICATION**
ALL FITTINGS, PIVOTS, CABLES, ETC.
- BATTERY**
TEST & CLEAN
REPLACE AS NEEDED

12 MONTHS

- 50 HRS | 1,000 MI / 1,600 KM
- ENGINE OIL & OIL FILTER**
CHANGE
- BRAKE PAD / BRAKE FLUID**
INSPECT
REPLACE AS NEEDED / ADD AS NEEDED
- GENERAL LUBRICATION**
ALL FITTINGS, PIVOTS, CABLES, ETC.
- DRIVE BELT**
INSPECT & ADJUST
REPLACE AS NEEDED
- FRONT GEARCASE & TRANSMISSION**
CHANGE FLUID
- AIR FILTER / SPARK PLUGS**
INSPECT
REPLACE AS NEEDED
- BATTERY**
TEST & CLEAN
REPLACE AS NEEDED

18 MONTHS

- 150 HRS | 1,500 MI / 2,400 KM
- AIR FILTER**
INSPECT
REPLACE AS NEEDED
- BRAKE PADS**
INSPECT
REPLACE AS NEEDED
- GENERAL LUBRICATION**
ALL FITTINGS, PIVOTS, CABLES, ETC.
- BATTERY**
TEST & CLEAN
REPLACE AS NEEDED



MAINTENANCE MADE EASY



OIL CHANGE KITS

3 L Engine Oil & 1 Oil Filter
(2540086)
» PS-4 • 502543



ALL-SEASON GREASE TUBE

» 400 G • 502538



G ENGINE OIL P. 84

- » PS-4 • 1 L • 502484
- » PS-4 • 4 L • 502485
- » PS-4 EXTREME • 1 L • 503220
- » PS-4 EXTREME • 4 L • 503221



H DEMAND DRIVE FLUID

- Front front gearcase
- » 1 L • 502563
 - » 25 L • 502564
 - » 200 L • 502565



I AGL

- For transmission
- » 1 L • 502505
 - » 25 L • 502507
 - » 200 L • 502508



J DOT 4 BRAKE FLUID

- » 250 ML • 502526

Claims made based off testing and performance of Polaris HD Parts against standard OEM parts made by Polaris and competitor brands under normal use. For more information regarding Polaris HD parts including vehicle compatibility, installation and maintenance, please contact your authorized Polaris ORV dealer

24 MONTHS

200 HRS | 2,000 MI / 3,200 KM

ENGINE OIL & OIL FILTER CHANGE

BRAKE PAD / BRAKE FLUID INSPECT / REPLACE
REPLACE AS NEEDED / REPLACE

GENERAL LUBRICATION
ALL FITTINGS, PIVOTS, CABLES, ETC.

DRIVE BELT INSPECT & ADJUST
REPLACE AS NEEDED

FRONT GEARCASE & TRANSMISSION CHANGE FLUID

AIR FILTER / SPARK PLUGS INSPECT
REPLACE AS NEEDED

BATTERY TEST & CLEAN
REPLACE AS NEEDED

30 MONTHS

250 HRS | 2,500 MI / 4,000 KM

AIR FILTER INSPECT
REPLACE AS NEEDED

BRAKE PADS INSPECT
REPLACE AS NEEDED

GENERAL LUBRICATION
ALL FITTINGS, PIVOTS, CABLES, ETC.

BATTERY TEST & CLEAN
REPLACE AS NEEDED

36 MONTHS

300 HRS | 3,000 MI / 4,800 KM

ENGINE OIL & OIL FILTER CHANGE

BRAKE PAD / BRAKE FLUID INSPECT
REPLACE AS NEEDED / ADD AS NEEDED

GENERAL LUBRICATION
ALL FITTINGS, PIVOTS, CABLES, ETC.

DRIVE BELT INSPECT & ADJUST
REPLACE AS NEEDED

FRONT GEARCASE & TRANSMISSION CHANGE FLUID

AIR FILTER / SPARK PLUGS INSPECT
REPLACE AS NEEDED

BATTERY TEST & CLEAN
REPLACE AS NEEDED

FOR A COMPLETE MAINTENANCE SCHEDULE, CHECK YOUR OWNER'S MANUAL

*This is a sample maintenance schedule. Please reference and use your owners manual for full maintenance and vehicle care.

XP

AUDIO

WINDSHIELDS & REAR PANELS

ROOFS, DOORS & HEATER

VEHICLE PROTECTION

LIGHTING

STORAGE

MIRRORS, HARNESSSES & WINCHES

MAINTENANCE PARTS & FLUIDS

RZR TRAIL S

POLARIS
RZR TRAIL



► EXPLORER PACKAGE

2889537	Tip Out Windshield - Hard Coat Poly: P. 53	2884871	Accent Lights*: P. 60
2884729	 Poly Sport Roof: P. 54	2883763	Premium Convex Rearview Mirror: P. 61
2884912	Stage 1 PMX Audio Kit by Rockford Fosgate®: P. 55	2884524	Adjustable Folding Side Mirrors: P. 61
2883945	Rear Speaker Pods by Rockford Fosgate®: P. 55	2883123	RIGID SR-Series 25.4 cm Combo LED Light: P. 69
2415652	Rear Speaker Pod Audio Harness: P. 55	2884657	Light Bar Harness: P. 69
2884732-458	Front High Coverage Bumper: P. 56	5416340	Pro Armor Spare Tire: Dual Threat, 26" **: P. 76
2884734-458	Rear Bumper Extension*: P. 56	1523283	Pro Armor Spare Wheel: 4301 Beadlock, 14": P. 79
2884762	Spare Tire Carrier: P. 57	2883216	Pro Armor Wheel & Tire Set: 4301 Beadlock & Dual Threat, 26" **: P. 80

Shown on Trail. Applicable to all models with adjustments.

*Not available in Europe

**May widen vehicle beyond 50".

> TRAILBLAZER PACKAGE





- 2884911  Full Vented Windshield - Hard Coat Poly: P. 53
- 2884765  Poly Rear Panel*: P. 53
- 2884761-458 Aluminum Roof: P. 54
- 2884868-458 Front Winch Bumper: P. 56
- 2884734-458 Rear Bumper Extension*: P. 56
- 2879456-458 Extreme Kick-Out Rock Sliders: P. 56
- 2881985 Full Coverage Fender Flares: P. 56
- 2881193  65 L Cargo Box : P. 57
- 2885126 Polaris Pro HD 2,042 kg Winch: P. 58
- 2883763 Premium Convex Rearview Mirror: P. 61
- 2884524 Adjustable Folding Side Mirrors: P. 61
- 2879332 12MM x 1.5 Splined Lug Nuts with Wrench Adapter: P. 78
- 2883157 Pro Armor Wheel & Tire Set: 5202 & Attack 2.0, 28": P. 80

Shown on Trail S. Applicable to all models with adjustments.
*Not available in Europe

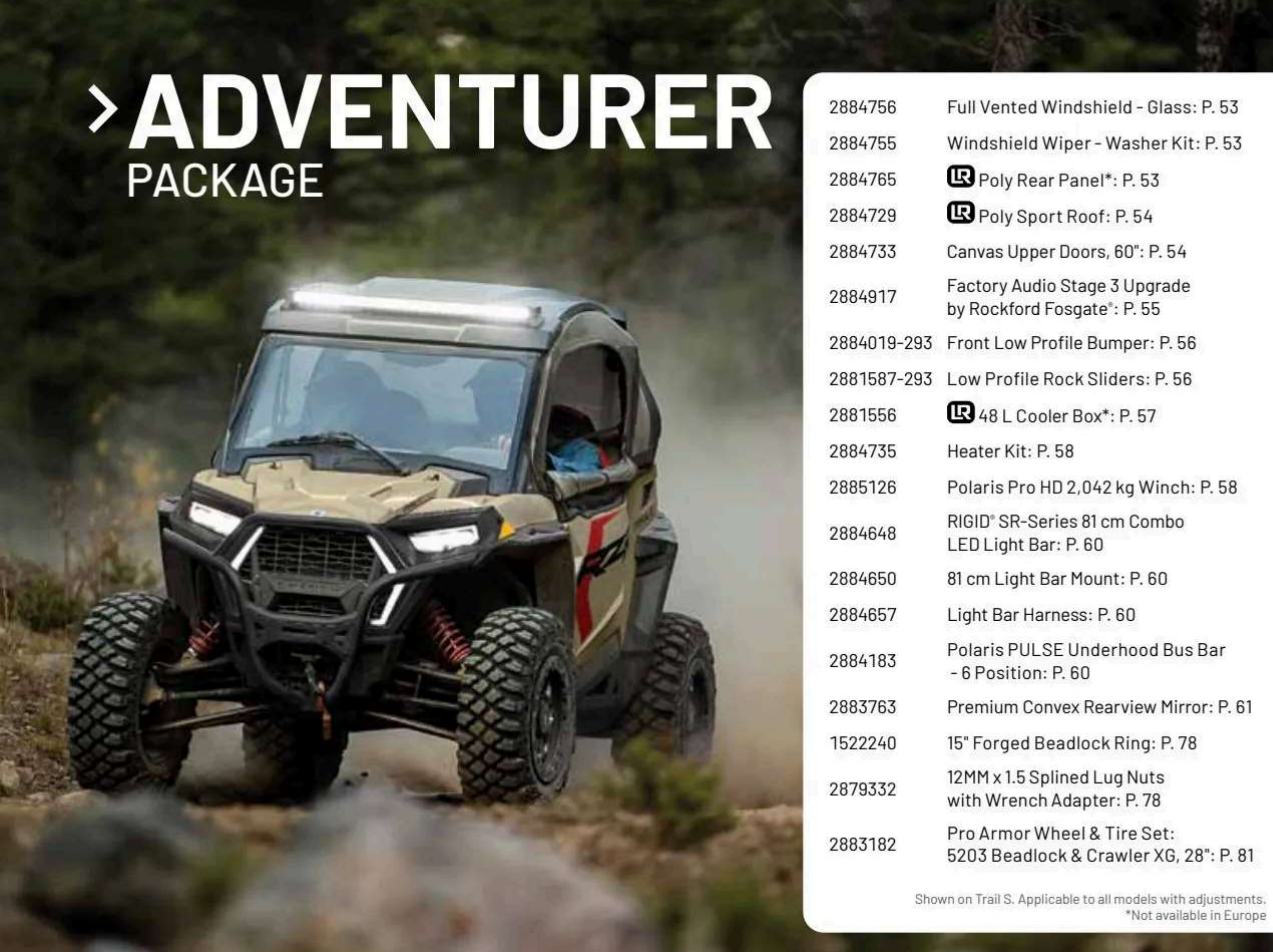
> ADVENTURER PACKAGE



- 2884756 Full Vented Windshield - Glass: P. 53
- 2884755 Windshield Wiper - Washer Kit: P. 53
- 2884765  Poly Rear Panel*: P. 53
- 2884729  Poly Sport Roof: P. 54
- 2884733 Canvas Upper Doors, 60": P. 54
- 2884917 Factory Audio Stage 3 Upgrade by Rockford Fosgate*: P. 55
- 2884019-293 Front Low Profile Bumper: P. 56
- 2881587-293 Low Profile Rock Sliders: P. 56
- 2881556  48 L Cooler Box*: P. 57
- 2884735 Heater Kit: P. 58
- 2885126 Polaris Pro HD 2,042 kg Winch: P. 58
- 2884648 RIGID® SR-Series 81 cm Combo LED Light Bar: P. 60
- 2884650 81 cm Light Bar Mount: P. 60
- 2884657 Light Bar Harness: P. 60
- 2884183 Polaris PULSE Underhood Bus Bar - 6 Position: P. 60
- 2883763 Premium Convex Rearview Mirror: P. 61
- 1522240 15" Forged Beadlock Ring: P. 78
- 2879332 12MM x 1.5 Splined Lug Nuts with Wrench Adapter: P. 78
- 2883182 Pro Armor Wheel & Tire Set: 5203 Beadlock & Crawler XG, 28": P. 81

Shown on Trail S. Applicable to all models with adjustments.
*Not available in Europe

RZR TRAILS



> BUILD YOUR CAB

ADD COMFORT AND STYLE WITH END-TO-END PROTECTION



ADD A WINDSHIELD
Protect yourself and your passenger with optical clarity.

ADD A ROOF
Shield from harsh elements while adding style.

ADD A REAR PANEL
Maintain rear visibility while reducing rear air swirl.

ADD DOORS
Keep the cab free of dust and water.

RECOMMENDED BUILD 1

- 2889537 • Tip Out Windshield - Hard Coat Poly
- 2884765 • Poly Rear Panel*
- 2884761-458 • Aluminum Roof

RECOMMENDED BUILD 2

- 2884756 • Full Vented Windshield - Glass
- 2884755 • Windshield Wiper - Washer Kit
- 2884765 • Poly Rear Panel*
- 2884729 • Poly Sport Roof



LOCK & RIDE

REVOLUTIONARY INSTALLATION

Lock & Ride clamps make for easy on-off and eliminate the risk of cracking.



POLARIS ENGINEERED ADVANTAGES

GASKETED SEAL

Keeps drafts and moisture out. Reduces ride chatter on full glass windshields.

WINDSHIELDS

GLASS



FULL VENTED WINDSHIELD - GLASS

- Double layer laminated, tempered glass windshield with steel powder-coated frame and center adjustable vent

» 2884756

TRAIL S '21-25, TRAIL '21-25

HARD COAT POLY

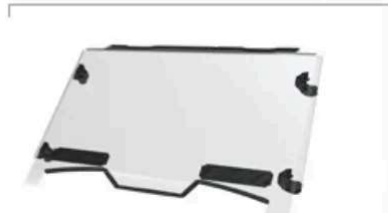

FULL VENTED WINDSHIELD - HARD COAT POLY

- Impact-resistant, long-lasting .64 cm durable hard coated polycarbonate
- Full protection with airflow vents that quickly open for cockpit ventilation

» 2884911

TRAIL S '21-25, TRAIL '21-25



TIP OUT WINDSHIELD - HARD COAT POLY

- Hard coated polycarbonate panel windshield that offers three positions: closed, vented and full open
- Single-handed latch with gas support struts

» 2889537

TRAIL S '21-25, TRAIL '21-25



WINDSHIELD WIPER - WASHER KIT

- Simple to control, featuring a multi-speed dash-mounted rocker switch
- Includes a washer fluid reservoir

» 2884755

TRAIL S '21-25, TRAIL '21-25

Compatible with glass windshield only

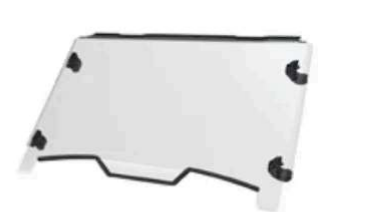

FULL WINDSHIELD - HARD COAT POLY

- Impact-resistant, long-lasting .64 cm durable hard coated polycarbonate
- No frame design offers maximum visibility
- Integrates with all cab components

» 2884757

TRAIL S '21-25, TRAIL '21-25



HALF WINDSHIELD - HARD COAT POLY TOP SELLER

- Impact-resistant, long-lasting .64 cm durable hard coated polycarbonate
- Provides protection and airflow into the cab
- 17.8 cm tall

» 2884768

TRAIL S '21-25, TRAIL '21-25

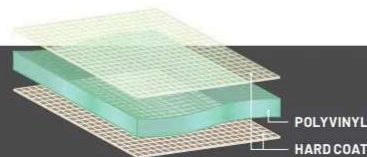
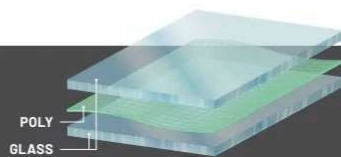

GLASS VS HARD COAT POLY

Superior optical clarity (automotive level)
 Scratch-resistant
 Seals tight
 Cold weather/heavy duty

Lightweight, flexible, easy to store/remove
 Impact-resistant
 30x more scratch resistance than regular poly windshields

REAR PANEL

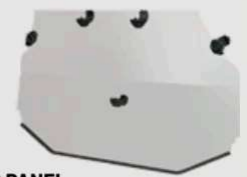

POLY REAR PANEL

- Maintains rear visibility and reduces rear air swirl from entering the cockpit
- Fully compatible with all accessories
- If installed, Rear Audio Pods should project backwards

» 2884765

TRAIL S '21-25, TRAIL '21-25
 U.S. MODELS ONLY.

RZR TRAIL S



> ROOFS

ALUMINUM VS POLY

High protection strength
Lower profile
Sleek style

Water run-off
Pre-existing mounting features
Lightweight

ALUMINUM

ALUMINUM ROOF TOP SELLER

- Seals to the roll cage for the best protection, while seamlessly integrating with other RZR accessories
- Strong and durable aluminum construction for long-lasting, reliable protection

COLOR	PART NUMBER
■ MATTE BLACK	2884761-458
■ INDY RED	2884761-293

TRAIL S '21-25, TRAIL '21-25



POLY

LR POLY SPORT ROOF

- Rigid, injection-molded design to eliminate warping in high-heat conditions
- Integrated mounting locations for lighting
- Rugged, textured polyethylene construction for impact and abrasion resistance

COLOR	PART NUMBER
■ MATTE BLACK	2884729

TRAIL S '21-25, TRAIL '21-25
STANDARD ON ULTIMATE TRIM

> DOORS



CANVAS UPPER DOORS

- Pre-loaded tubular aluminum frame provides a tight seal along the roll cage
- Zip-down vinyl windows offer increased comfort in warmer conditions
- Zippered access ports for easy ingress and egress

» 60" • 2884733

TRAIL S '21-25

» 50" • 2884758 NOT SHOWN

TRAIL '21-25

ALUMINUM LOWER HALF DOORS

- Single-piece stamped aluminum maximizes quality, fit and finish
- Gasket design eliminates rattling and creates a firm seal

» 2879510

TRAIL S '21-25

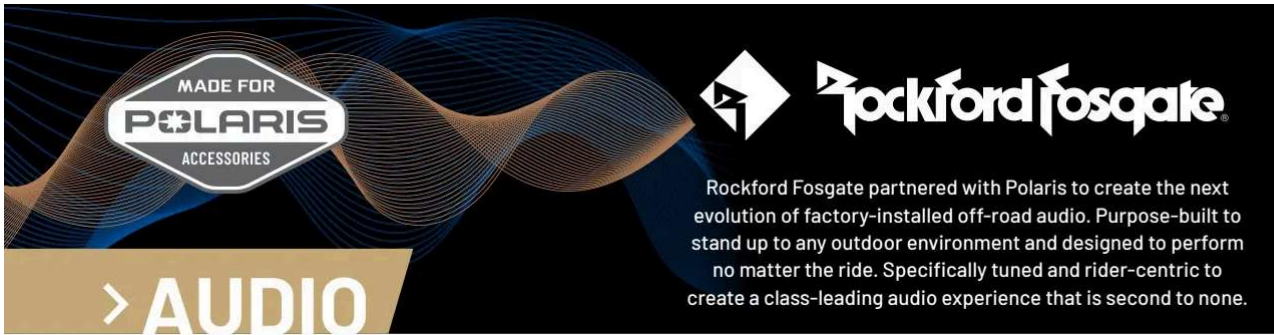

TRAIL ACCESSORIES

WINDSHIELDS & REAR PANELS

ROOFS, DOORS & AUDIO

VEHICLE PROTECTION & STORAGE

WINCHES, HEATER & FLUIDS

LIGHTING & ELECTRICAL

HARNESSES, MIRRORS & TRACKS

MAINTENANCE PARTS & FLUIDS

BUILD YOUR SOUND

STEP 1

SELECT HEAD UNIT & ADD AUDIO

7" DISPLAY POWERED BY RIDE COMMAND

2884072

TRAIL S '22-25

MOUNT KIT REQUIRED

2884731

TRAIL S '22-25

SEE P. 70 FOR FULL RIDE COMMAND DETAILS

OR

STAGE 1 PMX AUDIO KIT

2884912

TRAIL S '21-25, TRAIL '21-25

MOUNT KIT INCLUDED

+

STAGE 3 RIDE COMMAND AUDIO KIT

2884914

TRAIL S '22-25

STEP 2

UPGRADE AUDIO

REAR SPEAKER PODS

2883945

TRAIL S '21-25, TRAIL '21-25

REAR SPEAKER POD AUDIO HARNESS

2415652

TRAIL S '21-25, TRAIL '21-25

REQUIRED TO ADD PODS TO STAGE 1 OR STAGE 3



7" DISPLAY POWERED BY RIDE COMMAND

» 2884072

TRAIL S '22-25

STANDARD ON ULTIMATE MODELS

Requires Mount Kit (2884731)

SEE P. 70 FOR FULL RIDE COMMAND DETAILS



STAGE 1 PMX AUDIO KIT

- 6.86 cm full color display
- AM/FM/WB tuner w/ antenna*
- Bluetooth connectivity
- Includes mount kit
- Two front 16.5 cm coaxial speakers with enclosures

» 2884912

TRAIL S '21-25, TRAIL '21-25

NOT COMPATIBLE WITH ULTIMATE TRIM



STAGE 3 RIDE COMMAND AUDIO KIT

FRONT SPEAKERS & SUBWOOFER

- 200 watt 25.4 cm subwoofer with enclosure
- 400 watt full range amplifier
- Two 50 watt 16.51 cm component speakers with enclosures

» 2884914

TRAIL S '22-25

NOT COMPATIBLE WITH ULTIMATE TRIM or Stage 1 PMX Audio Kit



REAR SPEAKER PODS

USE WITH STAGE 1 OR STAGE 3

- 50 watt 16.51 cm coaxial speakers with can-enclosures, mounting hardware and grilles
- Audio Harness (2415652) required, sold separately

» 2883945

TRAIL S '21-25, TRAIL '21-25

*The FM Frequency range is from 88 to 108 and only on the odds (i.e. 88.1, 88.3, etc.).



RZR TRAIL S

> VEHICLE PROTECTION

BUMPERS & FENDER FLARES



FRONT HIGH COVERAGE BUMPER

- Durable, powder-coated 4.45 cm tube steel with sleek profile for full coverage with headlight protection
- Does not cover Accent Lights

COLOR	PART NUMBER
■ MATTE BLACK	2884732-458
■ INDY RED	2884732-293

TRAIL S '21-25, TRAIL '21-25
Not compatible with Glacier Pro Plow Mount (2884764)



FRONT LOW PROFILE BUMPER

- **TOP SELLER**
- 4.45 cm powder-coated steel tubing provides impact protection and aggressive styling

COLOR	PART NUMBER
■ MATTE BLACK	2884019-458
■ INDY RED	2884019-293

TRAIL S '21-25, TRAIL '21-25



FRONT WINCH BUMPER

- Elevated mounting location on bumper for easy access to 2.041 kg Winch
- Requires winch (2885127, 2885126), sold separately

COLOR	PART NUMBER
■ MATTE BLACK	2884868-458

TRAIL S '21-25, TRAIL '21-25



REAR BUMPER EXTENSION

- Bumper extension quickly attaches to rear ROPS to provide additional taillight protection

COLOR	PART NUMBER
■ MATTE BLACK	2884734-458

TRAIL S '21-25, TRAIL '21-25
(U.S. MODELS ONLY)



REAR DELUXE BUMPER

- Rear bumper extension expressly developed for EU-Models

COLOR	PART NUMBER
■ MATTE BLACK	2880164-458

TRAIL S '21-25 EU MODEL



152.4 cm STYLE FENDER FLARES

- Stock replacement for Trail S
- Includes four, front and rear
- » 2879434

TRAIL S '21-25, TRAIL '21-25



FULL COVERAGE FENDER FLARES

- Help keep mud and dirt from launching off the tires and into the vehicle
- Includes two, front only
- » 2881985

TRAIL S '21-25, TRAIL '21-25

ROCK SLIDERS



10-GAUGE STAMPED STEEL
NO LOSS IN GROUND CLEARANCE

LOW PROFILE

COLOR	PART NUMBER
■ MATTE BLACK	2879498-458
■ INDY RED	2881587-293

TRAIL S '21-25, TRAIL '21-25



4.5 cm STEEL TUBE CONSTRUCTION
EXTENDS FROM MACHINE FOR
MAX PROTECTION THROUGH ROUGH TERRAIN

EXTREME KICK-OUT

COLOR	PART NUMBER
■ MATTE BLACK	2879456-458
■ INDY RED	2881586-293

TRAIL S '21-25, TRAIL '21-25

ANCHOR MOUNTS

Tougher than conventional nuts and bolts, Expansion Anchor Mounts are engineered into every RZR, allowing for a fast install.

BUMPER ANCHOR PACK

- Four anchors and two bumper end caps included
- » 2205114



UNEXPANDED EXPANDED



> STORAGE

- TRAIL ACCESSORIES
- WINDSHIELDS & REAR PANELS
- ROOF DOORS & AUDIO
- VEHICLE PROTECTION & STORAGE
- WINCHES, HEATER & FLUIDS
- LIGHTING & ELECTRICAL
- HARNESSES, MIRRORS & TRACKS
- MAINTENANCE PARTS & FLUIDS



LR
48 L COOLER BOX

- One-piece, rotomolded construction for extreme durability
- Lid locks securely in place with rubber latches to protect cargo
- Heavy-duty hinges and weatherproof seal block moisture and dust
- Keeps food and beverages cool for 48+ hours, depending on conditions
- UV-fade resistant
- Installs quickly and easily without tools
- Easy to carry with integrated grab handles

» 2881556
TRAIL S '21-25, TRAIL '21-25
(U.S. MODELS ONLY)



LR
65 L CARGO BOX TOP SELLER

- Integrated rear cargo box, touting 65 L of storage
- Secure latching lid with taut rubber strap tie-downs
- Lightweight design integrates seamlessly into the rear cargo bed
- Includes all mounting hardware for complete installation

» 2881193
TRAIL S '21-25, TRAIL '21-25



SPARE TIRE CARRIER

- Mounts to rear ROPS to keep cargo bed free
- Compatible with Rear Bumper Extension (2884734-458)
- Quick installation

» 2884762
TRAIL S '21-25, TRAIL '21-25
(U.S. MODELS ONLY)

BED D-RINGS

» 2877460
TRAIL S '21-25, TRAIL '21-25

LR
D-RINGS

» 2881544
TRAIL S '21-25, TRAIL '21-25



RZR TRAILS

> WINCHES



FEATURES	PRO HD SERIES	HD SERIES	
RAPID ROPE RECOVERY	STANDARD	NOT AVAILABLE	
AUTO STOP TECHNOLOGY	STANDARD	OPTION	
WINCH LINE	SYNTHETIC ROPE	STEEL CABLE	
CONTROL	WIRELESS & WIRED STANDARD	WIRED STANDARD, WIRELESS OPTION	
MODEL	2,041 kg	1,588 kg	ADD REQUIRED CABLES
TRAIL S '21-25 TRAIL '21-25	2885126	2885127	WINCH COVER KIT REQUIRED 2884118 TRAIL S '21-25, TRAIL '21-25

REPLACEMENT PARTS



15 M SYNTHETIC ROPE
2,041 kg SERIES
» 2879187



15 M STEEL CABLE
1,588 kg SERIES
» 2878890

UPGRADE YOUR HD WINCH

WIRELESS REMOTE

- Up to 15 m range with LED indicator
- Direct plug & play operation

» 2879316



AUTO STOP UPGRADE

- Billet aluminum
- Replaces stock fairlead

» 2881693
Synthetic Rope required

> HEATER



HEATER KIT

- Connects to Polaris PULSE Bus Bar to provide reliable, steady heat to your cab with fan speed and temperature control
 - Selectable vent positions include driver/passenger, defrost or a combination of both
 - Includes two defrost vents and two cabin vents
 - Compatible with subwoofer upgrade
- » 2884735
TRAIL S '21-25, TRAIL '21-25



> PLOWS

GLACIER PLOW SYSTEMS

MAKE QUICK WORK OF SMALLER JOBS

Move snow with the tough and capable Glacier Pro HD Plow System and discover why a major snowfall can be the highlight of your week. With a robust frame, beefy poly and steel blade options, dismounting and amazing value, Glacier Pro HD is a great choice in the dead of winter.

168 cm BLADES

CHOICE OF POLY OR STEEL

MANUAL ANGLE SYSTEM STANDARD

LR

43 cm

168 cm POLY BLADE
Best for corrosion resistance

43 cm

168 cm STEEL BLADE
Best for big jobs year after year

BUILD A PLOW SYSTEM					
	STEP 1 SELECT A MOUNT	STEP 2 SELECT A FRAME	STEP 3 SELECT A LIFT METHOD	STEP 4 SELECT A BLADE	STEP 5 SELECT ACCESSORIES
MODELS	MOUNT	FRAME	WINCH	BLADES	ACCESSORIES
Trail S '21-25 Trail '21-25	Glacier Pro Plow Mount 2884764	Glacier Pro HD Push Frame 2880260	<p>Polaris Pro HD 2,041 kg Winch with Rapid Rope Recovery See P. 58 for details</p> <p>Polaris HD 1,588 kg Winch See P. 58 for details</p>	<p>Glacier Pro Plow Blade 168 cm Poly 2880269</p> <p>Glacier Pro Plow Blade 168 cm Steel 2880268</p>	<p>168 cm Snow Deflector 2879866</p> <p>168 cm HD Wear Bar 2879868</p> <p>168 cm Wear Bar 2879867</p> <p>Plow Marker 2872726</p> <p>Skid Shoe 2208864</p> <p>Shear Pin 2205527</p> <p>Plow Extension 2880267</p>

RZR TRAIL S



> LIGHTING & ELECTRICAL



RIGID SR-SERIES 81 CM COMBO LED LIGHT BAR

- » LIGHT BAR 2884648
 - » MOUNT (REQUIRED) 2884650
 - » HARNESS (REQUIRED) 2884657
- TRAIL S '21-25, TRAIL '21-25 NOT AVAILABLE IN EUROPE

ADDITIONAL LIGHTING OPTIONS
SEE P. 68



ACCENT LIGHTS TOP SELLER

- Includes a pair of front fascia accent lights
 - Durable dust and waterproof construction
- » 2884871
- TRAIL S '21-25, TRAIL '21-25 NOT AVAILABLE IN EUROPE



PLUG & PLAY ELECTRICAL

POLARIS PULSE IS A REVOLUTIONARY way to provide power to your vehicle, and makes adding electrical accessories a snap.



POLARIS PULSE UNDERHOOD BUS BAR - 6 POSITION

- If upgrading to have more than three accessories attaching to the underhood PULSE location, replace the 3 Position Bus Bar with the 6 Position Bus Bar
- » 2884183
- TRAIL S '21-25, TRAIL '21-25

> HARNESSES & MIRRORS



RZR SUB ZERO 4-PT HARNESS TOP SELLER

- Four straps hold a driver securely in place
- One-click, quick-release buckle releases straps, allowing for easy egress
- Easy to buckle and adjust
- » DRIVER SIDE • 2890265
TRAIL S '21-25, TRAIL '21-25
US MODELS ONLY - NOT AVAILABLE IN EUROPE
- » PASSENGER SIDE • 2890266
TRAIL S '21-25, TRAIL '21-25
US MODELS ONLY - NOT AVAILABLE IN EUROPE



ADJUSTABLE FOLDING SIDE MIRRORS

- Left and right mirrors included
- Installs in minutes and integrates into a designed mounting position
- Laminated safety glass for excellent scratch resistance
- » 2884524
TRAIL S '21-25, TRAIL '21-25



PREMIUM CONVEX REARVIEW MIRROR TOP SELLER

- Installs in minutes and integrates into a designated mounting position
- Laminated safety glass for excellent scratch resistance
- » 2883763
TRAIL S '21-25, TRAIL '21-25



> TRACKS



PROSPECTOR PRO 2.0 TRACK SYSTEM

TRACKS

- » 2889487
TRAIL S '21-25, TRAIL '21-25
COMPATIBLE WITH PREMIUM/ULTIMATE ONLY
Plow Extension (2880267) required for using a plow with tracks
Only compatible with Glacier Pro HD System

MOUNTS

- » 50" MODELS 2880648
TRAIL '21-25
- » 60" MODELS 2880649
TRAIL S '21-25

1 INDUSTRY-FIRST FLEX-TRACK DESIGN
Front-mounted tracks with flexible sides and a slight inward curve allow for stable handling, a more comfortable ride and precise steering over long-distances or extended working hours.

2 HIGH-DENSITY TIRE WITH ADJUSTED SHAPE
With puncture-proof tires that reduce friction and wear, the Prospector Pro 2.0 Tracks deliver trouble-free performance.
Confidently take on bumps and obstacles with 8" high-density tracks.

3 LIGHTWEIGHT POWDER COAT STEEL FRAME
Proven geometry to improve durability and deliver capability in all conditions throughout the life of the tracks.
A lighter frame provides more flotation to stay on top of the snow and allows the tracks to easily shed the elements they encounter.

4 TANDEM STABILIZER
The bolt-on, tandem mid-roller wheel provides a smoother ride by absorbing shocks.

5 BEARING HOUSING
Outer seals and stainless steel sleeves allow stronger bearing durability and greater reliability.

6 WHEEL CAP & SEAL
A fitted wheel cap with bladder effect eliminates water absorption due to temperature variation. Ride in snow or mud without worrying about track maintenance.

RZR TRAIL S

MAINTENANCE PARTS & FLUIDS



POLARIS ENGINEERED PARTS AND OIL have been validated and tested extensively, specifically for your vehicle. In order to maintain the peak performance of your Polaris vehicle only use official Polaris Engineered parts and oil.



We're taking the passion of our riders, workers, and outdoor enthusiasts to the next level with HD Parts. These Heavy Duty parts are engineered for riders who want greater durability and enhanced performance. HD Parts are designed and tested to handle greater wear and tear under all weather conditions.



A DRIVE BELT
 » 3211180
 TRAIL S 1000



B BRAKE PADS
 » FRONT • 2206025
 » REAR • 2203318



C OIL FILTER
 » 2540086
 » **HD** • 2522485



D BATTERY
 » 4015591



E AIR FILTER
 » 7082115



F SPARK PLUG
 » 3022662

LOOKING FOR MORE SERVICE PARTS?
 See P. 95 to learn how to find parts for your model.



MAINTENANCE SCHEDULE*

BREAK-IN MAINTENANCE	6 MONTHS	12 MONTHS	18 MONTHS
FIRST 25 HRS 250 MI / 400 KM	50 HRS 500 MI / 800 KM	100 HRS 1,000 MI / 1,600 KM	150 HRS 1,500 MI / 2,400 KM
ENGINE OIL & OIL FILTER CHANGE	BRAKE PAD INSPECT REPLACE AS NEEDED	ENGINE OIL & OIL FILTER CHANGE	BRAKE PAD INSPECT REPLACE AS NEEDED
BATTERY TEST & CLEAN REPLACE AS NEEDED	BRAKE FLUID INSPECT ADD AS NEEDED	BRAKE PAD INSPECT REPLACE AS NEEDED	BRAKE FLUID INSPECT ADD AS NEEDED
AIR FILTER INSPECT REPLACE AS NEEDED	BATTERY TEST & CLEAN REPLACE AS NEEDED	DRIVE BELT INSPECT REPLACE AS NEEDED	BATTERY TEST & CLEAN REPLACE AS NEEDED
FRONT GEARCASE INSPECT FLUID REPLACE AS NEEDED	AIR FILTER INSPECT REPLACE AS NEEDED	BATTERY TEST & CLEAN REPLACE AS NEEDED	AIR FILTER INSPECT REPLACE AS NEEDED
		AIR FILTER INSPECT REPLACE AS NEEDED	
		SPARK PLUGS INSPECT REPLACE AS NEEDED	
		FRONT GEARCASE CHANGE FLUID	
		TRANSMISSION CHANGE FLUID	



MAINTENANCE MADE EASY



OIL CHANGE KITS

3 L Engine Oil & 1 Oil Filter (2540086)
» PS-4 • 502543



ALL-SEASON GREASE TUBE

» 400 G • 502538



G

ENGINE OIL P. 84

- » PS-4 • 1 L • 502484
- » PS-4 • 4 L • 502485
- » PS-4 EXTREME • 1 L • 503220
- » PS-4 EXTREME • 4 L • 503221



H

DEMAND DRIVE FLUID

- For front gearcase.
- » 1 L • 502563
 - » 25 L • 502564
 - » 200 L • 502565



I

AGL

- For transmission
- » 1 L • 502505
 - » 25 L • 502507
 - » 200 L • 502508



J

DOT 4 BRAKE FLUID

- » 250 ML • 502526

Claims made based off testing and performance of Polaris HD Parts against standard OEM parts made by Polaris and competitor brands under normal use. For more information regarding Polaris HD parts including vehicle compatibility, installation and maintenance, please contact your authorized Polaris ORV dealer.

24 MONTHS **30 MONTHS** **36 MONTHS**

200 HRS | 2,000 MI / 3,200 KM

- ENGINE OIL & OIL FILTER**
CHANGE
- BRAKE FLUID**
CHANGE
- BRAKE PAD**
INSPECT
REPLACE AS NEEDED
- DRIVE BELT**
INSPECT
REPLACE AS NEEDED

- BATTERY**
TEST & CLEAN
REPLACE AS NEEDED
- AIR FILTER**
INSPECT
REPLACE AS NEEDED
- SPARK PLUGS**
INSPECT
REPLACE AS NEEDED
- FRONT GEARCASE**
CHANGE FLUID
- TRANSMISSION**
CHANGE FLUID

250 HRS | 2,500 MI / 4,000 KM

- BRAKE PAD**
INSPECT
REPLACE AS NEEDED
- BRAKE FLUID**
INSPECT
ADD AS NEEDED
- BATTERY**
TEST & CLEAN
REPLACE AS NEEDED
- AIR FILTER**
INSPECT
REPLACE AS NEEDED

300 HRS | 3,000 MI / 4,800 KM

- ENGINE OIL & OIL FILTER**
CHANGE
- BRAKE PAD**
INSPECT
REPLACE AS NEEDED
- DRIVE BELT**
INSPECT
REPLACE AS NEEDED
- BATTERY**
TEST & CLEAN
REPLACE AS NEEDED
- AIR FILTER**
INSPECT
REPLACE AS NEEDED

- SPARK PLUGS**
INSPECT
REPLACE AS NEEDED
- FRONT GEARCASE**
CHANGE FLUID
- TRANSMISSION**
CHANGE FLUID

FOR A COMPLETE MAINTENANCE SCHEDULE, CHECK YOUR OWNER'S MANUAL

*This is a sample maintenance schedule. Please reference and use your owners manual for full maintenance and vehicle care.



> YOUTH 200 EFI



LR
FULL WINDSHIELD

- Made of durable polycarbonate to protect the cab from dust, rain and wind
 - Lock & Ride offers easy, toolless installation
 - Integrates with the roof to prevent rain from entering the cab
- » 2884570
200 EFI '22-25



LR
HALF WINDSHIELD

- Made of durable polycarbonate to protect the cab from dust, rain and wind
 - Lock & Ride offers easy, toolless installation
 - Fully seals at the base for lower protection from the elements, while the open top-half enables airflow
- » 2884571
200 EFI '22-25

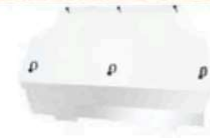

POLY REAR PANEL

- Made of durable .34 cm polycarbonate, which offers rider protection and visibility
 - Installs quickly and easily with P-clamps
 - Features scratch-resistant hard coating for enhanced durability
- » 2889777
200 EFI '22-25



BUMPERS

- Made of durable steel to provide great protection
 - Chassis integrated mounting
 - Front bumper offers integrated tow hook
- » FRONT • 2884577
200 EFI '22-25
» REAR • 2885144
200 EFI '22-25



ROCK SLIDERS

- Add durable protection from rocks or stumps
 - Chassis integrated mounting for easy install
 - Comes with two steel rock sliders
- » 2885146
200 EFI '22-25

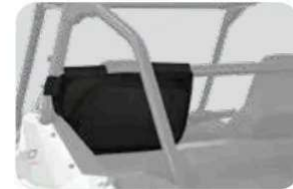

REAR STORAGE BAG

- 3 L storage capacity
 - Mounts to rear ROPS with a Velcro wrap
 - Made to withstand the elements and wear with durable ballistic nylon construction
- » 2885145
200 EFI '22-25



PRO ARMOR YOUTH SAND 8XT TIRE

- 8 paddles for optimized performance
 - Wider rear tires for better traction, grip and flotation on the sand
- » FRONT • 24" x 8" R12 • 5418458
» REAR • 24" x 10" R12 • 5418459
200 EFI '22-25



PRO ARMOR YOUTH CRAWLER TIRE

- 25" design provides additional ground clearance
 - Improved performance in all types of applications, from rock crawling to desert running
 - Double-belted sidewall for additional puncture-resistance
- » FRONT/REAR • 25" x 9.5" R12 • 5417953
200 EFI '22-25



PRO ARMOR WHEEL & TIRE SET: COMBAT & YOUTH SAND 8XT

- Not compatible with stock lug nuts; Requires metric lug nuts (2877384, 2877385), sold separately
- » FOUR WHEELS & TIRES • 2890260
200 EFI '22-25



POLY ROOF

- Durable HDPE material provides protection from the weather
- 4-bolt installation
- Integrates with full windshield to provide complete cab coverage

» 2889739
200 EFI '22-25



PRO ARMOR YOUTH COMBAT WHEEL

- Designed specifically for youth vehicles
- Increased strength and lightweight performance helps overcome obstacles on the trail
- Not compatible with stock lug nuts; Requires metric lug nuts (2877384, 2877385), sold separately

» FRONT • 12" x 7" • 1525222
200 EFI '22-25
» REAR • 12" x 7" • 1525421
200 EFI '22-25



PRO ARMOR WHEEL & TIRE SET: COMBAT & YOUTH CRAWLER

- Not compatible with stock lug nuts; Requires metric lug nuts (2877384, 2877385), sold separately

» FOUR WHEELS & TIRES • 2889869
200 EFI '22-25

MAINTENANCE PARTS & FLUIDS

POLARIS ENGINEERED PARTS AND OIL have been validated and tested extensively, specifically for your vehicle. In order to maintain the peak performance of your Polaris vehicle only use official Polaris Engineered parts and oil.



DRIVE BELT

» 3050270



BRAKE PADS

» FRONT • 2208176
» REAR • 2209841



OIL FILTER

» 3023344



BATTERY

» 4011434



AIR FILTER

» 7082249



SPARK PLUG

» 3050051

LOOKING FOR MORE SERVICE PARTS?

See P. 95 to learn how to find parts for your model.



ENGINE OIL

» SEE P. 84



AGL

» 1 L • 502505
» 25 L • 502507
» 200 L • 502508



DOT 4 BRAKE FLUID

» 250 ML • 502526



ALL-SEASON GREASE TUBE

» 400 G • 502538

MAINTENANCE SCHEDULE*

BREAK-IN MAINTENANCE	6 MONTHS	12 MONTHS
FIRST 12 HRS 100 MI / 160 KM	50 HRS 500 MI / 800 KM	100 HRS 1000 MI / 1600 KM
ENGINE OIL & OIL FILTER CHANGE	ENGINE OIL & OIL FILTER CHANGE	AIR FILTER REPLACE
BRAKE FLUID INSPECT ADD AS NEEDED	BATTERY CLEAN & TEST REPLACE AS NEEDED	BRAKE FLUID/ BRAKE PADS INSPECT ADD AS NEEDED / REPLACE AS NEEDED
BRAKE PADS INSPECT REPLACE AS NEEDED	GENERAL LUBRICATION ALL FITTINGS, PIVOTS, CABLES, ETC. REPEAT EVERY 6 MONTHS	DRIVE BELT / SPARK PLUGS INSPECT REPLACE AS NEEDED
		ENGINE OIL & OIL FILTER CHANGE
		TRANSMISSION CHANGE FLUID
		BATTERY CLEAN & TEST REPLACE AS NEEDED

FOR A COMPLETE MAINTENANCE SCHEDULE, CHECK YOUR OWNER'S MANUAL

*This is a sample maintenance schedule. Please reference and use your owners manual for full maintenance and vehicle care.



> WINCHES

DEPENDABLE. TOUGH. BUILT FOR THE OFF-ROAD.

A Polaris Engineered winch is designed to help you get the job done right, get you on your way faster and prepare you for the unexpected.

WHY POLARIS?

Polaris off road vehicles are engineered with designated mounting points and wiring for seamless install of Polaris Engineered winches.



TESTED 1,200+ PULLS AT MAX LOAD



BUILT TO WITHSTAND -29° C TEMPERATURES



OPERATES FULLY SUBMERGED



MILITARY TESTED & APPROVED

FEATURES & BENEFITS

ALL POLARIS ENGINEERED WINCHES COME WITH:

- ✓ INTEGRATED WIRING, MOUNT, PREASSEMBLED
- ✓ HOOK WITH STRAP
- ✓ CUT STEEL GEARS & SEALED DRIVETRAIN
- ✓ SEALED PERMANENT MAGNET MOTOR



Retrieve cable 5x as fast as standard mode on other Polaris winches. Get back to riding or complete your task quicker.

1. Set winch dial to N (Neutral) to manually pull the rope out and secure the hook to your anchor point
2. Set winch dial to L (Low) for maximum pulling power while winching your load
3. Set winch dial to H (High) for retrieving the rope 5x faster with Rapid Rope Recovery



Auto Stop technology protects and extends the life of your winch by automatically stopping the winch at the end of pull to prevent over-spooling. While plowing, it prevents the plow frame from bending by stopping the winch once the plow has been lifted.



With its lightweight, yet extremely strong, design and superior flexibility, this 15 m long synthetic rope is easy to handle and can stand up to any tough job.



This convenient remote operates your Polaris winch wirelessly from within 15 m of the vehicle. Operate your winch safely outside your vehicle while on the job site or trails.

UPGRADE YOUR CONTROLS

WIRED REMOTE CONTROL

» WIRED REMOTE CONTROL
2889562
Works with 2884835, 2884836

» REMOTE HANDLE
4013466
Works with 2882240
Socket required, sold separately

» SOCKET
4014228
Works with 2882240
Remote handle required, sold separately

REPLACEMENT PARTS

15 M STEEL CABLE
1,588 kg SERIES
» 2878890

15 M SYNTHETIC ROPE
1,588 kg SERIES 2,041 kg SERIES
» 2878888 » 2879187

MODEL

PRO R/4 '25
PRO S/4 '25
Includes dash switch and wireless remote

XP/4 '24-25
Includes wireless remote. Wired remote sold separately

TRAIL S '21-25
TRAIL '21-25

PRO XP/4 '25
Includes both wired and wireless remote



PRO HD SERIES | **HD SERIES**

✓ | ✓

✓ | NOT AVAILABLE

✓ | **ADD AUTO STOP UPGRADE**
2881693
Synthetic Rope required

✓ | **ADD SYNTHETIC ROPE**
2878888

✓ | **ADD WIRELESS REMOTE**
2879316

	2,721 kg	2,041 kg	2,041 kg	1,588 kg
	2890403	2890402		
		2884836	2884835	
		2885126 Requires Winch Cover Kit 2884118		2885127 Requires Winch Cover Kit 2884118
	2890399	2890398		

- COMMON
- WINCHES
- LIGHTING
- CONNECTED TECHNOLOGY
- COOLERS
- WHEELS & TIRES
- CLEANERS & TRAILERING



POLARIS ENGINEERED ADVANTAGES

MOUNTS PERFECTLY
Designed for your Polaris Engineered bumper, roof or other mounting point

ADVANCED TECH

RIGID lights are driven by Aluminum PCB Smart Boards, 6063-T5 aircraft aluminum extruded housings and Tiger Drylac UV protection polyester powder-coating.

EXCLUSIVE OPTICS

RIGID invests heavily in optical science and has patented multiple optics and optics systems, maximizing light output and efficiency.



LIGHT BAR TYPES



SR-SERIES PRO

Sleek, powerful, low-profile (under 5 cm tall). Lights extreme distances with low energy usage.
Available in 25.4 cm & 81.3 cm



D-SERIES PRO

Compact to fit almost anywhere with high output and low energy usage.
Available in Driving, Flood & Spot

OPTICS

DRIVING

FLOOD

SPOT

LIGHT BAR OPTIONS

1200 m
960 m
720 m
480 m
240 m

BRAND	RIGID	RIGID	RIGID	RIGID	RIGID	PRO ARMOR	PRO ARMOR
SIZE	POD	25.4 CM	POD	25.4 CM	POD	27.9 CM	27.9 CM
TYPE	D-SERIES	SR-SERIES	D-SERIES	SR-SERIES	D-SERIES	SINGLE-ROW	DUAL-ROW
RAW LUMENS	4,752	7,920	3,168	7,920	3,168	2,450	4,900
PN	2883128*	2883122*	2883126*	2883121*	2883127*	2889788 2889789	2889786 2889787
	<small>Comes in a pair</small>		<small>Comes in a pair</small>		<small>Comes in a pair</small>		



NEW PRO ARMOR ROCK LIGHTS

- Add style and nighttime functionality to your vehicle
- Universal mounting for wheel wells or other desired vehicle locations

- » WHITE • 2884645
- » RED • 2884683
- » BLUE • 2884684

MAX PERFORMANCE

Validated to work as hard as your machine does

DOESN'T OVERTAX

Trust it to work when you need it to

PRO ARMOR



RUGGED CONSTRUCTION

Pro Armor lights are designed to be big and beefy with an aggressive style all their own, and housed in IP67 marine-grade rated UV polyester powder-coating.

MASSIVELY BRIGHT

Pro Armor builds bright lights designed for any riding experience. All that power is directed through heat dissipating aluminum for streamlined heat management.



DUAL-ROW LED

The most spread and farthest illumination downrange. Easy to mount.

Available in 27.9 cm & 78.7 cm



SINGLE-ROW LED

Powerful, compact, low-profile light bars with a sleek look.

Available in 27.9 cm, 50.8 cm & 83.8 cm



CUBE LED

Small size allows mounting in strategic locations for added lighting.

Available in Spot

COMBO

OPTICS

1,200 m
960 m
720 m
480 m
240 m

PRO ARMOR CUBE

DUAL-ROW

1,500

2889794

2889795



RIGID 81.3 CM

SR-SERIES

20,064

2884648*



RIGID 25.4 CM

SR-SERIES

7,920

2883123*



PRO ARMOR 83.8 CM

SINGLE-ROW

7,500

2889791



PRO ARMOR 78.7 CM

DUAL-ROW

13,500

2889790



PRO ARMOR 50.8 CM

SINGLE-ROW

4,700

2889792

BRAND SIZE

TYPE

RAW LUMENS

PN

*Not available in Europe

ADD A HARNESS TO MOUNT YOUR LIGHTS

MODEL	LIGHT BAR SET-UPS	
	1 LIGHT in 1 LOCATION on 1 SWITCH	2 LIGHTS in 2 LOCATIONS on 1 SWITCH
TRAIL S '21-25 TRAIL '21-25	LIGHT BAR HARNESS 2884657	LIGHT BAR HARNESS 2884657 ADAPTER HARNESS 2412616 LED Y-HARNESS 2879860
PRO R/4 '22-25 PRO S/4 '25 PRO XP/4 '20-25 TURBO R/4 '22-24	LIGHT BAR HARNESS 2883949 ADAPTER HARNESS 2412616	LIGHT BAR HARNESS 2883949 ADAPTER HARNESS 2412616 LED Y-HARNESS 2879860
XP/4 '24-25	LIGHT BAR HARNESS 2889291	LIGHT BAR HARNESS 2889291 ADAPTER HARNESS 2412616 LED Y-HARNESS 2879860

LIGHT BAR MOUNT

- Optional cast mount for added style
 - Compatible with all Pro Armor light bars
- ➔ 2890053

ADDITIONAL LIGHT BAR OPTIONS

PRO R, PRO S & PRO XP | SEE P. 22

XP | SEE P. 42

All RIGID and Pro Armor lights are Polaris PULSE ready.

COMMON

WINCHES

LIGHTING

CONNECTED TECHNOLOGY

COOLERS

WHEELS & TIRES

CLEANERS & TRAILERING

> CONNECTED TECHNOLOGY

GO REMOTE.
STAY CONNECTED.



POLARIS RIDECOMMAND

PLAN YOUR RIDE

Plan an epic ride with stops along the way and ensure you're on a marked trail with Snap-to-Trail technology. Later, share your route with friends so you can hit the trails together.

DISCOVER NEW TRAILS

With over 1,000,000 miles of trails available offline, you'll have the confidence to explore further, whether you have cellular coverage or not.



- COMMON
- WINCHES
- LIGHTING
- CONNECTED TECHNOLOGY
- COOLERS
- WHEELS & TIRES
- CLEANERS & TRAILERING

7" DISPLAY POWERED BY RIDE COMMAND

Bright, glove-compatible touchscreen visible in all conditions.

GPS Navigation & Pre-Loaded Maps
Available offline on the in-dash display so you always know where you are.

Route Planning
Add points of interest and waypoints to make the most of your off-road adventure.

Camera Integration
Navigate with full view of your surroundings. Use the integrated rear

- » 2884072
PRO S/4 '25, PRO XP/4 '22-25, TRAIL S '22-25, TURBO/R 4 '22-24
- » 2890898
PRO R/4 '22-25, XP/4 '24-25
ON XP/4 '24 FOR OFF-ROAD USE ONLY ON TRACTOR AND ZUG VERSION

camera to see others behind you while riding.

Personalized Audio Experience
Seamlessly pair to your display via Bluetooth to wirelessly stream music and stay connected with call and text alerts.

Configurable Gauges
Customize your ride experience with elevation, travel direction, fuel level and more to create relevant screens for you.

FRONT CAMERA KIT

- TOPSELLER**
- Front camera upgrade for increased visibility and safety
 - Increases driver awareness of obstacles and terrain for enhanced riding
 - All wiring harnesses included on vehicle
 - » 2890416
PRO R/4 '22-25, PRO S/4 '25, PRO XP/4 '20-25, TURBO R/4 '22-24
 - » 2889169
XP/4 '24-25
 - » 2884432
TRAIL S '22-25

7" DISPLAY MOUNT KIT

- Replaces dash for seamless fit and finish
- Includes front and rear cameras with mounts
- Comes with wiring harnesses needed for RZR accessory components
- » 2890417*
PRO R/4 '25, PRO S/4 '25, PRO XP/4 '25
- » 2884584
PRO R/4 '22-24, TURBO R/4 '22-24, PRO XP/4 '20-24
- » 2889289
XP/4 '24-25
RIDE COMMAND Audio Adapter (2883232) required, sold separately
- » 2884731
TRAIL S '22-25

*Fall availability



> COOLERS

BUILT FOR THE
OFF-ROAD

28, 57 & 99
LITER FEATURES



ComfortCarry
Handles



TravellLock
System



EasyOut
Drain System



NoSlip
Rubber Feet



PolarWall
Insulation



IceLock
Seal



99 LITER

SAGEBRUSH GREEN • 2890707
GRAPHITE • 2883426

ACCESSORIES

WIRE BASKET • 2883648
DIVIDER (1) • 2883468
WHEELS • 2883967

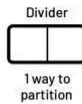

57 LITER

SAGEBRUSH GREEN • 2890706
GRAPHITE • 2883425

ACCESSORIES

WIRE BASKET • 2882185
DIVIDERS (2) • 2882184
SEAT CUSHION • 2882179
WHEELS • 2882180



28 LITER

SAGEBRUSH GREEN • 2890705
GRAPHITE • 2883424

ACCESSORIES

WIRE BASKET • 2882438
DIVIDER (1) • 2882186



ESSENTIAL ACCESSORIES SO YOUR COOLER WORKS AS HARD AS YOU DO





COMMON

WINCHES

LIGHTING

CONNECTED TECHNOLOGY

COOLERS

WHEELS & TIRES

CLEANERS & TRAILERING

POLARIS PERFORMANCE COOLERS CAN SURVIVE JUST ABOUT ANYTHING - FROM EXTREME HEAT TO A NASTY TUMBLE OFF A VEHICLE.



14 LITER
SAGEBRUSH GREEN • 2890704
GRAPHITE • 2883968



19 LITER SOFT-SIDED COOLER
GRAPHITE • 2889285



HOLDS ICE FOR AGES

BECAUSE JUST ANY COOLER WON'T CUT IT OUT THERE.

You need something rugged and reliable. A cooler purpose-built to handle the challenges of the off-road—while keeping your provisions on ice for days on end. Because out here, there are no ice machines, and you just left the last one in your dust. So, load it up. Lock it in. And know your NorthStar cooler is staying put—giving you a few extra days of ice time to enjoy the wild.



28 L COOLER BRACKET
2884070 PRO S/4 '25, PRO XP/4 '20-25, TURBO R/4 '22-24
2889200 PRO R/4 '22-25
2884526 XP/4 '24-25

> WHEELS & TIRES



PRO ARMOR

OFF-ROAD, IT'S ALL ABOUT FREEDOM & CREATING YOUR OWN PATH

As serious riders ourselves, we get it. And everything we design is to get (and keep) you going on the ride of a lifetime. We're for every style of rider looking to go beyond the expected with a ride that will make your story epic.





WHY CHOOSE PRO ARMOR?

SUPERIOR PERFORMANCE & DURABILITY

LIFELONG PERFORMANCE

- Every tire is designed and constructed with **longevity** in mind
- **3,000+ mile rated** (4,828 kilometers)

PREMIUM PROTECTION

- Pro Armor makes tires with **extra protection** exactly where it's needed most – the sidewall
- **Triple-belted sidewalls** keep your tires more resistant so you can keep going
Many competitors only use double-belted sidewalls

TOUGH TIRES

- Higher ply ratings mean added protection
- Pro Armor builds 8 or 10-ply rated tires for **higher puncture-resistance**

For off-road use only. Please check fitment with your dealer.

COMMON

WINCHES

LIGHTING

CONNECTED TECHNOLOGY

COOLERS

WHEELS & TIRES

CLEANERS & TRAILERING



> TIRES

Developed and tested with Polaris engineers, ensuring the perfect fit and optimal performance mile after mile.



15" WHEEL

DUAL-DUROMETER

PRO ARMOR ATTACK 2.0

All purpose tread pattern with a 10-ply radial construction provides excellent traction and increased durability.

Why Choose Attack 2.0?

Tighter lug spacing provides better traction in hard-pack & 10-ply construction provides long-lasting durability.



14" WHEEL

PRO ARMOR ATTACK

Aggressive tread design provides traction in any environment.

Why Choose Attack?

Great all-season tire with wider lug spacing for grip in softer terrain.



14" WHEEL
15" WHEEL

DUAL-DUROMETER

PRO ARMOR DUAL-THREAT

Dual compound technology for superior grip and traction.

Why Choose Dual-Threat?

Softer outer lugs for cornering grip and feel; harder inner lugs for longer tread life.



15" WHEEL

PRO ARMOR PRO RUNNER

Lightweight high-performance tire with aggressive lug design for incredible grip.

Why Choose Pro Runner?

Lightweight construction without sacrificing durability.



14" WHEEL
15" WHEEL

SINGLE-DUROMETER

PRO ARMOR CRAWLER XR

Premium grip for most terrains, from desert trails to the rocks.

Why Choose Crawler XR?

Tougher durometer allows for a shorter lug without sacrificing tread life and save weight. Excels in hard-pack, fast terrain.



15" WHEEL

DUAL-DUROMETER

PRO ARMOR CRAWLER AT

Handle anything the trail has to throw at you. In the sand or a rocky trail, these tires will stand up to almost anything.

Why Choose Crawler AT?

Directional lug pattern, more grip, better traction and wider lug spacing for excellent mud clean-out.



14" WHEEL
15" WHEEL
16" WHEEL

DUAL-DUROMETER

PRO ARMOR CRAWLER XG

Unmatched grip for rock crawling with a taller, softer lug.

Why Choose Crawler XG?

Perfect balance between high-speed performance, durability and flex for traction on slick rocks.



15" WHEEL

DUAL-DUROMETER

PRO ARMOR CRAWLER XP

The best in performance, durability, and reliability. Designed to tackle the toughest terrain in the most challenging conditions.

Why Choose Crawler XP?

Superior handling in soft dirt and clay. Extended side lugs for greater traction on rocks and sand.



12" WHEEL
14" WHEEL
15" WHEEL

PRO ARMOR TREKKER

The best balance of on-trail handling and low tire noise.

Why Choose Trekker?

Ultimate predictability with a quiet ride.



DUAL-COMPOUND

PRO ARMOR MUD XC

The best tread design that balances aggressive traction in the mud with a smoother ride on the trail.

Why Choose Mud XC?
Perfect mud-trail crossover.



PRO ARMOR HD-K

One of the strongest Pro Armor tires. Ride through corn stalks, thorns, jagged rocks or whatever else comes your way.

Why Choose HD-K?
Extremely strong tire for long life.



PRO ARMOR WHITEOUT

Engineered to charge through snow with unprecedented flotation and traction.

Why Choose Whiteout?
More surface area for better flotation on snow.



PRO ARMOR SAND 12XT

Precision engineered for hard turning bite and added flotation and stability.

Why Choose Sand 12XT?
Great for non-turbo RZR models that come stock with 29-30" tires.



PRO ARMOR SAND 16XT

Precision engineered for hard turning bite and added flotation and stability.

Why Choose Sand 16XT?
Best for high HP vehicles that require lots of traction in the sand.



KNOW YOUR TERRAIN



- Tread patterns optimized for extreme traction
- Ideal for both hard pack & loose trail



- Provides traction & durability
- Performs in hard sand, jagged rocks or any extreme terrain



- Flexible "grippy" tread
- Aggressive side bite



- Extra deep treads
- Self-cleaning lugs



- Paddles provide traction and durability in soft sand
- Built to float on top of sand



- Handles extreme cold
- Holds shape & provides traction



PRO ARMOR TIRES HAVE BEEN DEVELOPED AND TESTED to ensure the perfect fit, superior durability and optimal performance, mile-after-mile. No matter where you ride - mud, dirt, sand or snow - we've got you covered.

For off-road use only. Please check fitment with your dealer.

> WHEELS



16" 60-SERIES

15" 50-SERIES

A 6301 BEADLOCK

WEIGHT:	6.1 kg	LOAD RATING:	726 kg	OFFSET:	+38
ACCENT:	FRONT/REAR	16" x 7"	1523286		
MATTE BLACK:	FRONT/REAR	16" x 7"	1523285		

12mm x 1.5 SPLINED LUG NUTS

LUG NUTS REQUIRED

16 LUG NUTS WITH WRENCH • 2879332
 4 LUG NUTS WITHOUT WRENCH • 2879331
 SPLINED LUG WRENCH • 2204966
 PRO XP/4 '21-25, XP/4 '24-25, TRAIL/S '21-25, TURBO S '18-21,
 TURBO S 4 '20-21, XP TURBO/4 '18-21, XP 1000/4 '14-23,
 S 900 '15-20, S 4 1000 '18-20, S 1000 '16-20, 900 '14-20

BEADLOCK RINGS

BEADLOCK REQUIRED

- 15" 5203 BEADLOCK (Includes Bolts) MACHINED • 1522240-266
- 16" 5301 BEADLOCK REPLACEMENT MATTE BLACK • 1523147-458
- 14" 4203 BEADLOCK & HD DUAL BEADLOCK (Includes Bolts) MACHINED • 1522244-266
- 14" 4301 BEADLOCK REPLACEMENT & HD DUAL BEADLOCK MATTE BLACK • 1523146-458

KNOW YOUR WHEELS

STEP 1: SELECT SERIES

4 = 40-SERIES 5 = 50-SERIES 6 = 60-SERIES

STEP 2: CHOOSE LOAD RATING

1 = <362.9 kg 2 = 363 - 589.7 kg 3 = 590 - 726+ kg

STEP 3: PICK STYLE

OFFSET / BEADLOCK / COLOR

INCREASE OFFSET FROM STOCK = NARROWER STANCE
 DECREASE OFFSET FROM STOCK = WIDER STANCE

A 5101

WEIGHT:	6.6 kg	LOAD RATING:	363 kg	OFFSET:	-5
MATTE BLACK:	FRONT/REAR	15" x 10"	1523149-458		

B 5201

WEIGHT:	7.8 kg	LOAD RATING:	590 kg	OFFSET:	+4
MATTE BLACK:	FRONT/REAR	15" x 7"	1523184-458		

C 5202

WEIGHT:	8.1 kg	LOAD RATING:	590 kg	OFFSET:	+4
ACCENT:	FRONT/REAR	15" x 7"	1523102-266		
MATTE BLACK:	FRONT/REAR	15" x 7"	1523102-458		

D 5203 BEADLOCK

WEIGHT:	7.3 kg	LOAD RATING:	590 kg	OFFSET:	+38
MATTE BLACK:	FRONT/REAR	15" x 7"	1522435-458		

E 5204

WEIGHT:	6.1 kg	LOAD RATING:	590 kg	OFFSET:	+55
MATTE BLACK:	FRONT/REAR	15" x 7"	1522550-458		

F 5205

FRONT WEIGHT:	6.8 kg	LOAD RATING:	408.2 kg	OFFSET:	-4
REAR WEIGHT:	9.1 kg	LOAD RATING:	408.2 kg	OFFSET:	-38
MATTE BLACK:	FRONT	15" x 8"	1523727-458		
	REAR	15" x 10"	1523728-458		

G 5207/5303

FRONT WEIGHT:	6.1 kg	LOAD RATING:	590 kg	OFFSET:	-4
REAR WEIGHT:	6.1 kg	LOAD RATING:	590 kg	OFFSET:	-38
MATTE BLACK:	FRONT	15" x 10"	1524043		
	REAR	15" x 8"	1524042		

ONLY COMPATIBLE WITH PRO R/4, PRO S/4 & TURBO R/4

H 5208

WEIGHT:	5.8 kg	LOAD RATING:	544 kg	OFFSET:	+55
MATTE BLACK:	FRONT/REAR	15" x 7"	1525454		

I 5301 BEADLOCK

WEIGHT:	7.7 kg	LOAD RATING:	726 kg	OFFSET:	+38
ACCENT:	FRONT/REAR	15" x 7"	1523282		
MATTE BLACK:	FRONT/REAR	15" x 7"	1523266		

J 5302 BEADLOCK

WEIGHT:	6.1 kg	LOAD RATING:	590 kg	OFFSET:	+55
MATTE BLACK:	FRONT/REAR	15" x 7"	1524038		

ONLY COMPATIBLE WITH PRO R/4, PRO S/4 & TURBO R/4

K 5304 BEADLOCK

WEIGHT:	7.3 kg	LOAD RATING:	726 kg	OFFSET:	+62
MATTE BLACK:	FRONT/REAR	15" x 7"	1525420		

ONLY COMPATIBLE WITH PRO R/4, PRO S/4 & TURBO R/4

L 5305 BEADLOCK

WEIGHT:	8.4 kg	LOAD RATING:	748 kg	OFFSET:	+38
MATTE BLACK:	FRONT/REAR	15" x 7"	1525455		

M 5306

WEIGHT:	6.8 kg	LOAD RATING:	789 kg	OFFSET:	+62
MATTE BLACK:	FRONT/REAR	15" x 7"	1525684		

ONLY COMPATIBLE WITH PRO R/4, PRO S/4 & TURBO R/4

N 5307

WEIGHT:	7.3 kg	LOAD RATING:	789 kg	OFFSET:	+62
MATTE BLACK:	FRONT/REAR	15" x 7"	1525686		

ONLY COMPATIBLE WITH PRO R/4, PRO S/4 & TURBO R/4

O 5307 BEADLOCK

WEIGHT:	8.2 kg	LOAD RATING:	789 kg	OFFSET:	+62
MATTE BLACK:	FRONT/REAR	15" x 7"	1525688		

ONLY COMPATIBLE WITH PRO R/4, PRO S/4 & TURBO R/4

5 Wheels with 5 Lug Nuts. Only compatible with Pro R/4, Pro S/4 & Turbo R/4.

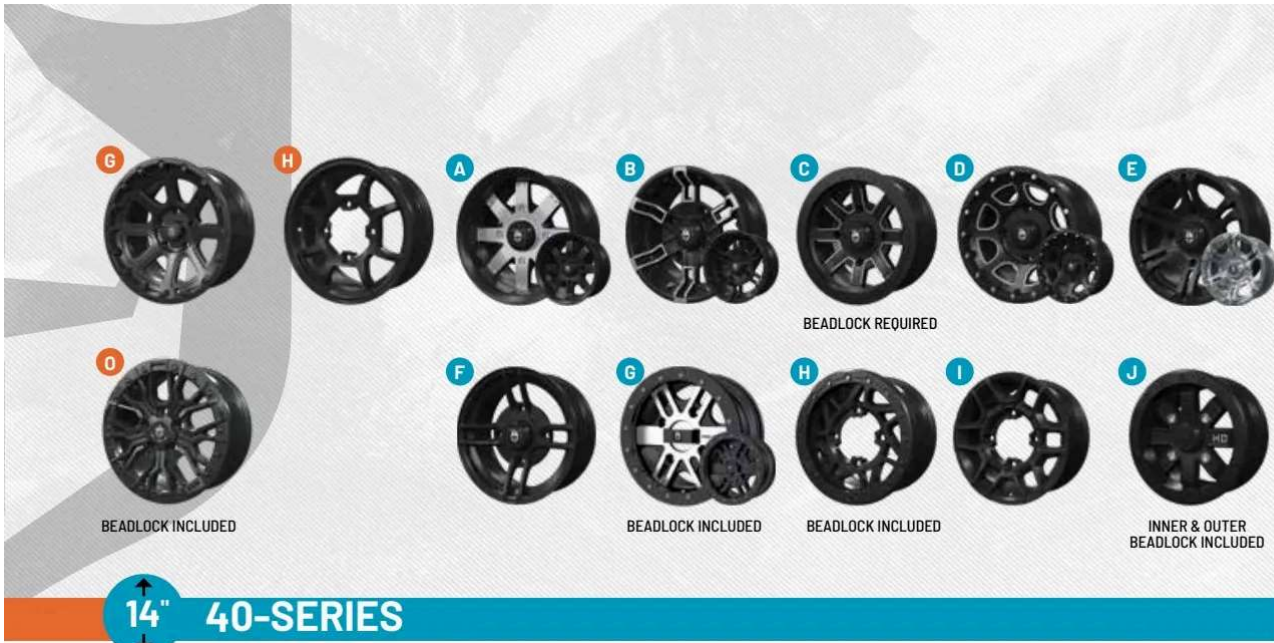

COMMON
WINCHES
LIGHTING
CONNECTED TECHNOLOGY
COOLERS
WHEELS & TIRES
CLEANERS & TRAILERING

A 4201

FRONT WEIGHT:	5.9 kg	LOAD RATING:	408.2 kg	OFFSET:	+9
REAR WEIGHT:	6.4 kg	LOAD RATING:	590 kg	OFFSET:	+9
ACCENT:	FRONT	14" x 7"	1522956-266		
	REAR	14" x 8"	1522957-266		
MATTE BLACK:	FRONT	14" x 7"	1522956-458		
	REAR	14" x 8"	1522957-458		

B 4202

FRONT WEIGHT:	5.8 kg	LOAD RATING:	408.2 kg	OFFSET:	+4
REAR WEIGHT:	6.1 kg	LOAD RATING:	590 kg	OFFSET:	-9
ACCENT:	FRONT	14" x 7"	1522544-266		
	REAR	14" x 8"	1522545-266		
MATTE BLACK:	FRONT	14" x 7"	1522544-458		
	REAR	14" x 8"	1522545-458		

C 4203 BEADLOCK

FRONT WEIGHT:	5.9 kg	LOAD RATING:	408.2 kg	OFFSET:	+4
REAR WEIGHT:	6.6 kg	LOAD RATING:	590 kg	OFFSET:	-9
MATTE BLACK:	FRONT	14" x 7"	1522238-458		
	REAR	14" x 8"	1522239-458		

D 4204

FRONT WEIGHT:	5.9 kg	LOAD RATING:	408.2 kg	OFFSET:	+4
REAR WEIGHT:	6.4 kg	LOAD RATING:	590 kg	OFFSET:	-9
ACCENT:	FRONT	14" x 7"	1522546-266		
	REAR	14" x 8"	1522547-266		
MATTE BLACK:	FRONT	14" x 7"	1522546-458		
	REAR	14" x 8"	1522547-458		

E 4205

FRONT WEIGHT:	4.8 kg	LOAD RATING:	408.3 kg	OFFSET:	+4
REAR WEIGHT:	5.7 kg	LOAD RATING:	590 kg	OFFSET:	-9
MATTE BLACK:	FRONT	14" x 7"	1521507-521		
	REAR	14" x 8"	1521508-521		
LUSTER:	FRONT	14" x 7"	1521507-410		
	REAR	14" x 8"	1521508-410		

F 4206

FRONT WEIGHT:	4.3 kg	LOAD RATING:	408.2 kg	OFFSET:	+4
REAR WEIGHT:	4.9 kg	LOAD RATING:	590 kg	OFFSET:	-9
MATTE BLACK:	FRONT	14" x 6"	1522542-458		
	REAR	14" x 8"	1522543-458		

G 4301 BEADLOCK

WEIGHT:	7.3 kg	LOAD RATING:	726 kg	OFFSET:	+38
ACCENT:	FRONT/REAR	14" x 7"	1523284		
MATTE BLACK:	FRONT/REAR	14" x 7"	1523283		

H 4302 BEADLOCK

WEIGHT:	18.1 kg	LOAD RATING:	725.7 kg	OFFSET:	+58
MATTE BLACK:	FRONT/REAR	14" x 7"	5418036		

I 4303

WEIGHT:	18.1 kg	LOAD RATING:	725.7 kg	OFFSET:	+58
MATTE BLACK:	FRONT/REAR	14" x 7"	5418037		

J HD DUAL BEADLOCK

WEIGHT:	18.1 kg	LOAD RATING:	725.7 kg	OFFSET:	+28
MATTE BLACK:	FRONT/REAR	14" x 7"	1524022-458		

For off-road use only. Please check fitment with your dealer.



KNOW YOUR TERRAIN



- Tread patterns optimized for extreme traction
- Ideal for both hard-pack and loose trail



- Flexible "grippy" tread
- Aggressive side bite



- Provides traction and durability
- Built to perform in hard sand, jagged rocks or any other extreme terrain

> WHEEL & TIRE SETS

2 WAYS TO PURCHASE

INDIVIDUAL WHEELS & TIRES
- OR -
COMPLETE SETS AS LISTED

Exclusively at Polaris Authorized Dealers



40-SERIES

BACKCOUNTRY/TRAIL

	ATTACK 26"	DUAL-THREAT 26"	29"	TREKKER 27"	29"
4201 Accent	2882390	2883138	2883146		
4201 Matte Black	2882391	2883139	2883147		
4202 Accent	2881335	2883140	2883148	2890907	2890906
4202 Matte Black	2881336	2883141	2883149	2890905	2890904
4203 BEADLOCK Matte Black BEADLOCKS SOLD SEPARATELY	2881381				
4204 Accent	2881347	2883142	2883150		
4204 Matte Black	2881348	2883143	2883151		
4205 Luster	2881359				
4205 Matte Black	2881360	2883144	2883152		
4206 Matte Black	2881404	2883145	2883153		
4301 BEADLOCK Accent BEADLOCKS PRE-MOUNTED		2883217	2883219		
4301 BEADLOCK Matte Black BEADLOCKS PRE-MOUNTED		2883216	2883218		
4302 BEADLOCK Matte Black BEADLOCKS PRE-MOUNTED	2889549	2889550	2889551	2890909	2890908
4303 Matte Black	2889541	2889542	2889543	2890911	2890910



50-SERIES

BACKCOUNTRY/TRAIL

MUD

DESERT/ROCK

	28"	ATTACK 2.0 30"	32"	DUAL-THREAT 32"	30"	TREKKER 32"	33"	MUD XC 30"	CRAWLER AT 30"	32"
5201 Accent	2883160	2883169	2890201	2883694				2890209	2889510	2889518
5201 Matte Black	2883159	2883168	2890202	2883693				2890210	2889511	2889519
5202 Accent	2883158	2883167	2890203	2883696				2890211	2889512	2889520
5202 Matte Black	2883157	2883166	2890204	2883695	2890916			2890212	2889513	2889521
5203 BEADLOCK Matte Black BEADLOCKS SOLD SEPARATELY	2883154	2883163	2890205	2883699				2890213	2889516	2889524
5204 Matte Black	2883155	2883164	2890206	2883700				2890214	2889517	2889525
5208 Matte Black		2890179	2890180	2890181	2890915			2890182	2890174	2890175
5301 BEADLOCK Accent BEADLOCKS PRE-MOUNTED	2883162	2883171	2890207	2883698	2890914			2890215	2889514	2889522
5301 BEADLOCK Matte Black BEADLOCKS PRE-MOUNTED	2883161	2883170	2890208	2883697	2890913			2890216	2889515	2889523
5302 BEADLOCK Matte Black				2885009		2890926	2890931			
5304 BEADLOCK Matte Black BEADLOCKS PRE-MOUNTED			2890675							2890000
5305 BEADLOCK Matte Black					2890912			2890165		
5306 Matte Black			2890933	2890934		2890922	2890927			2890942
5307 Matte Black			2890952	2890953		2890923	2890928			2890961
5307 BEADLOCK Matte Black			2890971	2890972		2890924	2890929			2890980



60-SERIES

ROCK/RACE

CRAWLER XG 32"

6301 BEADLOCK Accent BEADLOCKS PRE-MOUNTED	2883703
6301 BEADLOCK Matte Black BEADLOCKS PRE-MOUNTED	2883702

⊖ Lug Nuts required. See previous page for Caps, Beadlock Rings and Lug Nuts.

Ⓜ Wheels with 5 Lug Nuts. Only compatible with Pro R/4, Pro S/4 & Turbo R/4.



- Extra deep treads
- Self-cleaning lugs



- Paddles provide traction and durability in soft sand
- Built to float on top of sand



- Triple-belted sidewalls to resist puncture
- Purpose-built, long lasting tread patterns



- Handles extreme cold
- Holds shape and provides traction

COMMON

WINCHES

LIGHTING

CONNECTED TECHNOLOGY

COOLERS

WHEELS & TIRES

CLEANERS & TRAILERING

	MUD		DESERT/ROCK			SAND
	27"	MUD XC 29"	30"	CRAWLER XG 32"	CRAWLER XR 28"	SAND 12XT 30"
	2884272	2884265	2882396	2882452	2882394	
	2884273	2884266	2882397	2882451	2882395	
	2884267	2884260	2881560	2882448	2881343	
	2884268	2884261	2881561	2882447	2881344	
				2881382	2881386	
	2884270	2884263	2881558	2882450	2881355	
	2884271	2884264	2881559	2882449	2881356	2884034
			2881564		2881371	
	2884269	2884262	2881563	2882453	2881372	
			2883211	2883215	2883213	
			2883210	2883214	2883212	
	2889552	2889553	2889555	2889556	2889554	
	2889544	2889545	2889547	2889548	2889546	

	CRAWLER XG			33"	CRAWLER XP		CRAWLER XR			PRO RUNNER		15" SAND 16XT		
	28"	30"	32"		30"	32"	30"	32"	33"	30"	32"		30"	32"
	2883188	2883179	2889986	2890191	2889950	2889958	2890183	2883194	2884744			5205 Matte Black	2884035	2884036
	2883187	2883178	2889987	2890192	2889951	2889959	2890184	2883193	2884736			5207/5303 Matte Black		2885020
	2883186	2883177	2889988	2890193	2889952	2889960	2890185	2883192	2884737	2885024	2885031	2885038		
	2883185	2883176	2889989	2890194	2889953	2889961	2890186	2883191	2884738	2885025	2885032	2885039		
	2883182	2883173	2889992	2890195	2889956	2889964	2890187	2882444	2884741	2885028	2885035	2885042		
	2883183	2883174	2889993	2890196	2889957	2889965	2890188	2882445	2884743	2885030	2885037	2885044		
		2890166	2890167	2890168	2890169	2890170	2890171	2890172	2890173	2890176	2890177	2890178		
	2883190	2883181	2889991	2890197	2889954	2889962	2890189	2883196	2884739	2885026	2885033	2885040		
	2883189	2883180	2889990	2890198	2889955	2889963	2890190	2883195	2884740	2885027	2885034	2885041		
			2890025	2890200		2889948		2885010	2885008		2885011	2885012		
			2890027			2889997		2889998						
					2890152	2890153								
			2890939	2890940		2890947		2890944	2890945		2890936	2890937		
			2890958	2890959		2890966		2890963	2890964		2890955	2890956		
			2890977	2890978		2890985		2890982	2890983		2890974	2890975		



SAND

5205 Matte Black

5207/5303 Matte Black



SNOW

5101 Matte Black

WHITEOUT 30"

2883172

For off-road use only. Please check fitment with your dealer.

VALVES



COLBY SHORT ULTIMATE VALVE (2 PACK)
» 2883292



COLBY EMERGENCY VALVE (2 PACK)
» 2883293



ORDERABLE THROUGH LOCAL DEALER ONLY

COLBY COMBO VALVE KIT (16 PACK)

- Includes 8 ultimate and 8 emergency valves
- » 2883294

CLEANERS

CLEAN

ALL-PURPOSE CLEANER

- Professional cleaner, which is formulated with a low pH-value. The product spreads well on surfaces and adheres on them for effective cleaning action. Perfectly compatible with rubber, plastic and painted surfaces. The formulation is biodegradable.

» 500 mL • 502309

SHINE

INSTANT SHINE & DETAILER

- The INSTANT SHINE AND DETAILER is developed for cleaning action without water. Removes insects, dust and dirt with almost no effort. Applicable for plastics, visors, windscreens, paint and metal. The wipe and shine formulation makes surfaces shine, works water repellent and also has an antistatic effect. Perfect for customers living in urban areas with no access to water, for bike trips or showroom bikes.

» 500 mL • 502546



TRAILERING

RAMPS



CALIBER RAMP PRO

- Designed for ATVs and UTVs up to 127 cm wide
- Integrated grip glides for ultimate traction
- Folding sides for easy transportation and storing

» 132 cm x 229 cm • 2884576



ALUMINUM ARCHED LOADING RAMPS

- Capacity for up to 1,361 kg
- » 193 cm x 30.5 cm • 907 kg • 2875384
- » 224 cm x 30.5 cm • 1,361 kg • 2875386



LIGHTWEIGHT TRI-FOLD RAMPS

- Ramp folds up for transport
- Capacity for up to 681 kg
- Safety straps included
- » 183 cm x 130 cm • 2875385
- » 208 cm x 130 cm • 2875860



FOLDING ALUMINUM ARCHED RAMPS

- Ramp folds up for transport
- Up to 680 kg total capacity, 340 kg per individual ramp
- Safety straps included
- » 224 cm x 30.5 cm • 2875387

COVERS

TRAILERABLE COVER BY POLARIS

PRO XP

» 4-SEAT • 2883989
PRO XP 4 '20-25

» 2-SEAT • 2883764
PRO XP '20-25

XP

» 4-SEAT • 2884522
XP 4 '24-25

» 2-SEAT • 2884521
XP '24-25



TRAIL S / TRAIL

» 2-SEAT • 2885092
TRAIL S '21-25, TRAIL '21-25

MISC



OFF-ROAD TOOL KIT BY CRUZTOOLS®

» 2890429
ALL MODELS



RZR WHIP FLAG & POLE

» 2881468
ALL MODELS

CV BOOT REPAIR KIT*

FIX ON THE GO | TEMPORARY COVERAGE

- A quick trail-side fix to increase trail time
- The flexible and durable boot material expands over a cone tool for CV boot repairs, without disassembling CV axles
- Universal fit - works as a temporary fix for most powersports axles
- All components fit inside the cone, and a cover is provided for compact durable storage
- Easily fits in a cargo box, attached to the roll cage, in the glovebox or many other storage locations



Items shown are contained inside cone

UTV CV BOOT REPAIR KIT

Kit includes the following items:

- (1) Expandable XL CV Boot
 - (1) Reusable Cone Tool
 - (2) CV Boot Clamps
 - (1) Tube of Silicone Lube
 - (1) Grease Packet
 - (1) Cone Cover
- » 2830526

UTV TRAIL BOOT ONLY

» 2830527

ATV

» CV REPAIR KIT 2830528

» TRAIL BOOT ONLY 2830529

HOW TO INSTALL

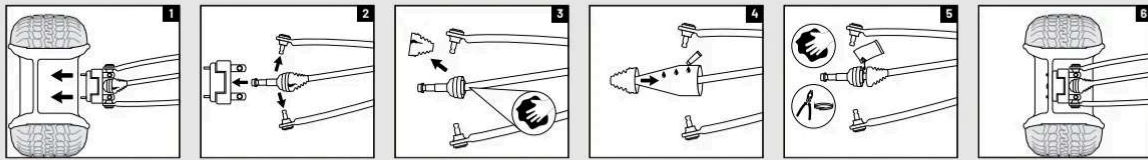

1 Remove wheel and axle nut.

2 Remove brake caliper, hub, tie rod and upper and lower ball joints.

3 Remove old boot and clean joint.

4 Spread silicone lube on entire cone tool. Slide boot over cone tool, large end first. See package for outer boot instructions.

5 Empty the bag of grease into the CV joint/boot, clean sealing points and install clamps.

6 Reassemble tie rod, ball joints, brake caliper, axle nut, tire and wheel.

Refer to your service manual for further instructions and torque specifications.
*Designed for temporary CV boot repair. Purchase the OEM CV Boot for a permanent repair.

HITCHES



HITCH WITH 5 CM BALL

- 3:1 Hitch: ball, hook and pin design
 - Rust resistant steel with powdercoat finish
 - Removable ball, HD 1.6 cm pin and clip
- » 5 cm x 5 cm RECEIVER • 2830522
» 3 cm x 3 cm RECEIVER • 2830523



4.8 CM BALL

- 4.8 cm replacement ball for hitch
 - Designed to work with 3:1 Hitch
- » 2830524



RECEIVER HITCH

» 5 cm RECEIVER TONGUE • 2875320



TRAILER BALL 1.9 CM SHANK

» 4.8 cm BALL • 2877602
» 5 cm BALL • 2877603

STRAPS & ROPES



RECOVERY STRAP

- 5 cm x 9 m
 - 8,165 kg maximum load, 4,082 kg maximum vehicle weight
 - Comes with carry bag
- » 2884033



RATCHET STRAP

- 3.8 cm x 4.6 m straps, 2-pack
 - Heavy duty webbing
 - 2,495 kg maximum load, working load
- » 2884031



RATCHET STRAP

- 5 cm x 6.1 m
 - Heavy duty webbing, floating D-rings, double J-hooks
 - 4,536 kg maximum load, 1,497 kg working load
- » 2884032



SHOCK STRAPS

- 3.8 cm 1,361 kg breaking strength
 - Keeps tension on tie-down straps to secure load
 - 2-Pack
- » 3.8 cm x 4.6 m • 2883296
» 3.8 cm x 2.1 m • 2883295



SPARE TIRE RATCHETING Y-STRAP

» 2689506

COMMON

WINCHES

LIGHTING

CONNECTED TECHNOLOGY

COOLERS

WHEELS & TIRES

CLEANERS & TRAILERING

OIL & LUBRICANTS

Our PS-4 engine oils provide ultimate performance and protection, they're formulated with exclusive additives to keep engines clean from deposit buildup. These powersports-grade full synthetic oils helps maximize power and protect your engine for the long term.

**PS-4 FORMULATIONS
BEST PROTECTION,
BEST PERFORMANCE**

PS-4 5W-50 FULL-SYNTHETIC OIL

Optimal for ambient operating temperatures of -40° C to 38° C.

1L 502484 4L 502485 25L 502486 60L 502487 200L 502488

PS-4 0W-50 EXTREME FULL-SYNTHETIC OIL

Optimal for ambient operating temperatures of -43° C to 54° C.

1L 503220 4L 503221 25L 503233 » 60L 503236 » 200L 503235

PS-4
5W-50

OIL CHANGE KITS

These convenient kits include everything needed including filter and oil volume per vehicle

PART NUMBER	VEHICLE FITMENT
502541	SINGLE 570, TWIN 600, TWIN 700, TWIN 800
502543	RANGER/RZR/GENERAL 900/1000
502542	SPORTSMAN 570/1000

POLARIS INVESTS IN EACH OIL AT & ABOVE THESE LEVELS

**12+ DEDICATED
TEAM MEMBERS**

FOCUSED ON POLARIS OIL

**18+
MONTHS**

DEVELOPMENT & TESTING

**76,000+
HOURS**

DYNO TESTING

**3.5 MILLION+
KILOMETERS**

FIELD TESTING



**DOT 4
BRAKE FLUID**

A high-quality brake fluid designed for use in Polaris hydraulic brakes.
» 250 ML • 502526



**ALL-SEASON
GREASE TUBE**

Specialized water-resistant lubricant
» 400 G • 502538



**PREMIUM GAS
SHOCK OIL**

» 1 L • 502518



AGL

Protects transmission components against wear, corrosion, oxidation and foam in transmissions.

» 1 L • 502505
» 25 L • 502507
» 200 L • 502508



MAINTENANCE & GARAGE
 OIL & LUBRICANTS
 JUMP STARTERS & SERVICE PARTS

POLARIS
EXTREME
 SYNTHETICS

PS-4 EXTREME SYNTHETIC 0W-50

- Our best extreme high and low temp formula, excellent for high temperatures and racing, even at temps of 54°C, plus easier cold starting even below -42°C
- Expect the best in wear protection thanks to premium PAO and ester base stocks combined with a balance of moly and ZDDP additives
- Polaris exclusive clean engine additive system reduces deposits and carbon build-up for peak performance and power

THE BEST PROTECTION, MAXIMUM PERFORMANCE

- Powersports grade full synthetics provide long lasting engine protection
- At least 40% improved wear protection compared to all aftermarket oils tested (see engine wear test chart)
- Polaris exclusive clean additive system
- At least 50% less deposits than all aftermarket oils tested (see deposit test chart)
- Cleaner engine with less deposits means consistent maximum power and performance

WIDEST VISCOSITY FOR ULTIMATE PROTECTION



ENGINE WEAR TEST

LOWER NUMBER = LESS ENGINE COMPONENT WEAR
 LESS WEAR ON PARTS MEANS LONGER ENGINE LIFE

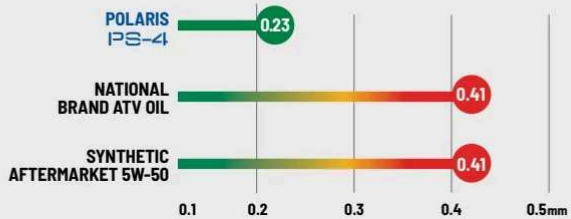

ASTM D4172. In 3rd party testing against 9 competitive products Polaris had 40% or better wear protection compared to all of the tested products. Numbers represent mm of wear scarring measured. Test measures wear at contact points, wear scar is measured for its length and width (in units of mm). Lower wear numbers mean better wear protection and friction reduction.

DEPOSIT TEST

LOWER DEPOSITS = MAXIMUM POWER

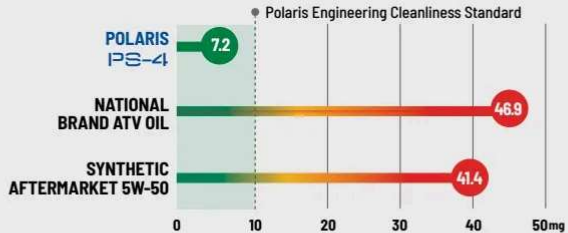

ASTM D6335. In 3rd party testing against 9 competitive products Polaris PS-4 had less than half the deposits compared to the next closest product. No other tested products met Polaris Engineering standards for deposit cleanliness. Test measures mass of deposits in mg in high temp, high stress test cycles. Higher deposits will impact engine power and performance.



DEMAND DRIVE FLUID

Proprietary formulation prevents clutch slippage and chatter and reduces component wear and corrosion.

- » 1L • 502563
- » 25 L • 502564
- » 200 L • 502565

PRO R / 4 REQUIRES ANGLE DRIVE FLUID (503320)



ANTI-FREEZE

Prevent corrosion on metal components, eliminate scaling and maximize cooling system performance.

- » 1 L • 502566
- » 25 L • 502567
- » 206 L • 502568



CARBON CLEAN

Ultimate fuel and injection system cleaner.

- » 125 ML • 502528



FUEL STABILIZER

Fuel Stabilizer prevents ethanol corrosion and stabilizes fuel for up to 2 years. Dual-antioxidant formula protects against gum and varnish for easy starting.

- » 125 ML • 502519
- » 355 ML • 2882519

JUMP STARTERS

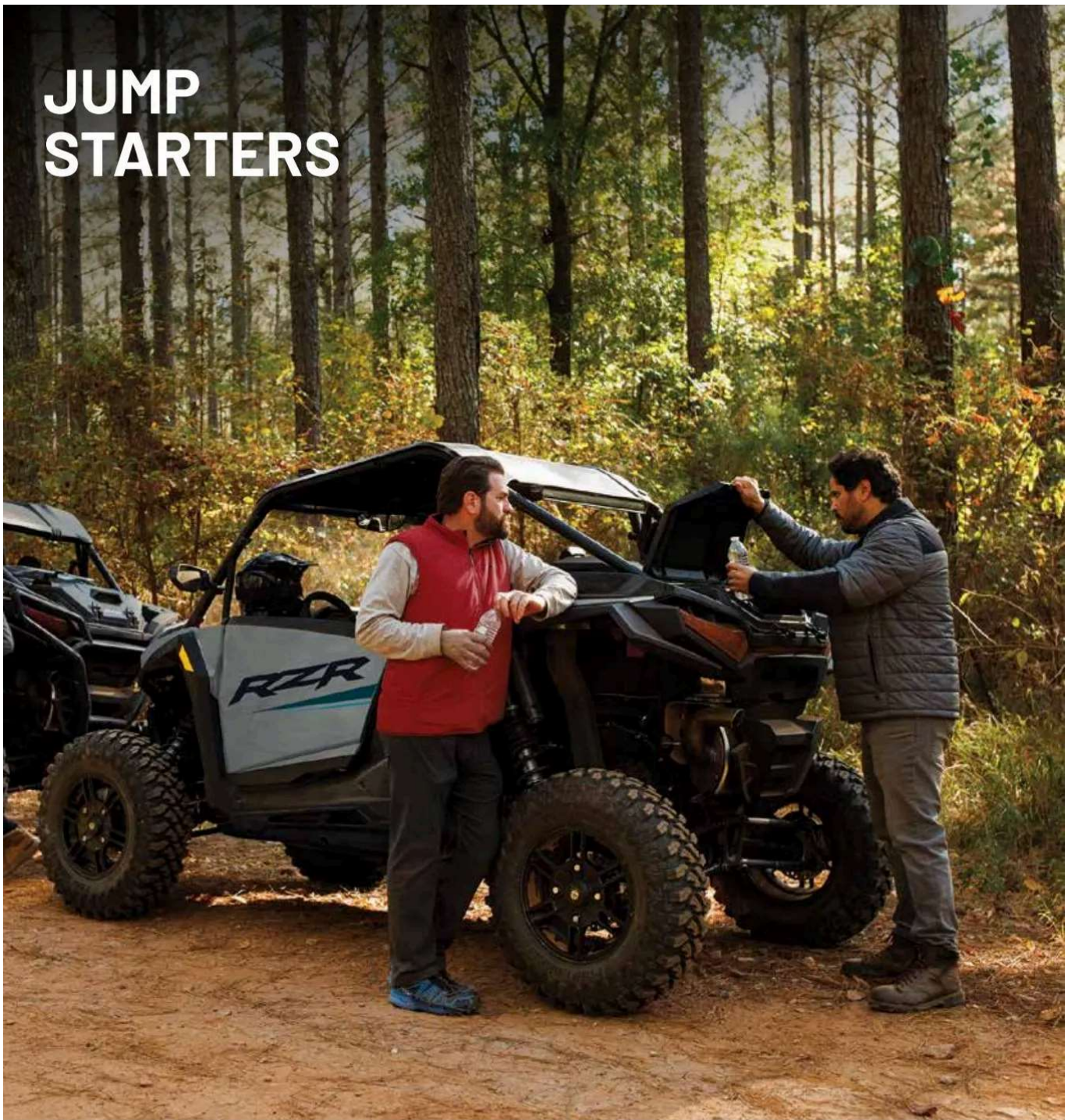

**NOCO BOOST® GB40 12V
1000A JUMP STARTER**

- Delivers 1,000 amps for jump starting a dead battery in seconds
- » 2830547



**NOCO BOOST® GB70 12V
2000A JUMP STARTER**

- Delivers 2,000 amps for jump starting a dead battery in seconds
- » 2830597



**NOCO BOOST® JUMP PACK
PROTECTION CASES**

- Lightweight, durable and rugged custom exterior
- » GB40 • 2830548
- » GB70 • 2830598

YOUR BATTERY
IS READY
WHEN YOU ARE

SERVICE PARTS



POLARIS ENGINEERED SERVICE PARTS DELIVER UNMATCHED PERFORMANCE AND FIT FOR YOUR OFF-ROAD VEHICLE.

All service parts are engineered specifically for your machine. Which means everything is designed, tested and perfected to maximize the life of your ride. Getting Polaris Engineered parts is a decision that pays off in the long run, because there is a long run.

VISIT YOUR POLARIS DEALER TO SHOP FOR SERVICE PARTS.



FOR THE LIFE OF YOUR RIDE

Maintenance is the key to keeping your Polaris off-road vehicle performing at its peak. Items like belts, lubricants, and batteries represent only a few of these critical items engineered specifically by Polaris.



TESTED, PERFECTED

We test each belt on the intended vehicle - we don't just try to make an existing belt "just work".

- Amery Kuhl,
Polaris CVT System Engineer

POLARIS ENGINEERED DRIVE BELTS

OUR INVESTMENT

- 32,187 km of field testing
- Thousands of dyno hours
- 18+ months of development (3,000+ design hours) per belt
- 1,200+ vehicle validation hours
- Collaboration with powertrain & clutch engineers

YOUR ADVANTAGE

- No clutch recalibration
- Less wear & tear due to heat
- Ensure maximum performance of your vehicle
- More time out riding, less time wrenching

OUR INVESTMENTS ENSURE POLARIS BELTS OUTPERFORM YOUR EXPECTATIONS.



APPAREL

FIT FOR ANY ADVENTURE. For outdoor enthusiasts looking for gear that's purposefully built to stand up to the fun and challenging experiences Polaris vehicles enable. Each piece of apparel and equipment bearing the name Polaris is crafted by outdoor enthusiasts, for outdoor enthusiasts. They are a badge of honor – representing what the Polaris brand stands for – a passion to simply be outside doing what you love.

> RZR APPAREL & MERCH

APPAREL
RZR APPAREL & MERCH
JERSEYS, SLOUVES & GAITERS
HOME & COLLECTIBLES
RACING COLLECTION
HELMETS & GOGGLES



RZR LOGO POCKET TEE

MEN'S | S-3XL
Black | 2865584
Sand | 2865585



RZR DESERT DUSK TEE

MEN'S | S-3XL
Black | 2865586
Gray | 2865587
YOUTH | S-XL | Black | 2865596



RZR V-NECK TEE

WOMEN'S | S-3XL
Black | 2865593
Fuchsia Heather | 2865594



RZR LIFE TEE

MEN'S | S-3XL
Navy | 2864727
Red | 2864728



RZR GEAR UP TEE

WOMEN'S | S-3XL
Purple Frost | 2864734
Heather Gray | 2864735



ROCK IT TEE

MEN'S | S-3XL
Navy | 2864732
Red | 2864733
YOUTH | S-XL | Navy | 2864731



RZR TEE

MEN'S | S-3XL
Olive | 2864744
Red | 2864745
Black/Red | 2861936



RZR PERFORMANCE LONG SLEEVE

MEN'S | S-3XL
Black/Gray | 2864729
Blue/Gray | 2864730



RZR DUNES LONG SLEEVE TEE

WOMEN'S | S-3XL
Blue | 2865592
Black | 2864736
Heather Gray | 2864737



RZR 3D LOGO HOODIE

MEN'S | S-3XL
Charcoal | 2865590
Sand | 2865591



RZR UPF HOODIE TEE

MEN'S | S-3XL
Lime | 2865493
Dark Gray | 2833074
Orange | 2833075



RZR FULL ZIP LOGO HOODIE

MEN'S | S-3XL
Red | 2865588
Cypress/Orange | 2864725
Black/Lime | 2864724



RZR FULL ZIP TECH HOODIE

MEN'S | S-3XL
Black | 2864738
Blue | 2864739
Orange | 2864740



RZR LIGHTWEIGHT HOODIE

WOMEN'S | S-3XL
Dark Gray | 2864726
Dusty Rose | 2862571
Sage | 2862731



RZR VAPOR HOODIE

MEN'S | S-3XL
Orange | 2864741
Black | 2862495
Gray | 2869593



RZR VAPOR HOODIE

WOMEN'S | S-3XL
Teal | 2865595
Gray | 2864742
Olive | 2864743



RZR 3D LOGO TRUCKER CAP

Light Gray | 2865582
Blue | 2865583



RZR PATCH CAP

Cypress | S/M: 2864747 | L/XL: 2864748
Gray/Blue | S/M: 2833514 | L/XL: 2833515
Black/Red | S/M: 2860607 | L/XL: 2860608



RZR FLAT BILL

Red | 2864746
Black | 2862596
Navy | 2861546



RZR PRO CAP

Black | 2833135
Gray | 2862546



RZR PARKING SIGN
2869932



RZR FLAG
152 cm x 91.4 cm | 2862684



RZR STICKER 6"
15.24 cm x 4.45 cm | 2861865

> JERSEYS, GLOVES & GAITERS



RZR THROTTLE JERSEYS

ADULT: S-3XL | YOUTH: S-XL

- Mesh ventilated panels for maximum airflow
- Elastic sleeves with non-restrictive cuffs

WHITE/BLUE Adult 2865376	TAN/ORANGE Adult 2865377 Youth 2865382	FUCHSIA/GRAY Adult 2865379 Youth 2865381	TEAL/LIME Adult 2865378	BLACK Adult 2865374	BLUE Adult 2865375 Youth 2865380
--------------------------------------	---	---	-------------------------------------	---------------------------------	---



RZR THROTTLE GLOVES

ADULT: S-3XL | YOUTH: S-XL

- Adjustable wrist closure for a custom fit
- Silicon finger grips and neoprene knuckle protection
- Gloves are not CE-certified

WHITE/BLUE Adult 2865385	TAN/ORANGE Adult 2865386 Youth 2865391	FUCHSIA/GRAY Adult 2865388 Youth 2865390	TEAL/LIME Adult 2865387	BLACK Adult 2865383	BLUE Adult 2865384 Youth 2865389
--------------------------------------	---	---	-------------------------------------	---------------------------------	---



RZR NECK GAITERS

- Keep the sun off your neck and the dust off your face
- Stretchy and seamless material
- UPF 15-18 for sun protection and moisture-wicking

BLUE 2833138	LIME 2861952	CAMO 2861948	RZR SCENIC 2861949	BLACK 2861953	RZR BLACK 2861951	RED RETRO 2861950	RZR RED 2833139
------------------------	------------------------	------------------------	------------------------------	-------------------------	-----------------------------	-----------------------------	---------------------------

>HOME & COLLECTIBLES



POLARIS KEY RACK
30.5 cm x 20 cm | 2864718



POLARIS LED SIGN
61 cm x 26.7 cm | 2862736



POLARIS RACING LED SIGN
61 cm x 22.9 cm | 2862737



ALUMINUM SIGN
55.9 cm | 2860867



WOOD SIGN
61 cm x 26.7 cm | 2860866



POLARIS STEEL SIGN
91.4 cm x 35.6 cm | 2860868



POLARIS PARKING SIGN
2869934



POLARIS FLAG
152 cm x 91.4 cm | 2869928



DECK OF CARDS
2860816



POLARIS PVC COASTERS
2864715



POLARIS NOTEBOOK
2860831



LEATHER KEY CHAINS
Leather Loop | 2861615
Black Leather | 2861616



PADDOCK UMBRELLA
2800625



HITCH COVER
2861623



LICENSE PLATE HOLDER
2862687



RZR PARKING SIGN
2869932

APPAREL

RZR APPAREL & MERCH

JERSEYS, GLOVES & GAITERS

HOME & COLLECTIBLES

RACING COLLECTION

HELMETS & GOGGLES

>RACING COLLECTION



HELMET

- Polycarbonate shell
- Removable & washable lining
- Double lens system with integrated sun visor
- Quick release micrometric adjustment system
- Weight: 1450 g (+/-50 g)

Black Matte | XS-2XL | 2802408
 White Gloss | XS-2XL | 2802311
 Dark Gray Matte | XS-2XL | 2802312

ECE 22.06

- 1 shell and 2 EPS: XS-M, L-XXL
- ECE 22-06 approved



BOOTS

- Waterproof and breathable lining
- Full-grain oil treated leather upper
- Specific ATV double density compound rubber sole
- Adjustable Velcro® closure
- Replaceable/adjustable plastic buckles
- Anti-bacterial replaceable footbed
- CE-approved motorcycle boots EN 13634:2017

Black | EU39 - 47 | 2802313
 Brown | EU39 - 47 | 2802314



SPORT JACKET

- Light and water repellent jacket
- Ideal for ATV and SxS ride in wet weather
- 2 zipped pockets on the outside and 2 inside pockets
- Laser cut under the arms for better ventilation

Black | XS-4XL | 2802409



SPORT PANTS

- Light and water repellent pant
- Ideal for ATV and SxS in wet weather
- Ergonomic cut and stretch to gain comfort
- 1 zipped pocket
- Belt adjustment with micrometric buckle

Black | XS-4XL | 2802410



TECHNICAL SHIRT

- 100% polyester
- Indelible sublimated graphics
- Hemmed edging
- Lycra cuffs and collar

Men's | Black | S-3XL | 2802404
 Women's | White | S-2XL | 2802405



SAFETY GLOVES TOUCH



- CE-approved motorcycle glove EN 13594:2015
- Touch screen compatible
- Silicon print on fingers to improve grip
- Neoprene cuff with Velcro® tightening
- Reinforcements patches for safety and comfort

Khaki | S-3XL | 2802309
 Black | XS-7, 3XL-13 | 2802103



NEO GLOVES



- CE-approved motorcycle glove EN 13594:2015
- 100% synthetic neoprene glove
- Touch screen compatible
- Knuckle protected
- Reinforcements patches for safety and comfort

Black | XS-7, 3XL-13 | 2802310



SF TECH GLOVES TOUCH



- CE-approved motorcycle glove EN 13594:2015
- Touch screen compatible
- Knuckle-protected
- Silicon print on fingers to improve grip
- Neoprene cuff with Velcro® tightening
- Reinforcements patches for safety and comfort

Khaki | S-3XL | 2802308
 Black | XS-7, 3XL-13 | 2802102



NEW
HYBRID HOODIE

- Sporty sweatshirt with padded front
- 80g quilted front
- Hood and sleeves in interlock knit

Black | S-3XL | 2800325



NEW
PACKABLE PUFFER JACKET

- Lightweight packable padded down jacket
- Suitable for mid-season or as a mid-layer
- Packable in a practical pouch provided
- Can be easily stored in your vehicle
- Main material 100% polyamide
- Insulation 100% polyester

Dark Blue | S-3XL | 2800125



WATERPROOF JACKET

- 100% polyester 2.5 Layer stretch fabrics
- PU membrane waterproof and breathable 3000 mm / 3000 gr
- All seams taped and WR main zipper
- Adjustable hood
- Ventilation system on back to improve ventilation

Black | S-3XL | 2802403



NEW
PUFFY JACKET 2.0

- Top body and shoulder polyester woven 3000 mm/3000 gr + welded quilting
- Lower body nylon 380T downproof
- 80gr padding
- Inner elastic bottom tightening
- Two external pockets with easy-grab puller

Black | S-3XL | 2800725



PADDED JACKET

- Shoulder and hood softshell waterproof and breathable 3000 mm/3000 gr
- Lower body and sleeve, polyester woven waterproof and breathable 3000 mm/3000 gr
- Quilted lining with 80 gr padding
- Elasticized lower body tightening
- Two external pockets with easy-grab puller

Black | S-3XL | 2802306



NEW
PADDOCK RAINCOAT

- Waterproof rain coat made of polyester fabrics with PVC coating on outside
- All seam are high frequency welded
- Raglan sleeve shape
- Two front patch pocket with flaps
- Front opening with snaps

Black | M/L, XL/XXL | 2800425



BODYWARMER

- Upper body and side panels in softshell waterproof and breathable 3000 mm/3000 g
- Lower body nylon downproof
- Padding 80 g
- Two external pockets with easy-grab puller

Khaki | S-3XL | 2802304
Black | S-3XL | 2802101



RACING SOFTSHELL

- Softshell waterproof and breathable 3000 mm/3000 g
- Removable hood
- Four external pockets with easy-grab puller

Women's | Black | S-XL | 2802402
Men's | Khaki | S-3XL | 2802305
Men's | Black | S-3XL | 2802003



HYBRID JACKET

- Sleeves in softshell waterproof and breathable 3000 mm/3000 g
- Body nylon downproof
- Padding 80 g
- Three external pockets with easy-grab puller

Khaki | S-3XL | 2802401
Black | S-3XL | 2802004

>HELMETS



CARBON FIBER BLACK
S-2XL | 2833158



DELTA V COMMANDER

NO LONGER A HELMET, IT'S A COCKPIT

S-2XL

SHELL

- Carbon fiber
- Lightweight polycarbonate

WEIGHT

- Up to 1,832 g

FEATURES

- The Delta V Commander features an integrated communication system, infinity style sealed IGNITE heated shield, and ergonomic design
- Features in-helmet JBL® speakers for audio and an integrated microphone to connect up to 14 users in a group with the best sound and noise cancellation for all your rides
- Venturi Vent Ducting, an integrated spoiler, and low-profile antennae keeps this helmet sleek, quiet, and fog-free all day on the trails
- 12-volt power input on left side powers shield, comms, and chase light with controls for bright, normal, and off positions
- Battery power for up to 10 hours of riding
- Connect via Bluetooth™ to your music, phone, maps, and sled
- DOT/ECE 22.06 dual certified helmet shell and luxurious liner
- Fidlock® chinstrap for easy on and off



BLACK
2833151



WHITE
2833150



TEAL/LIME
2865411



NEW

TACTICAL 3.0 MTN

EXPERIENCE TOP-TIER PROTECTION, COMFORT, AND CONNECTIVITY IN THE MOUNTAINS

XS-4XL

SHELL

- Poly and ABS Polymer Construction - ensures both strength and a lightweight feel for maximum protection

WEIGHT

- Starting at 1,300g

FEATURES

- Venturi Vent system generates negative pressure at velocity and pulls moist air from the breath box
- Cardo® UCS Compatibility - integration and easy assembly of Cardo® UCS modules (sold separately)
- Magnetic Fidlock® chin-strap technology
- Plush liner design
- Compatible with VEES Protection System (sold separately) for cold days
- DOT-and ECE 22.06-approved



BLUE
2865412



RETRO
2865409



BLACK
2865408



V.E.E.S. LINER
2865412

GOGGLES



NEW
FUCHSIA/GRAY
2865427

509 KINGPIN



FEATURES

- Built for off-road, the oversized spherical lens delivers optimal peripheral vision
- Metal tear-off posts provide strength and durability
- Quick-change technology allows you to run the best lens tint for conditions



OLIVE/LIME
2864546

STEALTH
2862560

NEW
BLUE/WHITE
2865428



NEW
MAROON/FUCHSIA
2865435

TENACITY 4.0

COMBINATION OF MODERN STYLE & PREMIUM PROTECTION WITH INCREDIBLE VALUE

XS-2XL

SHELL

- Shock-resistant, injection-molded thermoplastic

WEIGHT

- 1,500g

FEATURES

- Through-flow, full-helmet ventilation
- ProClip quick release chin strap allows you to fasten the chin strap in seconds
- Removable breath box and removable, washable liner
- Tool-less adjustable roost shield
- DOT/ECE 22.06 dual certified helmet shell



BLACK
2865418

FOR POLARIS FIDLOCK.

NEW

YOUTH TACTICAL 3.0

EMPOWER THE NEXT GENERATION OF RIDERS WITH CUTTING EDGE TECH

S-L

SHELL

- Poly and ABS Polymer construction ensures both strength and a lightweight feel for maximum protection

FEATURES

- Venturi Vent system generates negative pressure at velocity and pulls moist air from the breath box
- Cardo UCS Compatibility - integration and easy assembly of Cardo UCS modules (sold separately)
- Plush liner design
- Magnetic Fidlock chin-strap technology to enable faster securing and removing of the helmet
- DOT-and ECE 22.06-approved



NEW
GRAY/BLUE
2865434



BLACK/LIME
2864560



BLACK
2864859



TEAL/LIME
2865420



NEW
TEAL/LIME
2865430

509 MX6



FEATURES

- PC outer lens with anti-scratch coating, and internal anti-fog coating
- Outriggers with latch system for quick lens change
- 45mm strap with silicone to hold strap in place



NEW
TEAL/LIME
2865429

YOUTH RIPPER



FEATURES

- Excellent visibility
- Anti-fog performance
- Scratch resistant durability



ORANGE
2864545

BLACK
2862557

NEW
BLUE
2865431



CRUISER BLACK
2864549

RIDE OF YOUR LIFE



POLARIS
Think Outside

Warning: Polaris off road vehicles can be hazardous to operate and are not designed for on-road use. Driver must be at least 16 years old with a valid driver's license to operate. All riders should always wear helmets, eye protection and footwear. Read, understand and follow your owner's manual. Ride within the limits of your own abilities and never engage in stunt or exhibition driving. Never ride under the influence of drugs or alcohol. All riders should take a safety training course.

Unless noted, trademarks are the property of Polaris Industries Inc. 509® is a registered trademark of Teton Outfitters, LLC. App Store® is a registered trademark of Apple Inc. Bluetooth® is a registered trademark of Bluetooth Sig, Inc. Caliber® is a registered trademark of Caliber Products Inc. Cardo® is a registered trademark of Cardo Systems, Inc. CruzTOOLS® is a registered trademark of Cycoactive, Inc. Facebook™ is a service trademark of Facebook, Inc. FOX® is a registered trademark of Fox Factory Inc. Fidlock® is a registered trademark of Fidlock GmbH. GatorStep® is a registered trademark of GatorStep LLC. Google Play™ is a service trademark of Google LLC. YouTube® is a registered trademark of Google LLC. Instagram™ is a service trademark of Instagram, LLC. MORFLEX® is a registered trademark of FNA Group, LLC. NOCO Boost® and NOCO Genius® are registered trademarks of The Noco Company. Pandora® is a registered trademark of Pandora Media, LLC. RIGID® is a trademark of JST Performance, LLC d/b/a Rigid Industries LLC. Rockford Fosgate® is a registered trademark of Rockford Corporation. S&B® is a registered trademark of S&B Filters, Inc. SMART BOARD® is a registered trademark of Smart Technologies ULC Unlimited Liability Corporation Canada. Tiger Drylac® is a registered trademark of Tiger Coatings GMBH & CO. Twitter™ is a service trademark of X CORP. Velcro® is a registered trademark of Velcro IP Holdings LLC. YKK® is a registered trademark of YKK Corporation. Fitment and availability are subject to change. Copyright © 2024 Polaris Industries Inc. All rights reserved.

Availability varies by market, check your local dealer for availability. Images taken on private land. The use of vehicles in similar environments in your jurisdiction may be prohibited per locally applicable laws and regulations. Campfires in similar environments in your jurisdiction may be prohibited per locally applicable laws and regulations. Keep your campfire safe, and make sure you can control it at all times. Know your locally applicable laws and regulations. Crossing water in similar environments may be prohibited in your jurisdiction.

MY25 RZR APP ACC EMEA