

POLARIS SPORTSMAN



2025

**ACCESSORIES,
MAINTENANCE & APPAREL**

EMEA VERSION

FORGE YOUR OWN PATH

The ATV that defined the industry, Sportsman combines legendary smoothness, unstoppable versatility and an ease of use that the competition continues to chase, which is why Sportsman is chosen by more ATV owners. Whether you're tearing up the trails, working out in the fields, or navigating the wilderness for the perfect hunt, there is a Sportsman story to be told.

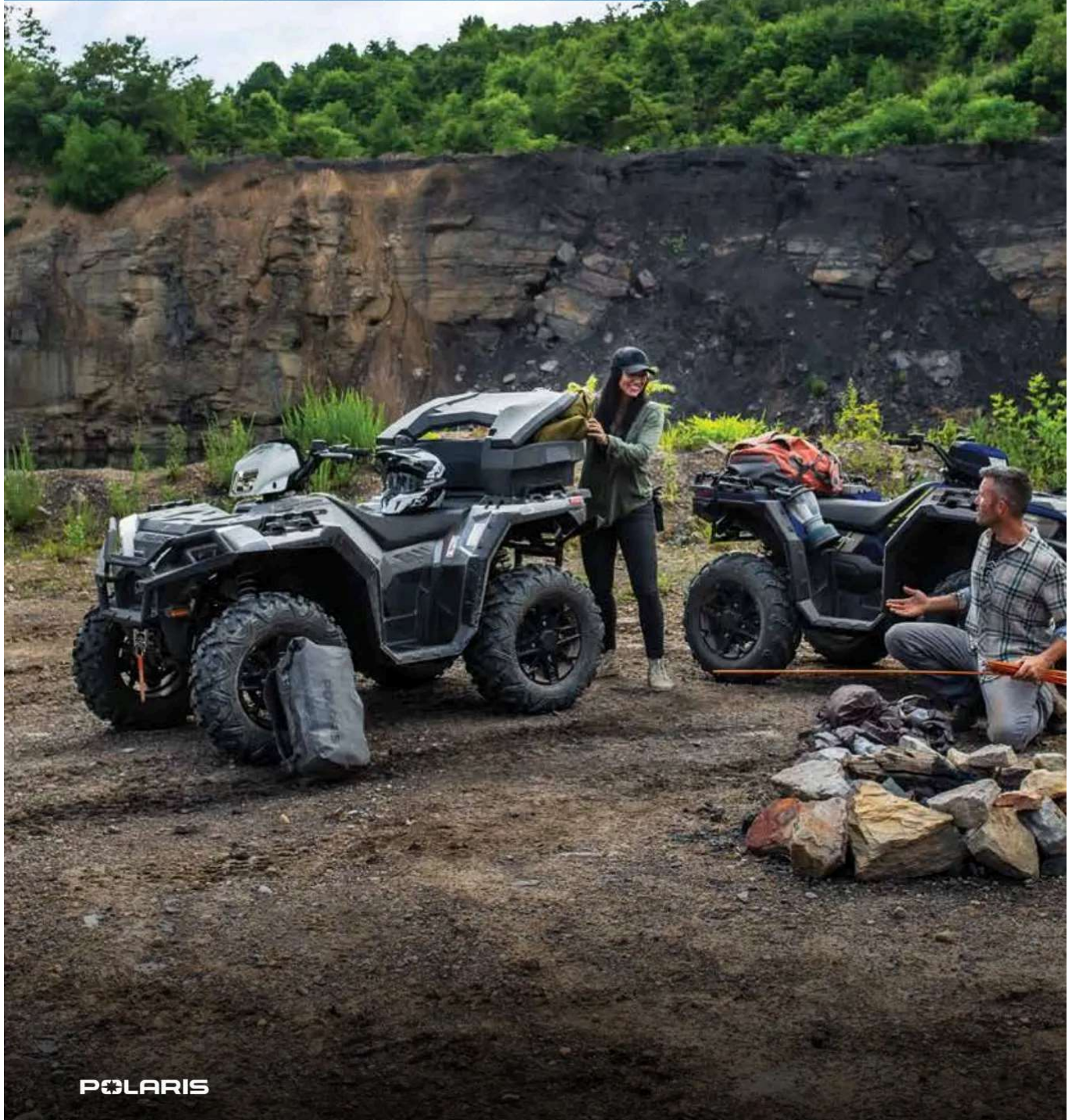

POLARIS



POLARIS SPORTSMAN

10 570

- 12 WINCHES, RACKS & PROTECTION
- 14 COMFORT, AUDIO & STORAGE
- 16 WINDSHIELDS
- 18 570 X2, 570 6x6 & TOURING 570
- 24 MAINTENANCE PARTS & FLUIDS

26 XP 1000 / XP 1000 S

- 28 WINCHES & WINDSHIELDS
- 29 RACKS & PROTECTION
- 30 STORAGE, AUDIO & COMFORT
- 32 MAINTENANCE PARTS & FLUIDS

34 SCRAMBLER XP 1000 S

38 MISCELLANEOUS & YOUTH

40 COMMON ACCESSORIES

- 40 WINCHES
- 42 PLOWS
- 44 TRACKS
- 46 LIGHTING
- 48 CONNECTED TECHNOLOGY
- 50 HUNT
- 52 COOLERS
- 54 WHEELS & TIRES
- 60 CLEANERS & TRAILERING

62 MAINTENANCE & GARAGE

- 64 OIL & LUBRICANTS
- 66 JUMP STARTERS & SERVICE PARTS

68 APPAREL

- 69 JERSEYS, GLOVES & GAITERS
- 71 RACING COLLECTION
- 72 CASUALWEAR & HATS
- 73 HOME & COLLECTIBLES
- 74 HELMETS & GOGGLES

IMPORTANT: Adding accessories may impact the vehicle's conformity to its homologation or type approval. Polaris recommends consulting with local authorities and/or your local dealer to understand the requirements and restrictions related to the installation of accessories on your vehicle.

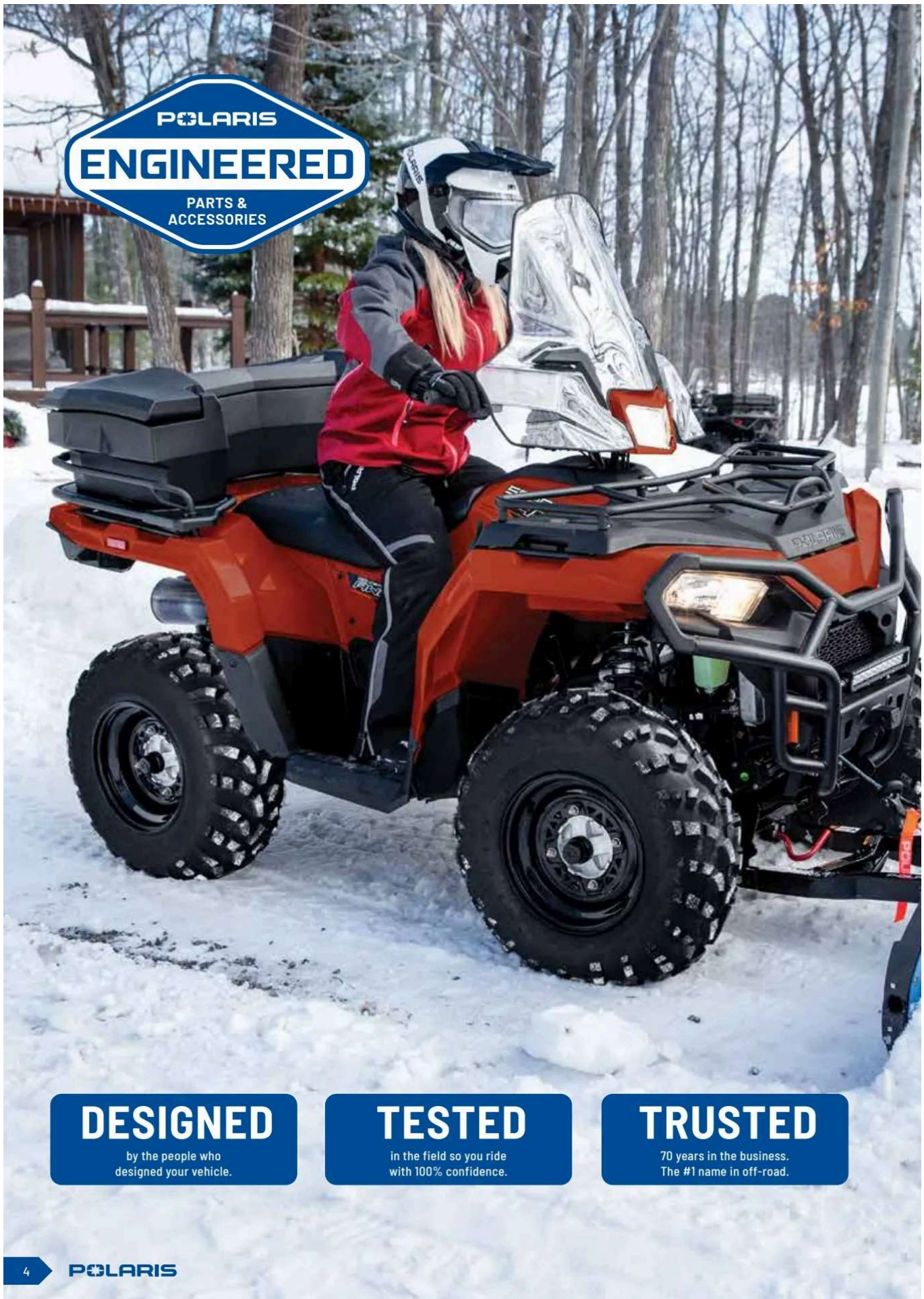

POLARIS
ENGINEERED
PARTS &
ACCESSORIES

DESIGNED
by the people who
designed your vehicle.

TESTED
in the field so you ride
with 100% confidence.

TRUSTED
70 years in the business.
The #1 name in off-road.

KEEP YOUR
STANDARDS HIGH.
 WE DO.



**WE HOLD OUR PARTNERS
 TO THE SAME STANDARDS**

Sharing an outdoor adventure with a companion or two gives your experience its very own energy. When we meet another brand that builds and tests their products with the same rigor as we do, a kinship forms. So we give them an exclusive partner badge and invite them along for the ride. It's another way we bring you the best options for customizing your Polaris vehicle without compromise. How better to send you and your crew out into the world?



ENGINEERED FOR MORE

Ensuring Polaris Engineered Accessories fit and work in sync with your machine is the most critical phase of testing and validation. With seamless integration, you can trust that any Polaris accessory you install will enhance your experience beyond your expectations.



CARGO VERSATILITY

Lock & Ride mounting locations allow for limitless customization to let you work the way you want.

P. 15, 20, 30



ENHANCE YOUR RIDE

Ride in confidence with industry-leading technology showing you the way.

P. 48





PRO HD SERIES HEAVY DUTY WINCHES

INTEGRATED WINCH MOUNT & PRE-WIRED

Designated mounting points and pre-wired connectors for a perfect fit and the strongest place to attach a Polaris Engineered winch - the most dependable winch for your Sportsman. With wiring built right into the vehicle, we made this the easiest winch to install on a Sportsman.

P. 40



GLACIER PLOW SYSTEMS

INTEGRATED PLOW MOUNT

The attachment points for the Glacier Plow System are integrated right at the factory and feature an innovative drive-up and go installation process.

P. 42



SUPERIOR INTEGRATION

PRO HD SERIES HEAVY DUTY WINCHES



✓ Pre-wired chassis & no need to cut panels

Factory-installed wiring makes the controls simple to install. Mount the winch, connect the wires and trust that everything is routed safely, securely, and properly.

- ✓ Tested 1,200+ pulls at max load**
- ✓ Built to withstand -29° C temperatures**
- ✓ Operates fully submerged underwater**
- ✓ Military tested and approved**



- 1 Sealed permanent magnet motor**
- 2 Cut steel gears and sealed drivetrain**

3 PREMIUM SYNTHETIC ROPE

With its lightweight, yet extremely strong, design and superior flexibility, this 15.2 m long synthetic rope is easy to handle and can stand up to any tough job.

4 RAPID ROPE RECOVERY 5x FASTER

Retrieve cable 5x faster than standard mode on other Polaris winches. Get back to riding or complete your task quicker.

5 AUTO STOP TECHNOLOGY

Auto Stop technology protects and extends the life of your winch by automatically stopping the winch at the end of pull to prevent over-spooling. While plowing, it prevents the plow frame from bending by stopping the winch once the plow has been lifted.

✓ WIRELESS REMOTE

This convenient remote operates your Polaris winch wirelessly from within 15.2 m of the vehicle. Operate your winch safely outside your vehicle while on the job site or trails.

LEARN MORE ABOUT POLARIS ENGINEERED WINCHES

P. 40

Right from the factory, your vehicle is built to make essential accessories like winches and plows easy to use day-in and day-out. Mounting brackets are designed into the oversized factory bumper and wiring is routed securely and properly. When it comes to Sportsman, Polaris Engineered Accessories make work easier so you can get more done.



GLACIER PLOW SYSTEMS



- ✓ Easily install and remove the plow system from your Sportsman
- ✓ No loss of factory ground clearance when not plowing
- ✓ Don't have to crawl under the machine to release the plow blade from the vehicle
- ✓ No trimming of vehicle plastic required to mount plow or winch
- ✓ Angle your blade right from your seat with the Glacier Pro Plow Hydraulic Angle System
- ✓ 30 seconds: Drive up, hook on, lock down, and go

LEARN MORE ABOUT
THE GLACIER PLOW SYSTEM
P. 42



DRIVE UP



HOOK ON



LOCK DOWN

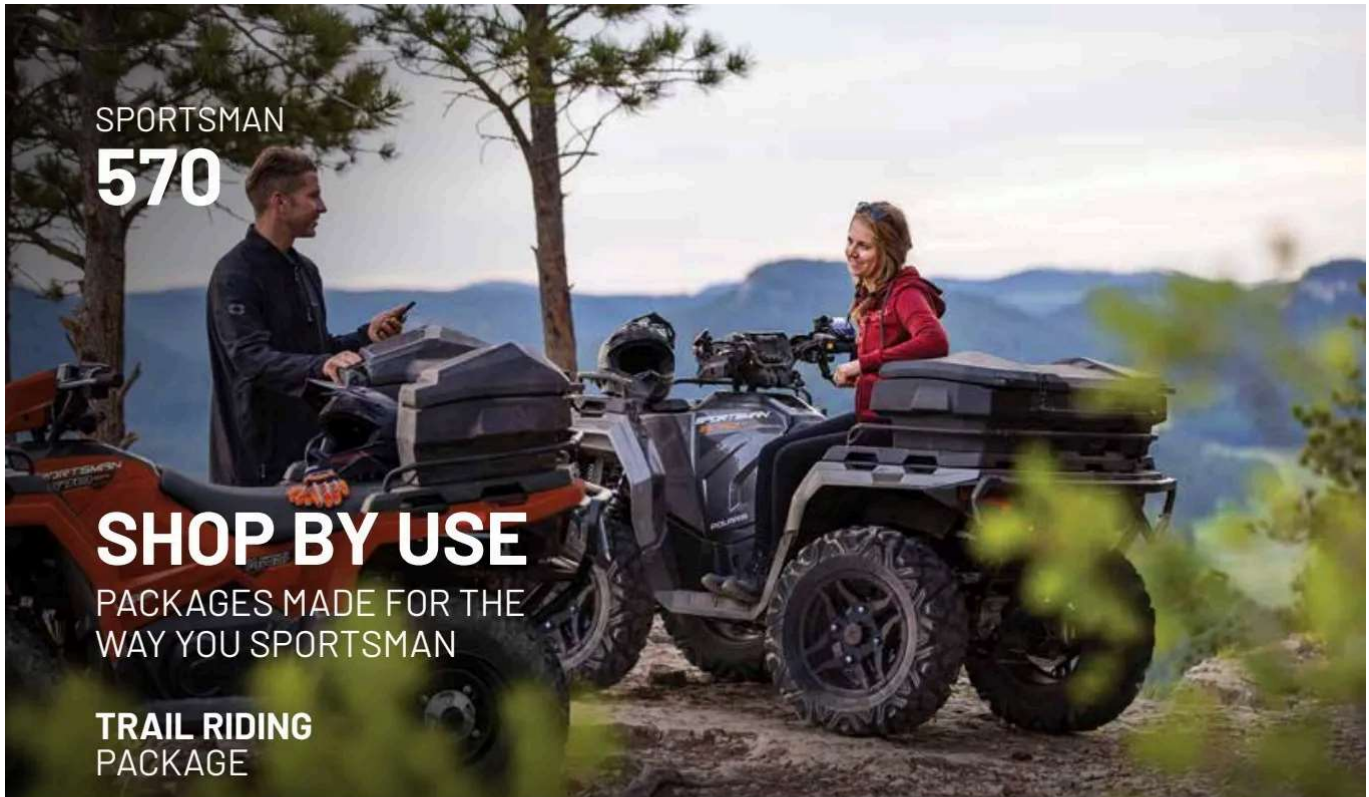

SPORTSMAN
570

SHOP BY USE
PACKAGES MADE FOR THE
WAY YOU SPORTSMAN

**TRAIL RIDING
PACKAGE**

- | | | | | | |
|-------------|-------------------------------|---------|--|---------|---|
| 2884844 | Trail Brushguard P. 13 | 2884987 | Audio Storage Box Remote P. 15 | 2882320 | Lightbar Harness P. 47 |
| 2890579-266 | Handguards P. 14 | 2891194 | Pod Bag P. 15 | 2879860 | LED Y-Harness P. 47 |
| 2889070 | Rear Power Harness P. 14 | 2891193 | Fender Bag P. 15 | 2883140 | Pro Armor Wheel & Tire Set:
Dual Threat/4202 P. 59 |
| 2885002 | Hand & Thumb Warmer Kit P. 14 | 2890878 |  Audio Cargo Box P. 20 | 2877385 | Lug Nuts P. 59 |
| 2891010 | Storage Bin Net P. 15 | 2883128 | RIGID® D-Series Pro Driving LED Light P. 46 | | |



**HUNT
PACKAGE**

- | | | | | | |
|---------|--|---------|--|---------|---|
| 2884850 | HD Front Brushguard with Hitch P. 13 | 2889864 | Rear Rack Extender P. 20 | 2882426 | Kolpin Stronghold Gun Boot L P. 50 |
| 2885002 | Hand & Thumb Warmer Kit P. 14 | 2890581 |  Semi-Rigid Storage Bag P. 21 | 2884846 | Kolpin Stronghold Auto-Latch Mount P. 50 |
| 2891010 | Storage Bin Net P. 15 | 2883123 | RIGID® SR-Series 25 cm Combo LED Light P. 47 | 2884119 |  Kolpin Rhino Grip Pro P. 51 |
| 2890617 |  Mid 39.4 cm Clear Windshield P. 16 | 2882320 | Lightbar Harness P. 47 | 2881360 | Pro Armor Wheel & Tire Set:
Attack 2.0/4205 P. 59 |
| | | | | 2877385 | Lug Nuts P. 59 |



**LANDOWNER
PACKAGE**

2884842 Front Utility Rack P. 13

2884850 HD Front Brushguard with Hitch P. 13

2891010 Storage Bin Net P. 15

2890617  Mid 39.4cm Clear Windshield P. 16

2889864 Rear Rack Extender P. 20

2890877  Open Cargo Box P. 20

2882385 Pro Armor Wheel & Tire Set:
Harvester/4204 P. 59

2877385 Lug Nuts P. 59



**WINTER
PACKAGE**

2884850 HD Front Brushguard with Hitch P. 13

2885002 Hand & Thumb Warmer Kit P. 14

2890616  Tall 48.9 cm Clear Windshield P. 16

2890876 Rear Cargo Box P. 20

2881424 Glacier Integrated Plow Mount P. 43

2879630  Glacier Pro Steel ATV Plow Frame P. 43

2880269 Glacier Pro Plow Blade - 168 cm Poly P. 43

2883123 RIGID® SR-Series 25 cm
Combo LED Light P. 46

2882320 Lightbar Harness P. 47



NEED A PLOW? P. 42

WINCHES



PRO HD SERIES

POLARIS PRO HD 1,588 KG WINCH

- Adds 1,588 kg of pulling capacity with Auto Stop Technology for plowing applications
- Rapid Rope Recovery recovers open cable 5x as fast as standard mode on other Polaris winches

» 2884834

SPORTSMAN 570 '21-25



HD SERIES

POLARIS HD 1,588 KG WINCH

- Adds 1,588 kg of pulling capacity with quick and easy installation
- Includes all components required for installation plus 15m of .5 cm premium high-strength synthetic rope

» 2884833

SPORTSMAN 570 '21-25



HD SERIES

POLARIS HD 1,134 KG WINCH TOP SELLER

- Adds 1,134 kg of pulling capacity with quick and easy installation
- Includes all components required for installation plus 15m of .5 cm high-strength steel cable

» 2884832

SPORTSMAN 570 '21-25



LEARN MORE P. 40

RACKS



FRONT UTILITY RACK TOP SELLER

- Tubular steel rack that attaches on top of front plastic rack providing protection and multiple tie down points
- 1.9 cm diameter matte black steel tube

» **2884842**
SPORTSMAN 570 '21-25, EXCEPT '21 AND PRIOR 6X6, X2 AND TOUR MODELS
DOES NOT WORK WITH KOLPIN STRONGHOLD AUTO-LATCH GUN MOUNT (2884846)



REAR UTILITY RACK TOP SELLER

- Replaces rear plastic rack with a strong flat steel rack with integrated tie down points
- Works with all Lock & Ride accessories, rack extenders, and gun mounts

» **2884843**
SPORTSMAN 570 '21-25



CARGO RACK

- Provides extra storage and a sturdy platform for securing items to the back of your ATV
- Replaces your stock rear bumper while increasing your rack size by 33%
- Virtually limitless number of tie-down points
- Has a steel matte black finish

» **2891223**
SPORTSMAN 570 '21-25
WILL NOT WORK WITH REAR BUMPER; SERVES AS REAR BUMPER / REAR CARGO RACK
OFF ROAD USE ONLY, NOT COMPATIBLE WITH LICENSE PLATE HOLDER



REAR RACK EXTENDER TOP SELLER

- Forms a 7.6 cm tall perimeter around the rear cargo rack to keep gear secure and keeping cargo from sliding off the rear platform
- Durable steel construction provides a sturdy tie down anchor for loose gear
- Compatible with Cargo Boxes and Rear Utility Rack

» **2884841**
SPORTSMAN 570 '21-25

PROTECTION



TRAIL BRUSHGUARD TOP SELLER

- Provides enhanced protection from brush and debris
- Has designated light bar holes and is compatible with winch and Body Armor

» **2884844**
SPORTSMAN 570 '21-25



REAR BRUSHGUARD TOP SELLER

- Protect your vehicle from brush, sticks, rocks and light bumps into solid objects
- Made of sturdy 3.2 cm steel tube with a matte black finish

» **2884847**
SPORTSMAN 570 '21-25
OFF ROAD USE ONLY, NOT COMPATIBLE WITH LICENSE PLATE HOLDER



HD FRONT BRUSHGUARD WITH HITCH

- Adds heavy-duty protection with a custom look
- Has designated light bar holes and is compatible with winch and Body Armor
- Standard front receiver hitch for additional functionality

» **2884850**
SPORTSMAN 570 '21-25



FRONT BOOT GUARDS

- Made from High Density Poly Ethylene (HDPE)
- Comes with two front guards, one for the left and right
- Protects the CV boot

» **STRUT A ARM • 2890059**
» **DUAL A ARM • 2890064**
SPORTSMAN 570 '21-25



REAR BOOT GUARDS

- Made from High Density Poly Ethylene (HDPE)
- Comes with two rear guards, one for the left and rights
- Protects the CV boot

» **2890866**
SPORTSMAN 570 '21-25



BODY ARMOR

- Provides extra protection to your ATV's full body and fenders

» **2884851**
SPORTSMAN 570 '21-25
FRONT BRUSHGUARD (2884850 OR 2884844) REQUIRED FOR INSTALLATION
DOES NOT WORK WITH KOLPIN STRONGHOLD AUTO-LATCH GUN MOUNT (2884846)



SPORTSMAN
570

COMFORT



HANDGUARDS

- Handguard Mount (2889341) is required when installing Polaris Handguards
- Does not fit with windshields

<input type="checkbox"/>	BRIGHT WHITE	2876883
<input checked="" type="checkbox"/>	BLACK <small>TOP SELLER</small>	2876846
<input type="checkbox"/>	INDY RED	2876845

» MOUNT • 2889341
SPORTSMAN 570 '21-25



LED LIGHT KIT

- Upgrade your standard headlights and pod lights to LEDs with this upgrade kit
- » 2884859
SPORTSMAN 570 '21-25
U.S. MODELS ONLY



HAND & THUMB WARMER KIT TOP SELLER

- Provides heat to grips and throttle and is easily installed by plugging into pod
 - Includes two heated grips and one throttle warmer
- » 2885002
SPORTSMAN 570 '21-25



HANDBAR MOUNTED MIRRORS TOP SELLER

- Enhances visibility of what's behind you for added safety
 - Sold as a pair
- »  2890578
» 2877222
SPORTSMAN 570 '21-25



ULTIMATE SERIES HANDGUARD KIT

- Protects riders from wind, snow, ice, branches, and other trail debris
- Larger design offers increased level of warmth and protection
- Ultimate Series Handguard Kit includes mounts

	POLARIS PURSUIT CAMO	2890579-587
<input checked="" type="checkbox"/>	BLACK	2890579-266

SPORTSMAN 570 '21-25
NOT COMPATIBLE WITH WINDSHIELDS



REAR POWER HARNESS

- Provides power to the rear of the ATV for electrical accessories including Rear Audio Storage Box
- » 2889070
SPORTSMAN 570 '21-25

AUDIO



AUDIO STORAGE BOX REMOTE

- Easily control the volume or switch to the next song on your Rear Audio Storage Box
 - Conveniently mounts to your ATV's handlebars
- » 2884987
SPORTSMAN 570 '21-25

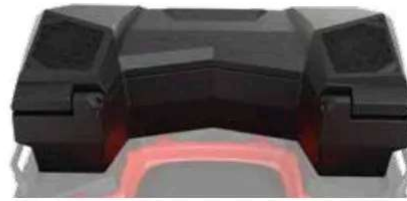

AUDIO CARGO BOX

- Dual 15.2 cm speakers by Rockford Fosgate that connect via Bluetooth
 - Mounts easily with Lock & Ride to the rear rack and is compatible with rack extenders, utility rack, and gun mount
 - Rest easy knowing that your speakers are protected with a sealed-lid container
 - Rear Power Harness required for installation (2889070)
- » 2890878
SPORTSMAN 570 '21-25

STORAGE



SEMI-RIGID STORAGE BAG

- Fits on either side of rear rack providing riders with more storage options
 - Mounts easily with Lock & Ride
 - Base is water-resistant to keep your gear dry
- » 2890581
SPORTSMAN 570 '21-25

STORAGE BIN NET

- Secure all of your small items and gear
 - Made of high quality EPDM rubber
- » 2891010
SPORTSMAN 570 '25

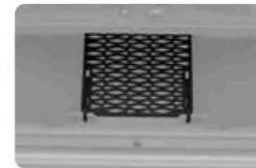

POD BAG

- Keep your essentials in reach with 2 liters of storage capacity
 - Mounts to the top of the light pod with HD Velcro
 - Semi-rigid construction and PU laminated EVA material keeps belongings protected from the elements
 - Compatible with windshields
- » 2891194
SPORTSMAN 570 '21-25



REAR CARGO BOX TOP SELLER

- Increase your storage with an extra 80.4 liters of dry, dust-proof storage
 - Mounts easily with Lock & Ride to the rear rack and is compatible with rack extenders, utility rack, and gun mount
 - Includes 2 padlock locations
- » 2890876
SPORTSMAN 570 '21-25



FENDER BAG

- Provides easy-access 8.3 liters of storage
 - Mounts to the front left fender with HD Velcro
 - Semi-rigid construction and PU laminated EVA material keeps belongings protected from the elements
- » 2891193
SPORTSMAN 570 '21-25



OPEN CARGO BOX

- Increase your storage with an extra 83.3 liters of convenient storage space
 - Mounts easily with Lock & Ride to the rear rack and is compatible with rack extenders, utility rack, and gun mount
 - Holds two 18.9 liter buckets with integrated grab handle to make it easy to carry and transport cargo
 - 12 convenient tie-down locations to secure cargo
- » 2890877
SPORTSMAN 570 '21-25



UNDERSEAT BAG

- Provides an extra 8.3 liters of storage capacity
 - Mounts directly under your seat via a Velcro wrap
 - Durable semi-rigid construction keeps items protected
- » 2889454
SPORTSMAN 570 '21-25



REAR COOLER BOX

- Increase your storage with an extra 43.5 liters of weather resistant cooler storage
 - Mounts easily with Lock & Ride to the rear rack and is compatible with rack extenders, utility rack, and gun mount
 - Integrated bottle opener and 2 padlock locations
- » 2890879
SPORTSMAN 570 '21-25



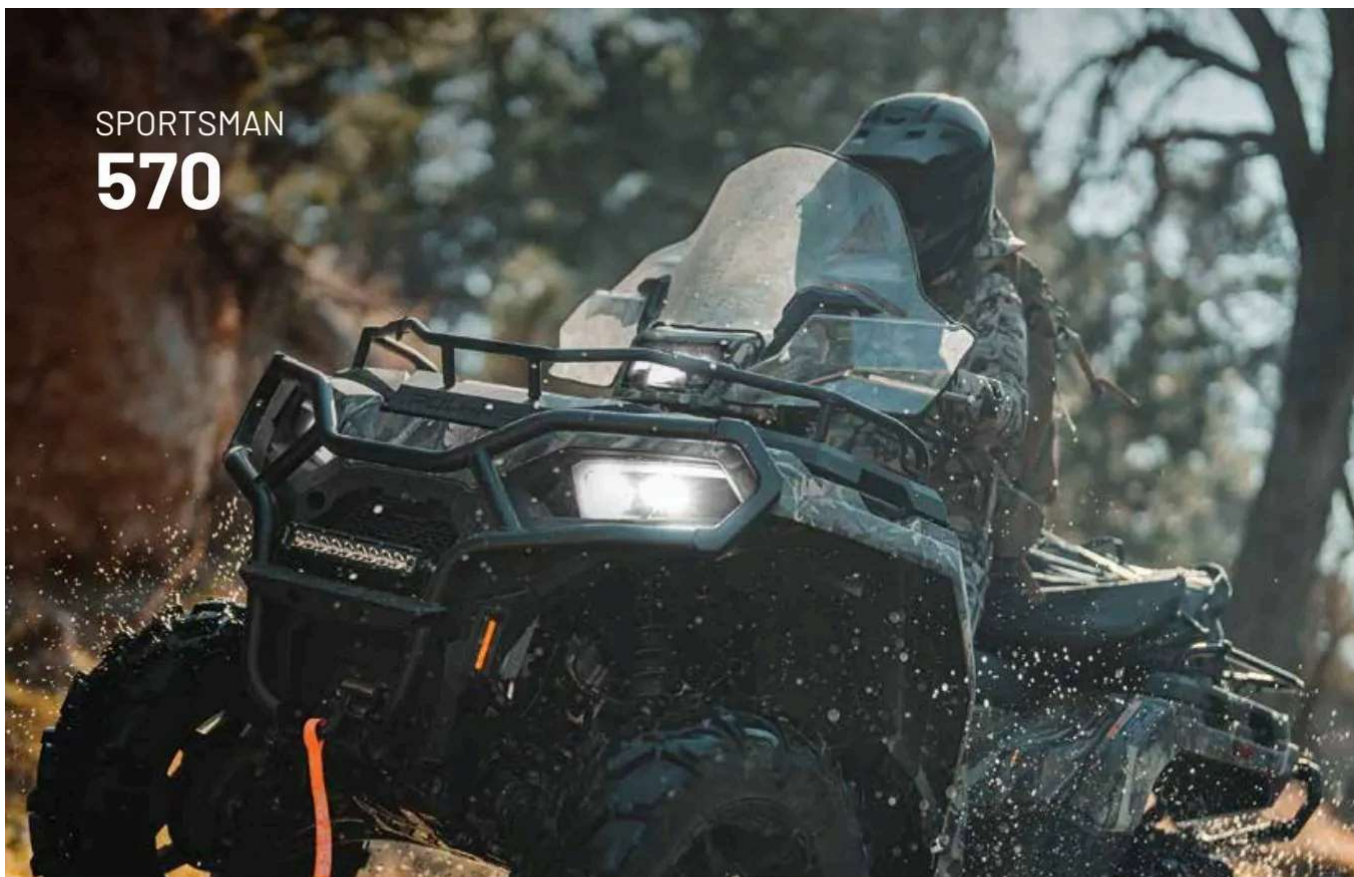

SPORTSMAN 570

WINDSHIELDS



TOP SELLER
TALL 48.9 CM CLEAR
2890616



TOP SELLER
MEDIUM 39.4 CM CLEAR
2890617



TALL 48.9 CM CLEAR
FOR RIDE COMMAND
EQUIPPED VEHICLES
2890618

WINDSHIELDS

- Lock & Ride technology allows for easy installation and removal in seconds without tools
- Poly windshields are flexible, impact-resistant, and provide long-term value over the life of your machine
- Two heights available for whatever coverage you prefer

SIZE	COLOR	PART #
TALL 48.9 CM	CLEAR	2890616
MEDIUM 39.4 CM	CLEAR	2890617

SPORTSMAN 570 '21-25

FOR RIDE COMMAND EQUIPPED VEHICLES

TALL 48.9 CM	CLEAR	2890618
--------------	-------	---------

SPORTSMAN 570 '23-25 WITH 7" DISPLAY INSTALLED





DO MORE

ACCESSORIES

570

650 / XP 1000
XP 1000 S

SPRABLER
XP 1000 S

MISCELLANEOUS
& YOUTH

WINCHES, PLOWS
& TRACKS

LIGHTING

CONNECTED
TECHNOLOGY

HUNT & COOLERS

WHEELS & TIRES
& TRAILERING



PLOWS P. 42



WHEELS & TIRES P. 54



LIGHTING P. 46



HUNT P. 50



INTRODUCING THE NEW

SPORTSMAN
570 X2
570 6x6
TOURING 570

SHOP BY USE
PACKAGES MADE FOR THE
WAY YOU SPORTSMAN

**TRAIL RIDING
PACKAGE**

- | | | | | | | | |
|-------------|--------------------------------|---------|------------------------------|---------|---|---------|--|
| 2890878 | Audio Cargo Box P. 20 | 2891194 | Pod Bag P. 21 | 2889908 | Passenger Handguards P. 22 | 2882320 | Lightbar Harness P. 47 |
| 2891010 | Storage Bin Net P. 21 | 2889866 | Rear Cargo Box Support P. 21 | 2889886 | Rear Power Harness P. 23 | 2879860 | LED Y-Harness P. 47 |
| 2884987 | Audio Storage Box Remote P. 21 | 2891193 | Fender Bag P. 21 | 2885002 | Hand & Thumb Warmer Kit P. 23 | 2883140 | Pro Armor Wheel & Tire Set: Dual Threat/4202 P. 59 |
| 2890579-266 | Handguards P. 23 | 2884844 | Trail Brushguard P. 22 | 2883128 | RIGID® D-Series Pro Driving LED Light P. 46 | 2877385 | Lug Nuts P. 59 |



**HUNT
PACKAGE**

- | | | | | | |
|---------|--------------------------------------|---------|--|---------|---|
| 2891010 | Storage Bin Net P. 21 | 2885002 | Hand & Thumb Warmer Kit P. 23 | 2882426 | Kolpin Stronghold Gun Boot L P. 50 |
| 2890581 | Semi-Rigid Storage Bag P. 21 | 2890617 | Mid 39.4 cm Clear Windshield P. 23 | 2884846 | Kolpin Stronghold Auto-Latch Mount P. 50 |
| 2889866 | Rear Cargo Box Support P. 21 | 2883123 | RIGID® SR-Series 25 cm Combo LED Light P. 47 | 2884119 | Rhino Grip Pro P. 51 |
| 2884850 | HD Front Brushguard with Hitch P. 22 | 2882320 | Lightbar Harness P. 47 | 2881360 | Pro Armor Wheel & Tire Set: Attack 2.0/4205 P. 59 |
| | | | | 2877385 | Lug Nuts P. 59 |



**LANDOWNER
PACKAGE**

- 2890877 **LR** Open Cargo Box P. 20
- 2884842 Front Utility Rack P. 20
- 2891000 Rear Rack Filler Plate P. 21

- 2891010 Storage Bin Net P. 21
- 2889866 Rear Cargo Box Support P. 21
- 2884850 HD Front Brushguard with Hitch P. 22

- 2890617 **LR** Mid 39.4 cm Clear Windshield P. 23
- 2882385 Pro Armor Wheel & Tire Set: Harvester/4204 P. 59
- 2877385 Lug Nuts P. 59



**WINTER
PACKAGE**

- 2890876 **LR** Cargo Box P. 20
- 2889866 Rear Cargo Box Support P. 21
- 2884850 HD Front Brushguard with Hitch P. 22
- 2885002 Hand & Thumb Warmer Kit P. 23

- 2889887 Driver Heated Seat P. 23
- 2889888 Passenger Heated Seat P. 23
- 2889906 Passenger Heated Grips P. 23
- 2890616 **LR** Tall 48.9 cm Clear Windshield P. 23
- 2881424 Glacier Integrated Plow Mount P. 43

- 2879630 **LR** Glacier Pro Steel ATV Plow Frame P. 43
- 2880269 Glacier Pro Plow Blade - 168 cm Poly P. 43
- 2883123 RIGID® SR-Series 10" Combo LED Light P. 47
- 2882320 Lightbar Harness P. 47



SPORTSMAN
570 X2
570 6x6
TOURING 570

STORAGE & RACKS

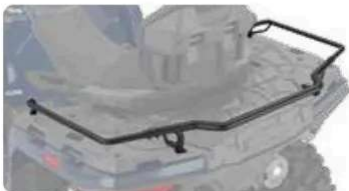

NEW
REAR RACK EXTENDER

- Forms a 7.3 cm tall perimeter around the rear cargo rack to keep gear secure
- Durable steel construction provides a sturdy tie down anchor for gear

» **2889864**
 SPORTSMAN TOURING 570 '25
 NOT COMPATIBLE WITH THE REAR CARGO BOX SUPPORT (2889866)
 STANDARD ON TOURING SP



NEW
LR OPEN CARGO BOX

- Increase your storage with an extra 83.3 liters of convenient storage space
- Mounts easily with Lock & Ride to the rear rack and is compatible with rack extenders, utility rack, and gun mount
- Holds two 18.9 liter buckets with integrated grab handle to make it easy to carry and transport cargo
- 12 convenient tie-down locations to secure cargo

» **2890877**
 SPORTSMAN TOURING 570 '25
 REAR CARGO BOX SUPPORT (2889866) REQUIRED, SOLD SEPARATELY



NEW
LR REAR CARGO BOX **TOP SELLER**

- Increase your storage with an extra 80.4 liters of dry, dust-proof storage
- Mounts easily with Lock & Ride to the rear rack and is compatible with rack extenders, utility rack, and gun mount
- Includes 2 padlock locations

» **2890876**
 SPORTSMAN TOURING 570 '25
 REAR CARGO BOX SUPPORT (2889866) REQUIRED, SOLD SEPARATELY



NEW
LR REAR COOLER BOX

- Increase your storage with an extra 43.5 liters of weather resistant cooler storage
- Mounts easily with Lock & Ride to the rear rack and is compatible with rack extenders, utility rack, and gun mount
- Integrated bottle opener and 2 padlock locations

» **2890879**
 SPORTSMAN TOURING 570 '25
 REAR CARGO BOX SUPPORT (2889866) REQUIRED, SOLD SEPARATELY



NEW
LR AUDIO CARGO BOX

- Dual 15.2 cm speakers by Rockford Fosgate that connect via Bluetooth
- Mounts easily with Lock & Ride to the rear rack and is compatible with rack extenders, utility rack, and gun mount
- Rest easy knowing that your speakers are protected with a sealed-lid container
- Rear Power Harness required for installation (2889070)

» **2890878**
 SPORTSMAN TOURING 570 '25
 REAR POWER HARNESS (2889866) REQUIRED, SOLD SEPARATELY
 REAR CARGO BOX SUPPORT (2889866) REQUIRED, SOLD SEPARATELY



NEW
FRONT UTILITY RACK **TOP SELLER**

- Tubular steel rack that attaches on top of front plastic rack providing protection and multiple tie down points
- 1.9 cm diameter matte black steel tube

» **2884842**
 SPORTSMAN X2 570 '25, SPORTSMAN 6X6 570 '25, SPORTSMAN TOURING 570 '25
 DOES NOT WORK WITH KOLPIN STRONGHOLD AUTO-LATCH GUN MOUNT (2884846)



NEW
LR SEMI-RIGID STORAGE BAG

- Fits on either side of rear rack providing riders with more storage options
- Mounts easily with Lock & Ride
- Base is water-resistant to keep your gear dry

» 2890581

SPORTSMAN TOURING 570 '25



NEW
PASSENGER SEAT BAG

- Straps mount around the rear passenger seat or doubles as a backpack
- Easily add and remove the bag at your convenience
- Semi-rigid compression molded design
- Tapered design allows access to rear storage bin

» 2890060

SPORTSMAN TOURING 570 '25



NEW
REAR RACK FILLER PLATE

- Fills the space between the driver seat and rear rack when the rear passenger seat is removed
- Fits in Rear Rack Storage Bin when not in use

» 2891000

SPORTSMAN TOURING SP 570 '25

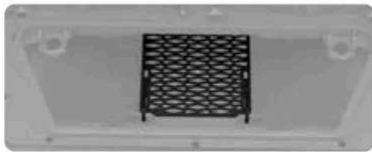

NEW
STORAGE BIN NET

- Secure all of your small items and gear
- Made of high quality EPDM rubber

» 2891010

SPORTSMAN TOURING 570 '25



NEW
REAR CARGO BOX SUPPORT TOP SELLER

- Allows mounting of cargo boxes when rear seat is installed

» 2889866

SPORTSMAN TOURING 570 '25

REQUIRED FOR TOURING 570

NOT COMPATIBLE WITH REAR BUMPER (2890001), REAR RACK EXTENDER (2899864) OR REAR CARGO RACK (2890037)



AUDIO STORAGE BOX REMOTE

- Easily control the volume or switch to the next song on your Rear Audio Storage Box
- Conveniently mounts to handlebars

» 2884987

SPORTSMAN TOURING 570 '25



NEW
FENDER BAG

- Provides easy-access 8.3 liters of storage
- Mounts to the front left fender with HD Velcro
- Semi-rigid construction and PU laminated EVA material keeps belongings protected from the elements

» 2891193

SPORTSMAN X2 570 '25, SPORTSMAN 6X6 570 '25, SPORTSMAN TOURING 570 '25



NEW
POD BAG

- Keep your essentials in reach with 2 Liters of storage capacity
- Mounts to the top of the light pod with HD Velcro
- Semi-rigid construction and PU Laminated EVA material keeps belongings protected from the elements
- Compatible with windshields

» 2891194

SPORTSMAN X2 570 '25, SPORTSMAN 6X6 570 '25, SPORTSMAN TOURING 570 '25

WINCHES



PRO HD SERIES

POLARIS PRO HD 1,588 KG WINCH

- Adds 1,588 kg of pulling capacity with Auto Stop Technology for plowing applications
- Rapid Rope Recovery recovers open cable 5x as fast as standard mode on other Polaris winches

» 2884834

SPORTSMAN X2 570 '25, SPORTSMAN 6X6 570 '25, SPORTSMAN TOURING 570 '25



HD SERIES

POLARIS HD 1,588 KG WINCH

- Adds 1,588 kg of pulling capacity with quick and easy installation
- Includes all components required for installation plus 15m of .5 cm premium high-strength synthetic rope

» 2884833

SPORTSMAN X2 570 '25, SPORTSMAN 6X6 570 '25, SPORTSMAN TOURING 570 '25



HD SERIES

POLARIS HD 1,134 KG WINCH TOP SELLER

- Adds 1,134 kg of pulling capacity with quick and easy installation
- Includes all components required for installation plus 15m of .5 cm high-strength steel cable

» 2884832

SPORTSMAN X2 570 '25, SPORTSMAN 6X6 570 '25, SPORTSMAN TOURING 570 '25



LEARN MORE P. 40



PROTECTION



TRAIL BRUSHGUARD TOP SELLER

- Provides enhanced protection from brush and debris
- Has designated light bar holes and is compatible with winch and Body Armor

» 2884844

SPORTSMAN X2 570 '25, SPORTSMAN 6X6 570 '25, SPORTSMAN TOURING 570 '25
STANDARD ON 6X6 NORDIC PRO TRIM



HD FRONT BRUSHGUARD WITH HITCH

- Adds heavy-duty protection with a custom look
- Has designated light bar holes and is compatible with winch and Body Armor
- Standard front receiver hitch for additional functionality

» 2884850

SPORTSMAN X2 570 '25, SPORTSMAN 6X6 570 '25, SPORTSMAN TOURING 570 '25



REAR BUMPER

- Durable 3.2 cm steel tube with a matte black finish
- Does not block access to the rear storage compartment

» 2890001

SPORTSMAN TOURING 570 '25
NOT COMPATIBLE WITH REAR CARGO BOX SUPPORT (2889866) OR REAR CARGO RACK (2890037)

OFF ROAD USE ONLY. NOT COMPATIBLE WITH LICENSE PLATE HOLDER



PASSENGER HANDGUARDS

- Two ATV passenger handguards
- Protection for hands in all riding conditions
- Mounting is quick/easy and included

» 2889908

SPORTSMAN TOURING SP 570 '25

COMFORT & CONVENIENCE



DRIVER HEATED SEAT TOP SELLER

- Plug and play seat installs easily
- Direct replacement for standard seat
- Integrated heat element, wiring harness and control switch

» 2889887
SPORTSMAN TOURING SP 570 '25



REAR POWER HARNESS

- Provides power to the rear of your ATV for easy access to hook up and run powered accessories

» 2889886
SPORTSMAN TOURING 570 '25
REQUIRED FOR AUDIO CARGO BOX (2890878), SOLD SEPARATELY



PASSENGER HEATED SEAT TOP SELLER

- Plug and play seat installs easily
- Direct replacement for standard seat
- Integrated heat element, wiring harness and control switch

» 2889888
SPORTSMAN TOURING SP 570 '25



HAND & THUMB WARMER KIT TOP SELLER

- Provides heat to grips and throttle and is easily installed by plugging into pod
- Includes two heated grips and one throttle warmer

» 2885002
SPORTSMAN X2 570 '25, SPORTSMAN 6X6 570 '25,
SPORTSMAN TOURING 570 '25
STANDARD ON NORDIC PRO TRIM



PASSENGER HEATED GRIPS TOP SELLER

- Keeps passenger hands warm in cold weather
- Includes all wiring and high/low switch

» 2889906
SPORTSMAN TOURING SP 570 '25



ULTIMATE SERIES HANDGUARD KIT

- Protects riders from wind, snow, ice, branches, and other trail debris
- Larger design offers increased level of warmth and protection
- Ultimate Series Handguard Kit includes mounts

■ POLARIS PURSUIT CAMO 2890579-587
■ BLACK 2890579-266

SPORTSMAN X2 570 '25, SPORTSMAN 6X6 570 '25,
SPORTSMAN TOURING 570 '25
NOT COMPATIBLE WITH WINDSHIELDS

WINDSHIELDS



TALL 48.9 CM CLEAR
2890616



MEDIUM 39.4 CM CLEAR
2890617



TALL 48.9 CM CLEAR
FOR RIDE COMMAND
EQUIPPED VEHICLES
2890618

LR WINDSHIELDS

- Lock & Ride technology allows for easy installation and removal in seconds without tools
- Poly windshields are flexible, impact-resistant, and provide long-term value over the life of your machine
- Two heights available for whatever coverage you prefer

SIZE	COLOR	PART #
TALL 48.9 CM	CLEAR	2890616
MEDIUM 39.4 CM	CLEAR	2890617

SPORTSMAN X2 570 '25, SPORTSMAN 6X6 570 '25, SPORTSMAN TOURING 570 '25

FOR RIDE COMMAND EQUIPPED VEHICLES

TALL 48.9 CM	CLEAR	2890618
--------------	-------	---------

SPORTSMAN X2 570 '25, SPORTSMAN 6X6 570 '25,
SPORTSMAN TOURING 570 '25 WITH 7" DISPLAY POWERED BY RIDE COMMAND INSTALLED



SPORTSMAN 570, 570 X2, 570 6X6, TOURING 570

MAINTENANCE PARTS & FLUIDS



POLARIS ENGINEERED PARTS AND OIL

have been validated and tested extensively, specifically for your vehicle. In order to maintain the peak performance of your Polaris vehicle only use official Polaris Engineered parts and oil.



We're taking the passion of our riders, workers, and outdoor enthusiasts to the next level with HD Parts. These Heavy Duty parts are engineered for riders who want greater durability and enhanced performance. HD Parts are designed and tested to handle greater wear and tear under all weather conditions.



A DRIVE BELT

- » 3211113
570
- » 3211229
570 EPS (PREMIUM, TRAIL), 570 TOURING, 570 X2, 570 6X6



B BRAKE PADS

- » FRONT & REAR • 2205606
570, 570 EPS, 570 TOURING L7E
- » REAR • 2205606
570 6X6
- » FRONT • 2202413
570 TOURING, 570 X2
- » REAR • 2204088
570 L7E
- » REAR • 2202412
570 TOURING, 570 X2
- » HD FRONT • 2208934
570 TOURING, 570 X2
- » FRONT • 2207835
570 6X6
- » HD REAR • 2208935
570 TOURING, 570 X2
- » FRONT • 2202412
570 L7E



C OIL FILTER

- » 2520799
- » HD • 2522498



D BATTERY

- » 4017419



E AIR FILTER

- » 7082101



F SPARK PLUGS

- » 570 • 3022662

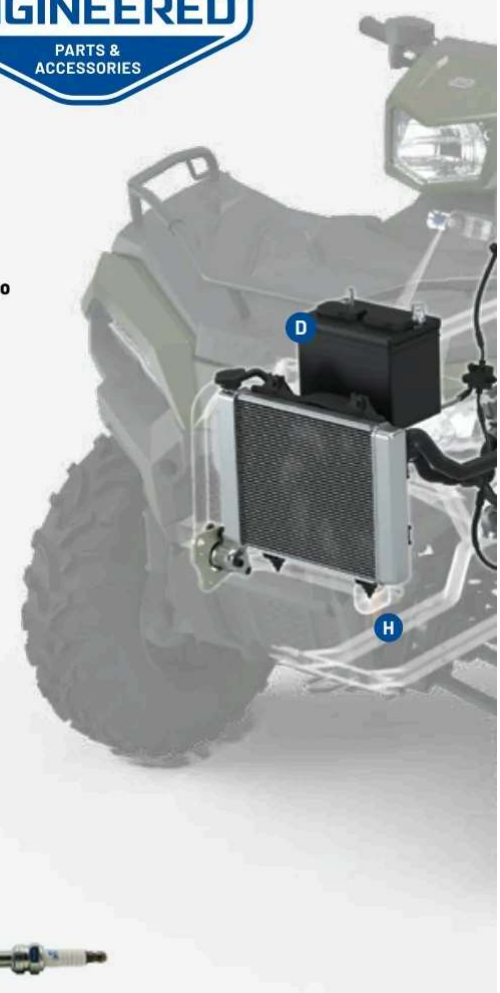

LOOKING FOR MORE SERVICE PARTS?

See P. 69 to learn how to find parts for your model.

2025 MAINTENANCE SCHEDULE*

BREAK-IN MAINTENANCE

FIRST 25 HRS | 500 MI / 800 KM

- ENGINE OIL & OIL FILTER CHANGE
- FRONT GEARCASE CHANGE FLUID
- BRAKE PADS INSPECT
REPLACE AS NEEDED
- BRAKE FLUID INSPECT
ADD AS NEEDED
- TRANSMISSION INSPECT FLUID
ADD AS NEEDED

12 MONTHS

100 HRS | 1,000 MI / 1,600 KM

- ENGINE OIL & OIL FILTER CHANGE
- AIR FILTER INSPECT
REPLACE AS NEEDED
- BATTERY TEST & CLEAN
REPLACE AS NEEDED
- BRAKE PADS INSPECT
REPLACE AS NEEDED
- DRIVE BELT INSPECT
REPLACE AS NEEDED
- FRONT GEARCASE INSPECT
- GENERAL LUBRICATION ALL FITTINGS, PIVOTS, CABLES, ETC.
- TRANSMISSION FLUID INSPECT

24 MONTHS

200 HRS | 2,000 MI / 3,200 KM

- ENGINE OIL & OIL FILTER CHANGE
- AIR FILTER INSPECT
REPLACE AS NEEDED
- BATTERY TEST & CLEAN
REPLACE AS NEEDED
- BRAKE PADS INSPECT
REPLACE AS NEEDED
- BRAKE FLUID CHANGE

ACCESSORIES

570

860 / XP1000
XP1000 S

SCRABBLER
XP1000 S

MISCELLANEOUS
& YOUTH

WINCHES, PLOWS
& TRACKS

LIGHTING

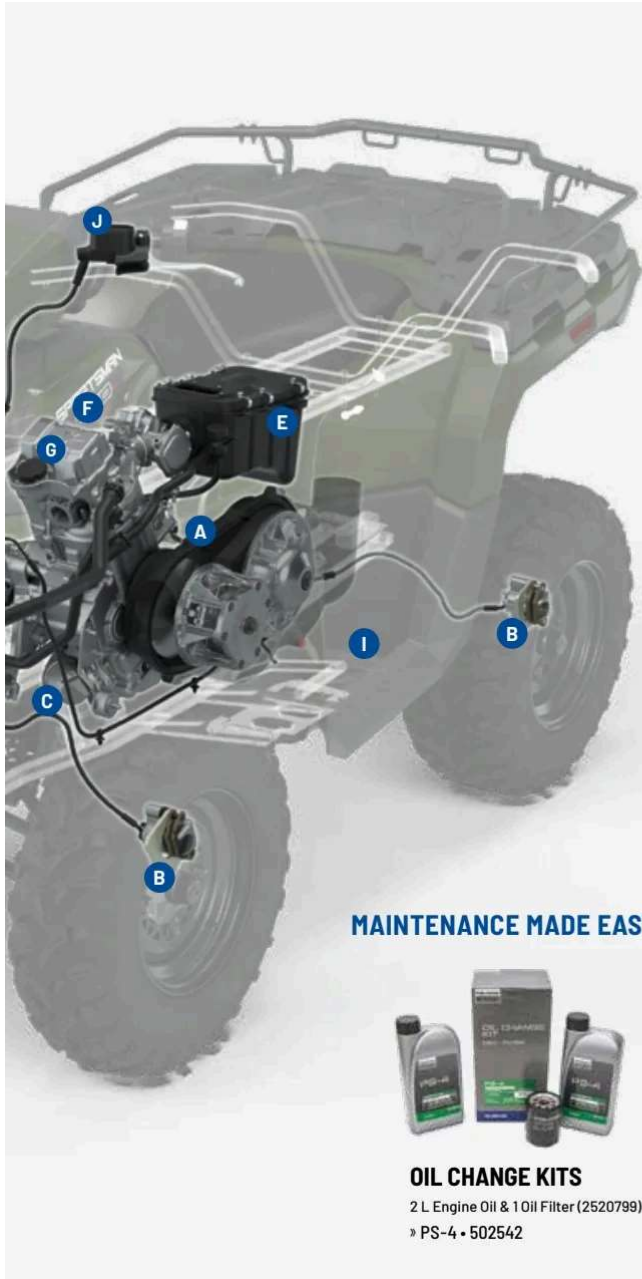

G
ENGINE OIL P. 64
 » PS-4 • 1 L • 502484
 » PS-4 • 4 L • 502485
 » PS-4 EXTREME • 1 L • 503220
 » PS-4 EXTREME • 4 L • 503221



H
DEMAND DRIVE FLUID
 For front gearcase
 » 1 L • 502563
 » 25 L • 502564
 » 200 L • 502565



I
AGL
 For transmission
 » 1 L • 502505
 » 25 L • 502507
 » 200 L • 502508



J
DOT 4 BRAKE FLUID
 » 250 ML • 502526

MAINTENANCE MADE EASY



OIL CHANGE KITS
 2 L Engine Oil & 10l Filter (2520799)
 » PS-4 • 502542



ALL-SEASON GREASE TUBE
 » 400 G • 502538

Claims made based off testing and performance of Polaris HD Parts against standard OEM parts made by Polaris and competitor brands under normal use. For more information regarding Polaris HD parts including vehicle compatibility, installation and maintenance, please contact your authorized Polaris ORV dealer.

36 MONTHS

FOR A COMPLETE MAINTENANCE SCHEDULE, CHECK YOUR OWNER'S MANUAL

300 HRS | 3,000 MI / 4,800 KM

- DRIVE BELT**
INSPECT
REPLACE AS NEEDED
- FRONT GEARCASE**
INSPECT
- GENERAL LUBRICATION**
ALL FITTINGS, PIVOTS, CABLES, ETC.
- TRANSMISSION FLUID**
INSPECT
- SPARK PLUGS**
INSPECT
REPLACE AS NEEDED

- ENGINE OIL & OIL FILTER**
CHANGE
- AIR FILTER**
INSPECT
REPLACE AS NEEDED
- BATTERY**
TEST & CLEAN
REPLACE AS NEEDED
- BRAKE PADS**
INSPECT
REPLACE AS NEEDED

- DRIVE BELT**
INSPECT
REPLACE AS NEEDED
- FRONT GEARCASE**
INSPECT
- GENERAL LUBRICATION**
ALL FITTINGS, PIVOTS, CABLES, ETC.
- TRANSMISSION FLUID**
INSPECT

CONNECTED TECHNOLOGY

HUNT & COOLERS

WHEELS & TIRES & TRAILERING

*This is a sample maintenance schedule. Please reference and use your owners manual for full maintenance and vehicle care.

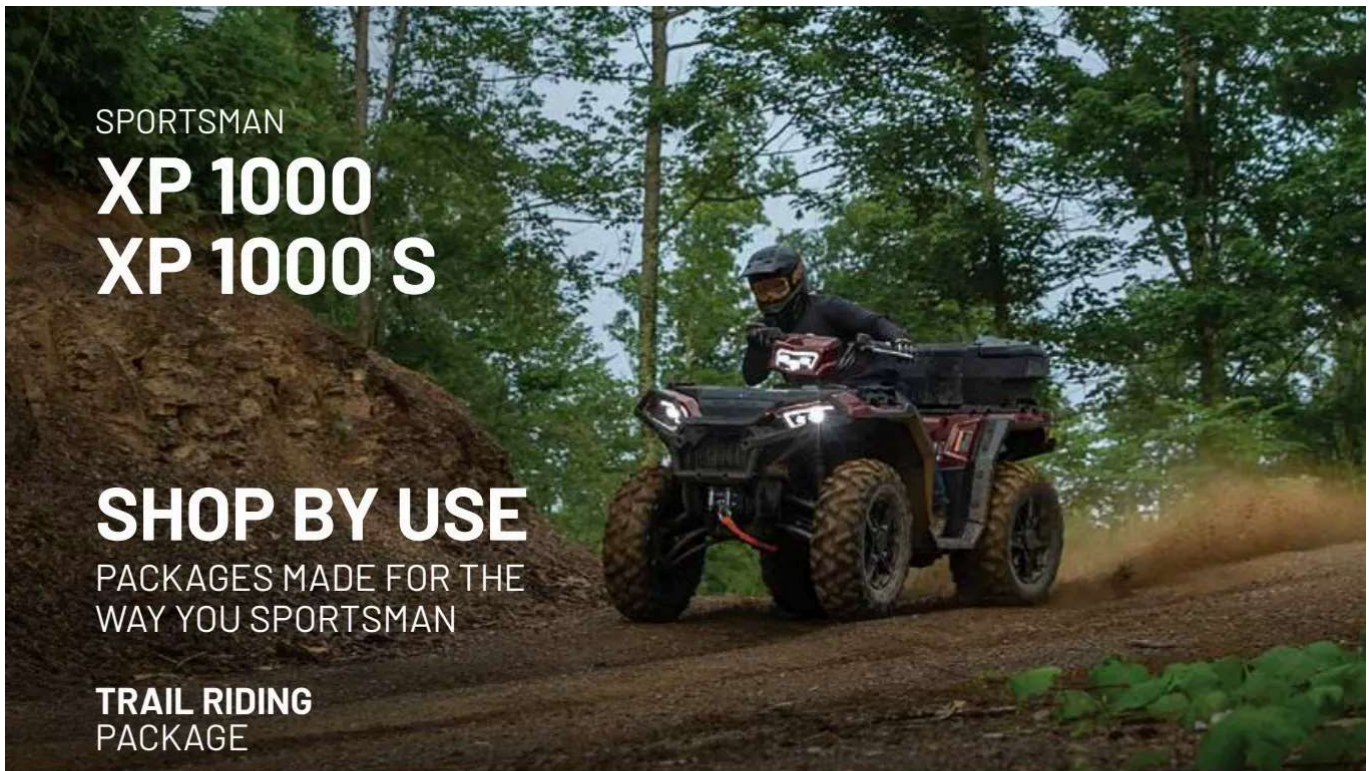

SPORTSMAN
XP 1000
XP 1000 S

SHOP BY USE
PACKAGES MADE FOR THE
WAY YOU SPORTSMAN

**TRAIL RIDING
PACKAGE**

- | | | | | | |
|---------|---|-------------|---|---------|---|
| 2882020 | Ultimate Series Front Brushguard P. 29 | 2890579-266 | Handguards P. 31 | 2882320 | Lightbar Harness P. 47 |
| 2882583 | Ultimate Series Rear Brushguard P. 29 | 2889071 | Rear Power Harness P. 31 | 2879860 | LED Y-Harness P. 47 |
| 2890878 |  Audio Cargo Box P. 31 | 2884987 | Audio Storage Box Remote P. 31 | 2883140 | Pro Armor Wheel & Tire Set:
Dual Threat/4202 P. 59 |
| 2885002 | Hand & Thumb Warmer Kit P. 31 | 2883128 | RIGID® D-Series Pro Driving LED Light P. 46 | 2877385 | Lug Nuts P. 59 |



**HUNT
PACKAGE**

- | | | | | | |
|---------|--|---------|--|---------|---|
| 2890617 |  Mid 39.4 cm Clear Windshield P. 28 | 2885002 | Hand & Thumb Warmer Kit P. 31 | 2884846 | Kolpin Stronghold Auto-Latch Mount P. 50 |
| 2882023 | Ultimate Series Rear Rack Extender 4' P. 29 | 2883123 | RIGID® SR-Series 25 cm Combo LED Light P. 47 | 2884119 |  Kolpin Rhino Grip Pro P. 51 |
| 2882020 | Ultimate Series Front Brushguard P. 29 | 2882320 | Lightbar Harness P. 47 | 2881360 | Pro Armor Wheel & Tire Set:
Attack 2.0/4205 P. 59 |
| 2882583 | Ultimate Series Rear Brushguard P. 29 | 2882426 | Kolpin Stronghold Gun Boot L P. 50 | 2877385 | Lug Nuts P. 59 |



LANDOWNER PACKAGE

- 2890617 Mid 39.4 cm Clear Windshield P. 28
- 2882583 Ultimate Series Rear Brushguard P. 29
- 2882385 Pro Armor Wheel & Tire Set: Harvester/4204 P. 59
- 2882020 Ultimate Series Front Brushguard P. 29
- 2890877 Open Cargo Box P. 30
- 2877385 Lug Nuts P. 59



WINTER PACKAGE

- 2890616 Tall 48.9 cm Clear Windshield P. 28
- 2885002 Hand & Thumb Warmer Kit P. 31
- 2880269 Glacier Pro Plow Blade - 168 cm Poly P. 43
- 2882020 Ultimate Series Front Brushguard P. 29
- 2881423 Integrated Plow Mount Frame Attachment P. 43
- 2883123 RIGID® SR-Series 25 cm Combo LED Light P. 47
- 2882583 Ultimate Series Rear Brushguard P. 29
- 2879630 Glacier Pro Steel ATV Plow Frame P. 43
- 2882320 Lightbar Harness P. 47
- 2890876 Rear Cargo Box P. 30



SPORTSMAN
XP 1000
XP 1000 S

NEED A PLOW? P. 42

WINCHES



LEARN MORE P. 40



PRO HD SERIES

POLARIS PRO HD 1,588 kg WINCH TOP SELLER

» 2889471

SPORTSMAN XP 1000 '15-25,
SPORTSMAN TOURING XP 1000 '15-25,



» 2883580

SPORTSMAN XP 1000 S '20-25



HD SERIES

POLARIS HD 1,588 KG WINCH

» 2889470

SPORTSMAN XP 1000 '15-25,
SPORTSMAN TOURING XP 1000 '15-25,



HD SERIES

POLARIS HD 1,134 KG WINCH

» 2889469

SPORTSMAN XP 1000 '15-25,
SPORTSMAN TOURING XP 1000 '15-25,

WINDSHIELDS

LR WINDSHIELDS

- Provides enhanced protection from the elements
- Easily installs and removes without tools utilizing Lock & Ride technology
- Improved mounting system for easier and quicker attachment and detachment



TOP SELLER
TALL 48.9 CM CLEAR
2890616



TOP SELLER
MEDIUM 39.4 CM CLEAR
2890617



TALL 48.9 CM CLEAR FOR RIDE COMMAND EQUIPPED VEHICLES
2890618

SIZE	COLOR	PART #
TALL 48.9 CM	CLEAR	2890616
MEDIUM 39.4 CM	CLEAR	2890617

SPORTSMAN XP 1000 S '21-25, SPORTSMAN XP 1000 '21-25

FOR RIDE COMMAND EQUIPPED VEHICLES

TALL 48.9 CM	CLEAR	2890618
--------------	-------	---------

SPORTSMAN XP 1000 '22-25
WITH 7" DISPLAY POWERED BY RIDE COMMAND INSTALLED

RACKS



ULTIMATE SERIES RACK EXTENDER 10.2 CM

- » **FRONT • 2882022**
SPORTSMAN 1000 T7-25,
SPORTSMAN XP 1000 S '20-25
- » **REAR • 2882023**
SPORTSMAN 1000 T7-25,
SPORTSMAN XP 1000 S '20-25
FITS WITH REAR CARGO BOX (2890876)



ULTIMATE SERIES RACK EXTENDER 17.8 CM

- » **FRONT • 2882024**
SPORTSMAN 1000 T7-25,
SPORTSMAN XP 1000 S '20-25
- » **REAR • 2882025**
SPORTSMAN 1000 T7-25,
SPORTSMAN XP 1000 S '20-25
DOES NOT FIT WITH REAR CARGO BOX (2890876)



FRONT RACK EXTENDER

- » **2879890**
SPORTSMAN 1000 TOURING '10-25
DOES NOT FIT WITH FRONT CARGO BOX (2877951)



ULTIMATE SERIES MOVABLE TIE-DOWN POINTS

- Comes as pair
- » **FRONT & REAR • 2882270**
SPORTSMAN 1000 T7-25



ULTIMATE SERIES STEEL RACK

- » **FRONT • 2883257**
SPORTSMAN 1000 T7-25,
SPORTSMAN XP 1000 S '20-25
- » **REAR • 2883258**
SPORTSMAN 1000 T7-25,
SPORTSMAN XP 1000 S '20-25

PROTECTION



ULTIMATE SERIES BODY ARMOR

- Securely mounts to Ultimate Series Front Brushguard (2882020)
- Comes as pair
- » **2882090**
SPORTSMAN 1000 T7-25
DOES NOT WORK WITH KOLPIN STRONGHOLD GUN BOOT XL (2882036)



ULTIMATE SERIES BRUSHGUARD TOP SELLER

- Quick installation to the integrated mounting tubes on the vehicle using wedge-style expansion anchor mounts
- Attach the Ultimate Series Body Armor to the Front Brushguard to provide the ultimate protection for the front fenders
- » **FRONT • 2882020**
SPORTSMAN 1000 T7-25,
SPORTSMAN XP 1000 S '20-25
- » **REAR • 2882583**
SPORTSMAN 1000 T7-25,
SPORTSMAN XP 1000 S '20-25



TOURING XP BRUSHGUARD

- Adds heavy-duty protection and a custom look
- » **FRONT • 2878709**
SPORTSMAN 1000 TOURING '10-25
- » **REAR • 2878324**
SPORTSMAN 1000 TOURING '10-25



STORAGE



REAR CARGO BOX TOP SELLER

- Increase your storage with an extra 80.4 liters of dry, dust-proof storage
- Mounts easily with Lock & Ride to the rear rack and is compatible with rack extenders and gun mount
- Includes 2 padlock locations

» 2890876
SPORTSMAN 1000 '17-25, SPORTSMAN XP 1000 S '20-25
WILL NOT FIT WHEN ULTIMATE SERIES STEEL RACK IS INSTALLED



OPEN CARGO BOX

- Increase your storage with an extra 83.3 liters of convenient storage space
- Mounts easily with Lock & Ride to the rear rack and is compatible with rack extenders and gun mount
- Holds 2, 18.9-liter buckets with integrated grab handle to make it easy to carry and transport cargo
- 12 convenient tie-down locations to secure cargo
- Includes 2 padlock locations

» 2890877
SPORTSMAN 1000 '17-25, SPORTSMAN XP 1000 S '20-25
WILL NOT FIT WHEN ULTIMATE SERIES STEEL RACK IS INSTALLED



REAR COOLER BOX

- Increase your storage with an extra 43.5 liters of weather-resistant cooler storage space
- Mounts easily with Lock & Ride to the rear rack and is compatible with rack extenders and gun mount
- Integrated bottle opener and 2 padlock locations

» 2890879
SPORTSMAN 1000 '17-25, SPORTSMAN XP 1000 S '20-25
WILL NOT FIT WHEN ULTIMATE SERIES STEEL RACK IS INSTALLED



POD BAG

- Keep your essentials in reach with 2 liters of storage capacity
- Mounts to the top of the light pod with HD Velcro
- Semi-rigid construction and PU laminated EVA material keeps belongings protected from the elements
- Compatible with windshields

» 2891194
SPORTSMAN 1000 '21-25



SEMI-RIGID STORAGE BAG

- Fits on either side of rear rack providing riders with more storage options
- Mounts easily with Lock & Ride
- Base is water-resistant to keep your gear dry

» 2890581
SPORTSMAN 1000 '17-25, SPORTSMAN XP 1000 S '20-25



ULTIMATE SERIES READY PACK

- Keep your trail essentials at the ready with this easy-to-access, weather-resistant storage compartment

» 2882271
SPORTSMAN 1000 '17-25



FRONT CARGO BOX

» 2877951
SPORTSMAN 1000 TOURING '10-25
FRONT RACK EXTENDER CANNOT BE INSTALLED AT THE SAME TIME AS FRONT CARGO BOX



REAR STORAGE BOX

» 2878000
SPORTSMAN 1000 TOURING '10-25
SLIGHT INTERFERENCE WITH SPORTSMAN TOURING 550 '11-14 PASSENGER HANDLES
DOES NOT FIT '21 TOURING MODELS

AUDIO



AUDIO STORAGE BOX REMOTE

- Easily control the volume or switch to the next song on your Rear Audio Storage Box
- Conveniently mounts to your ATV's handlebars

» 2884987

SPORTSMAN 1000 '17-25, SPORTSMAN XP 1000 S '20-25



AUDIO CARGO BOX

- Dual 15.2 cm speakers by Rockford Fosgate that connect via Bluetooth
- Mounts easily with Lock & Ride to the rear rack and is compatible with rack extenders and gun mount
- Speakers are protected with a sealed-lid container

» 2890878

SPORTSMAN 1000 '17-25, SPORTSMAN XP 1000 S '20-25
REAR POWER HARNESS (2889071) IS REQUIRED, SOLD SEPARATELY



REAR POWER HARNESS

- Provides power to the rear of the ATV for electrical accessories including Rear Audio Storage Box

» 2889071

SPORTSMAN XP 1000 '17-25, SPORTSMAN XP 1000 S '20-25

COMFORT



2890578



2877222

HANDLEBAR MOUNTED MIRRORS TOP SELLER

- Enhances visibility of what's behind you for added safety
- Sold as a pair

» 2890578

» 2877222

SPORTSMAN 1000 TOURING '10-25, SPORTSMAN 1000 '09-25, SPORTSMAN XP 1000 S '20-25



HAND & THUMB WARMER KIT TOP SELLER

- Provides heat to grips and throttle and is easily installed by plugging into pod
- Includes two heated grips and one throttle warmer

» KIT • 2885002

SPORTSMAN XP 1000 S '20-25, SPORTSMAN 1000 '15-25, SPORTSMAN TOURING 1000 '15-25

» JUMPER HARNESS • 2890685

REQUIRED FOR THE FOLLOWING MODELS: SPORTSMAN XP 1000 S '20, SPORTSMAN 1000 '15-20, SPORTSMAN TOURING 1000 '15-25



ULTIMATE SERIES HANDGUARD KIT

- Larger design offers increased protects from wind, snow, ice, branches, and other trail debris
- Mounts included

- POLARIS PURSUIT CAMO 2890579-587
- BLACK 2890579-266

SPORTSMAN 1000 TOURING '10-25, SPORTSMAN 1000 '09-25, SPORTSMAN XP 1000 S '20-25
NOT COMPATIBLE WITH WINDSHIELDS



HANDGUARDS

- Handguard Mount (2889341) is required when installing Polaris Handguards

SPORTSMAN 1000 TOURING '10-25, SPORTSMAN 1000 '09-25, SPORTSMAN XP 1000 S '20-25

NOT COMPATIBLE WITH WINDSHIELDS

- BRIGHT WHITE 2876883
- BLACK TOP SELLER 2876846
- INDY RED 2876845

» MOUNT • 2889341



DO MORE



PLOWS P. 42



WHEELS & TIRES P. 54



LIGHTING P. 46



HUNT P. 50

SPORTSMAN XP 1000 / XP 1000 S

MAINTENANCE PARTS & FLUIDS



POLARIS ENGINEERED PARTS AND OIL have been validated and tested extensively, specifically for your vehicle. In order to maintain the peak performance of your Polaris vehicle only use official Polaris Engineered parts and oil.



We're taking the passion of our riders, workers, and outdoor enthusiasts to the next level with HD Parts. These Heavy Duty parts are engineered for riders who want greater durability and enhanced performance. HD Parts are designed and tested to handle greater wear and tear under all weather conditions.

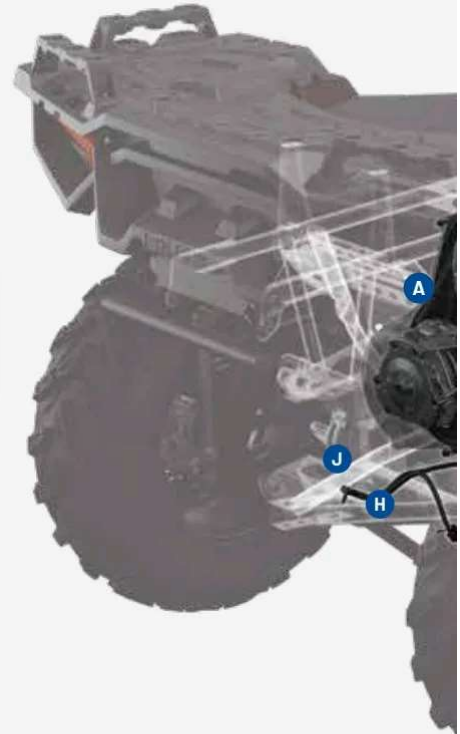

A DRIVE BELT
 » 3212329
 » **HD** • 3212331



B BRAKE PADS
 » FRONT & REAR • 2205606
 XP 1000 TOURING
 » FRONT • 2205606
 XP 1000, XP 1000 S
 » REAR • 2208936
 XP 1000 S
 » REAR • 2204088
 XP 1000



C OIL FILTER
 » 2520799
 » **HD** • 2522498



D BATTERY
 » 4019243



E AIR FILTER
 » 7082101



F SPARK PLUGS
 » 3022553

LOOKING FOR MORE SERVICE PARTS?

See P. 69 to learn how to find parts for your model.

MAINTENANCE SCHEDULE*

BREAK-IN MAINTENANCE	6 MONTHS	12 MONTHS	18 MONTHS
FIRST 25 HRS 250 MI / 400 KM	50 HRS 500 MI / 800 KM	100 HRS 1,000 MI / 1,600 KM	150 HRS 1,500 MI / 2,400 KM
ENGINE OIL & OIL FILTER CHANGE	DRIVE BELT INSPECT REPLACE AS NEEDED	AIR FILTER INSPECT REPLACE AS NEEDED	DRIVE BELT INSPECT REPLACE AS NEEDED
AIR FILTER INSPECT REPLACE AS NEEDED	AIR FILTER INSPECT REPLACE AS NEEDED	ALTERNATOR BELT INSPECT REPLACE AS NEEDED	AIR FILTER INSPECT REPLACE AS NEEDED
FRONT & REAR GEARCASE INSPECT FLUID	BATTERY TEST & CLEAN REPLACE AS NEEDED	BATTERY TEST & CLEAN REPLACE AS NEEDED	BATTERY TEST & CLEAN REPLACE AS NEEDED
TRANSMISSION CHANGE FLUID	GENERAL LUBRICATION ALL FITTINGS, PIVOTS, CABLES, ETC.	ENGINE OIL & OIL FILTER CHANGE	GENERAL LUBRICATION ALL FITTINGS, PIVOTS, CABLES, ETC.
		FRONT & REAR GEARCASE CHANGE FLUID	
		BATTERY TEST & CLEAN REPLACE AS NEEDED	
		SPARK PLUGS INSPECT REPLACE AS NEEDED	
		TRANSMISSION INSPECT FLUID	
		DRIVE BELT INSPECT REPLACE AS NEEDED	

G
ENGINE OIL P. 64
» PS-4 • 1 L • 502484
» PS-4 • 4 L • 502485
» PS-4 EXTREME • 1 L • 503220
» PS-4 EXTREME • 4 L • 503221

H
ANGLE DRIVE FLUID 80W/140
For rear gearcase
» 1 L • 503320
» 25 L • 503318
» 200 L • 503317

I
DEMAND DRIVE FLUID
For front gearcase
» 1 L • 502563
» 25 L • 502564
» 200 L • 502565

J
AGL
For transmission
» 1 L • 502505
» 25 L • 502507
» 200 L • 502508

K
DOT 4 BRAKE FLUID
» 250 ML • 502526

MAINTENANCE MADE EASY

OIL CHANGE KITS
2 L Engine Oil & 1 Oil Filter (2520799)
» PS-4 • 502542

ALL-SEASON GREASE TUBE
» 400 G • 502538

Claims made based off testing and performance of Polaris HD Parts against standard OEM parts made by Polaris and competitor brands under normal use. For more information regarding Polaris HD parts including vehicle compatibility, installation and maintenance, please contact your authorized Polaris ORV dealer.

24 MONTHS	30 MONTHS	36 MONTHS	FOR A COMPLETE MAINTENANCE SCHEDULE, CHECK YOUR OWNER'S MANUAL
<p>200 HRS 2,000 MI / 3,200 KM</p> <ul style="list-style-type: none"> AIR FILTER INSPECT REPLACE AS NEEDED ALTERNATOR BELT INSPECT REPLACE AS NEEDED BATTERY TEST & CLEAN REPLACE AS NEEDED BRAKE PADS INSPECT REPLACE AS NEEDED BRAKE FLUID CHANGE DRIVE BELT INSPECT REPLACE AS NEEDED ENGINE OIL & OIL FILTER CHANGE FRONT & REAR GEARCASE CHANGE FLUID GENERAL LUBRICATION ALL FITTINGS, PIVOTS, CABLES, ETC. SPARK PLUGS INSPECT REPLACE AS NEEDED TRANSMISSION INSPECT FLUID 	<p>250 HRS 2,500 MI / 4,000 KM</p> <ul style="list-style-type: none"> DRIVE BELT INSPECT REPLACE AS NEEDED AIR FILTER INSPECT REPLACE AS NEEDED BATTERY TEST & CLEAN REPLACE AS NEEDED GENERAL LUBRICATION ALL FITTINGS, PIVOTS, CABLES, ETC. 	<p>300 HRS 3,000 MI / 4,800 KM</p> <ul style="list-style-type: none"> AIR FILTER INSPECT REPLACE AS NEEDED ALTERNATOR BELT INSPECT REPLACE AS NEEDED BATTERY TEST & CLEAN REPLACE AS NEEDED BRAKE PADS INSPECT REPLACE AS NEEDED DRIVE BELT INSPECT REPLACE AS NEEDED ENGINE OIL & OIL FILTER CHANGE FRONT & REAR GEARCASE CHANGE FLUID GENERAL LUBRICATION ALL FITTINGS, PIVOTS, CABLES, ETC. SPARK PLUGS INSPECT REPLACE AS NEEDED TRANSMISSION INSPECT FLUID 	

*This is a sample maintenance schedule. Please reference and use your owners manual for full maintenance and vehicle care.



SCRAMBLER XP 1000 S

WINCHES



LEARN MORE P. 40



PRO HD SERIES

POLARIS PRO HD 1,588 KG WINCH TOP SELLER
 » 2883580 SCRAMBLER XP 1000 S '20-25
 » 2889471 SCRAMBLER XP 1000 '14-18



HD SERIES

POLARIS HD 1,588 KG WINCH
 » 2889470 SCRAMBLER XP 1000 '14-18



HD SERIES

POLARIS HD 1,134 KG WINCH
 » 2889469 SCRAMBLER XP 1000 '14-18

RACKS/STORAGE



LARGE REAR RACK

» 2879139
 SCRAMBLER XP 1000 S '20-25, SCRAMBLER XP 1000 '14-18
 NOT COMPATIBLE WITH OGIO BAG (2879925)



OGIO BAG

» 2879925
 SCRAMBLER XP 1000 S '20-25, SCRAMBLER XP 1000 '14-18
 NOT COMPATIBLE WITH LARGE REAR RACK (2879139)



ACCESSORIES

570

860 / XP 1000
XP 1000 S

SCRAMBLER
XP 1000 S

MISCELLANEOUS
& YOUTH

WINCHES, PLOW
& TRACKS

LIGHTING

CONNECTED
TECHNOLOGY

HUNT & COOLERS

WHEELS & TIRES
& TRAILERING

PROTECTION

NEW
**ULTIMATE SPORT SERIES
FRONT BRUSHGUARD**

» 2883595-458
SCRAMBLER XP 1000 S '20-25



COMFORT



HANDGUARD

- Handguard Mount (2889341) is required when installing Polaris Handguards
- Does not fit with windshields

<input type="checkbox"/>	BRIGHT WHITE	2876883
<input checked="" type="checkbox"/>	BLACK TOP SELLER	2876846
<input type="checkbox"/>	INDY RED	2876845

SCRAMBLER XP 1000 S '20-25,
SCRAMBLER XP 1000 '14-18

» 2889341 • MOUNT



ULTIMATE SERIES HANDGUARD KIT

- Protects riders from wind, snow, ice, branches, and other trail debris
- Larger design offers increased level of warmth and protection
- Ultimate Series Handguard Kit includes mounts

» 2890579-266

SCRAMBLER XP 1000 S '20-25, SCRAMBLER XP 1000 '14-18
NOT COMPATIBLE WITH WINDSHIELDS

SPORTSMAN SCRAMBLER XP 1000 S

MAINTENANCE PARTS & FLUIDS



POLARIS ENGINEERED PARTS AND OIL have been validated and tested extensively, specifically for your vehicle. In order to maintain the peak performance of your Polaris vehicle only use official Polaris Engineered parts and oil.



We're taking the passion of our riders, workers, and outdoor enthusiasts to the next level with HD Parts. These Heavy Duty parts are engineered for riders who want greater durability and enhanced performance. HD Parts are designed and tested to handle greater wear and tear under all weather conditions.

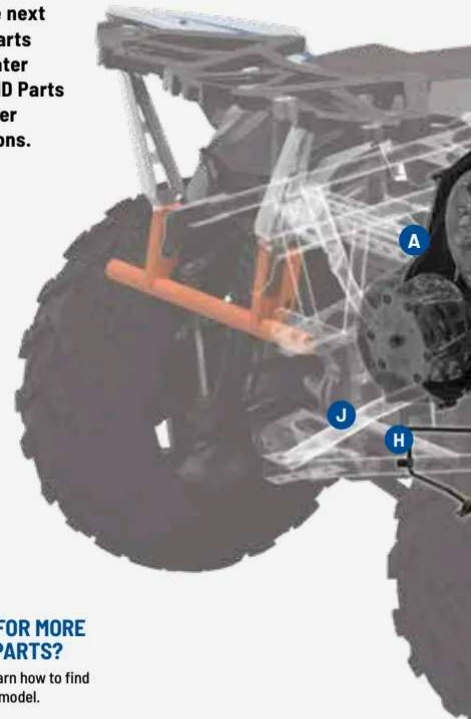

A DRIVE BELT
 » 3212329
 » **HD** • 3212331



B BRAKE PADS
 » FRONT • 2205606
 » REAR • 2204088



C OIL FILTER
 » 2520799
 » **HD** • 2522498



D BATTERY
 » 4018063
 SCRAMBLER XP 1000 S TRACTOR
 » 4019243
 SCRAMBLER XP 1000 S EU



E AIR FILTER
 » 7082101



F SPARK PLUGS
 » 3022553
 SCRAMBLER XP 1000 S

LOOKING FOR MORE SERVICE PARTS?
 See P. 69 to learn how to find parts for your model.

MAINTENANCE SCHEDULE*

BREAK-IN MAINTENANCE	6 MONTHS	12 MONTHS	18 MONTHS
FIRST 25 HRS 250 MI / 400 KM	50 HRS 500 MI / 800 KM	100 HRS 1,000 MI / 1,600 KM	150 HRS 1,500 MI / 2,400 KM
ENGINE OIL & OIL FILTER CHANGE	BRAKE PADS INSPECT REPLACE AS NEEDED	AIR FILTER INSPECT REPLACE AS NEEDED	BRAKE PADS INSPECT REPLACE AS NEEDED
AIR FILTER INSPECT REPLACE AS NEEDED	AIR FILTER INSPECT REPLACE AS NEEDED	BRAKE PADS INSPECT REPLACE AS NEEDED	AIR FILTER INSPECT REPLACE AS NEEDED
FRONT & REAR GEARCASE CHANGE FLUID	DRIVE BELT INSPECT REPLACE AS NEEDED	ENGINE OIL & OIL FILTER CHANGE	DRIVE BELT INSPECT REPLACE AS NEEDED
TRANSMISSION CHANGE FLUID	BATTERY TEST & CLEAN REPLACE AS NEEDED	FRONT & REAR GEARCASE CHANGE FLUID	BATTERY TEST & CLEAN REPLACE AS NEEDED
	GENERAL LUBRICATION ALL FITTINGS, PIVOTS, CABLES, ETC.	GENERAL LUBRICATION ALL FITTINGS, PIVOTS, CABLES, ETC.	GENERAL LUBRICATION ALL FITTINGS, PIVOTS, CABLES, ETC.
		SPARK PLUGS INSPECT REPLACE AS NEEDED	
		TRANSMISSION CHANGE FLUID	



MAINTENANCE MADE EASY



OIL CHANGE KITS

2 L Engine Oil & 1 Oil Filter (2520799)
» PS-4 • 502542



G ENGINE OIL P. 64

- » PS-4 • 1 L • 502484
- » PS-4 • 4 L • 502485
- » PS-4 EXTREME • 1 L • 503220
- » PS-4 EXTREME • 4 L • 503221



H ANGLE DRIVE FLUID 80W/140

For rear gearcase
» 1 L • 503320
» 25 L • 503318
» 200 L • 503317



I DEMAND DRIVE FLUID

For front gearcase
» 1 L • 502563
» 25 L • 502564
» 200 L • 502565



J AGL

For transmission
» 1 L • 502505
» 25 L • 502507
» 200 L • 502508



K DOT 4 BRAKE FLUID

» 250 ML • 502526



ALL-SEASON GREASE TUBE

» 400 G • 502538

Claims made based off testing and performance of Polaris HD Parts against standard OEM parts made by Polaris and competitor brands under normal use. For more information regarding Polaris HD parts including vehicle compatibility, installation and maintenance, please contact your authorized Polaris ORV dealer.

24 MONTHS

200 HRS | 2,000 MI / 3,200 KM

- AIR FILTER**
INSPECT
REPLACE AS NEEDED
- BRAKE PADS / BRAKE FLUID**
INSPECT / CHANGE
REPLACE AS NEEDED / NA
- ENGINE OIL & OIL FILTER**
CHANGE
- FRONT & REAR GEARCASE**
CHANGE FLUID
- GENERAL LUBRICATION**
ALL FITTINGS, PIVOTS,
CABLES, ETC.
- SPARK PLUGS**
INSPECT
REPLACE AS NEEDED
- TRANSMISSION**
CHANGE FLUID

30 MONTHS

250 HRS | 2,500 MI / 4,000 KM

- BRAKE PADS**
INSPECT
REPLACE AS NEEDED
- AIR FILTER**
INSPECT
REPLACE AS NEEDED
- DRIVE BELT**
INSPECT
REPLACE AS NEEDED
- BATTERY**
TEST & CLEAN
REPLACE AS NEEDED
- GENERAL LUBRICATION**
ALL FITTINGS, PIVOTS,
CABLES, ETC.

36 MONTHS

300 HRS | 3,000 MI / 4,800 KM

- AIR FILTER**
INSPECT
REPLACE AS NEEDED
- BRAKE PADS**
INSPECT
REPLACE AS NEEDED
- ENGINE OIL & OIL FILTER**
CHANGE
- FRONT & REAR GEARCASE**
CHANGE FLUID
- GENERAL LUBRICATION**
ALL FITTINGS, PIVOTS,
CABLES, ETC.
- SPARK PLUGS**
INSPECT
REPLACE AS NEEDED
- TRANSMISSION**
CHANGE FLUID

FOR A COMPLETE MAINTENANCE SCHEDULE, CHECK YOUR OWNER'S MANUAL

*This is a sample maintenance schedule. Please reference and use your owners manual for full maintenance and vehicle care.

MISCELLANEOUS

ACCESSORIES



CHAINSAW MOUNT

- Heavy-duty, black powder-coated metal bracket is designed to transport your chain saw securely
 - With Lock & Ride technology, it can be secured to the outside of the rack in seconds, without tools, so your chainsaw is within reach at all times
 - Accommodates any brand electric chainsaw (sold separately)
 - Rubber pads provide cushion and tight fit
 - 6.8 kg weight capacity
- » 2890580

SPORTSMAN 570 '21-'25, SPORTSMAN TOURING 570 '25



QUICKTAP BATTERY POSTS

- Easy-to-access terminal posts give you quick access to the battery power
 - Ideal for charging your battery, powering a temporary accessory, or when you need to offer an unexpected jump-start
 - Connection posts feature covers to protect terminals when not in use
- » 2882110



RECOVERY STRAP

- 5cm x 9.1m (8165 kg)
 - Comes with carry bag
- » 2884033

**TRAILERING AND
ADDITIONAL
STRAPS P. 60**



YOUTH ATV OUTLAW 70 EFI

The perfect first all-terrain vehicle for kids starting at 6 years and older.



FRONT BRUSHGUARD

- Provides enhanced protection from brush and other debris on the trail
- » 2884567

OUTLAW 70 EFI '21-'25



WINDSHIELD - POLY

- Added wind and hand protection with a durable poly design
- » 2885005

OUTLAW 70 EFI '21-'25



REAR BRUSHGUARD

- Protect the rear of your youth ATV on the trails
- » 2884778

OUTLAW 70 EFI '21-'25

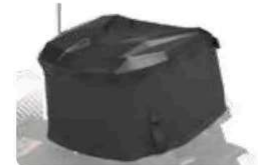

REAR STORAGE BAG

- Convenient storage that easily connects to the rear rack
- » 2884555

OUTLAW 70 EFI '21-'25

SPORTSMAN YOUTH MAINTENANCE PARTS & FLUIDS



POLARIS ENGINEERED PARTS AND OIL have been validated and tested extensively, specifically for your vehicle. In order to maintain the peak performance of your Polaris vehicle only use official Polaris Engineered parts and oil.

ACCESSORIES

570

860 / XP1000
XP1000 S

SCRABBLER
XP1000 S

MISCELLANEOUS
& YOUTH

WINCHES, PLOWS
& TRACKS

LIGHTING

CONNECTED
TECHNOLOGY

HUNT & COOLERS

WHEELS & TIRES
& TRAILERING



DRIVE BELT

- » 3023904
OUTLAW 70 EFI
- » 0453455
OUTLAW 110,
SPORTSMAN 110
- » 0452496
PHOENIX 200



BRAKE PADS

- » FRONT/REAR • 2208176
OUTLAW 70 EFI
- » FRONT • 0455315
OUTLAW 110, SPORTSMAN 110
- » REAR • 0455441
OUTLAW 110, SPORTSMAN 110
- » FRONT • 0454664
PHOENIX 200



OIL FILTER

- » 3023869
OUTLAW 70 EFI
- » 0452462
PHOENIX 200



BATTERY

- » 4010678
OUTLAW 70 EFI
- » 4011181
OUTLAW 110,
SPORTSMAN 110
- » 4011434
PHOENIX 200



AIR FILTER

- » 7082513
OUTLAW 70 EFI
- » 0454620
OUTLAW 110,
SPORTSMAN 110
- » 1253355
PHOENIX 200



SPARK PLUGS

- » 3023835
OUTLAW 70 EFI
- » 0453034
OUTLAW 110
- » 3023835
PHOENIX 200



ENGINE OIL

SEE P. 64 FOR DETAILS



ANGLE DRIVE FLUID 80W/140

- » 1L • 503320
- » 25 L • 503318
- » 200 L • 503317
PHOENIX 200



AGL

- » 1L • 502505
- » 25 L • 502507
- » 200 L • 502508



DOT 4 BRAKE FLUID

- » 250 ML • 502526



ALL-SEASON GREASE TUBE

- » 400 G • 502538

MAINTENANCE SCHEDULE*

BREAK-IN MAINTENANCE

FIRST 10 HRS | 100 MI / 160 KM

- AIR FILTER
INSPECT & CLEAN
REPLACE AS NEEDED
- ENGINE OIL & FILTER
CHANGE
- TRANSMISSION OIL
CHANGE
- DRIVE CHAIN
ADJUST & LUBRICATE

1 MONTH

20 HRS | 200 MI / 320 KM

- BATTERY
CLEAN & TEST
- ENGINE OIL & FILTER
CHANGE

6 MONTHS

50 HRS | 500 MI / 800 KM

- GENERAL LUBRICATION
ALL FITTINGS, PIVOTS,
CABLES, ETC.
- BRAKE PADS
INSPECT
REPLACE AS NEEDED
- DRIVE BELT
INSPECT
REPLACE AS NEEDED

8 MONTHS

60 HRS | 700 MI / 1000 KM

- AIR FILTER
INSPECT & CLEAN
REPLACE AS NEEDED
- SPARK PLUG
INSPECT & CLEAN
REPLACE AS NEEDED

12 MONTHS

100 HRS | 1000 MI / 1600 KM

- TRANSMISSION OIL
CHANGE
- DRIVE BELT
INSPECT
REPLACE AS NEEDED

*This is a sample maintenance schedule. Please reference and use your owners manual for full maintenance and vehicle care.

FOR A COMPLETE
MAINTENANCE
SCHEDULE, CHECK
YOUR OWNER'S MANUAL



ADD A PLOW
P. 42

DEPENDABLE. TOUGH. BUILT FOR THE OFF-ROAD.

A Polaris Engineered winch is designed to help you get the job done right, get you on your way faster and prepare you for the unexpected.

WHY POLARIS?

Polaris Off Road vehicles are engineered with designated mounting points and wiring for seamless install of Polaris Engineered winches.



TESTED **1,200+**
PULLS AT MAX LOAD



BUILT TO WITHSTAND
-29° C TEMPERATURES



OPERATES
FULLY SUBMERGED



MILITARY
TESTED & APPROVED



TOP SELLER
REPLACEMENT SYNTHETIC ROPE
» 2,500 LB • 2878888



REPLACEMENT STEEL CABLE
» 1588 kg LB winch series - 15.2 m
» 2878890

FEATURES & BENEFITS

ALL POLARIS ENGINEERED WINCHES COME WITH:

- ✓ INTEGRATED WIRING, MOUNT, PREASSEMBLED
- ✓ HOOK WITH STRAP
- ✓ CUT STEEL GEARS & SEALED DRIVETRAIN
- ✓ SEALED PERMANENT MAGNET MOTOR



Retrieve cable 5x as fast as standard mode on other Polaris winches. Get back to riding or complete your task quicker.

1. Set winch dial to N (Neutral) to manually pull the rope out and secure the hook to your anchor point
2. Set winch dial to L (Low) for maximum pulling power while winching your load
3. Set winch dial to H (High) for retrieving the rope 5x faster with Rapid Rope Recovery

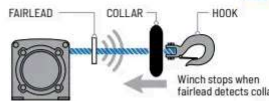

Auto Stop technology protects and extends the life of your winch by automatically stopping the winch at the end of pull to prevent over-spooling. While plowing, it prevents the plow frame from bending by stopping the winch once the plow has been lifted.



With its lightweight, yet extremely strong, design and superior flexibility, this 15.2 m long synthetic rope is easy to handle and can stand up to any tough job.



This convenient remote operates your Polaris winch wirelessly from within 15.2 m of the vehicle. Operate your winch safely outside your vehicle while on the job site or trails.

MODEL

570 '21-25
X2 570 '25
TOURING 570 '25
6X6 570 '25

XP 1000 '15-25
TOURING XP 1000 '15-25

XP 1000 S '20-25
SCRAMBLER XP 1000 S '20-25



TOP-OF-THE-LINE FEATURES
BEST FOR PLOWING, HEAVY-DUTY OUTDOOR CHORES & TRAIL RIDING



BUILT FOR THE OFF-ROAD
BEST FOR THE CASUAL OFF-ROAD RIDER

570

860 / XP-1000
XP 1000 S

SCRAPBLER
XP 1000 S

MISCELLANEOUS
& YOUTH



WINCHES, PLOWS
& TRACKS

LIGHTING

CONNECTED
TECHNOLOGY

HUNT & COOLERS

WHEELS & TIRES
& TRAILERING

PRO HD SERIES		HD SERIES	
✓	✓		
✓	✓	NOT AVAILABLE	
✓	✓	ADD AUTO STOP TECHNOLOGY 	
		2881693 SYNTHETIC ROPE REQUIRED FITS WINCHES: 2880434, 2880432	2889253 SYNTHETIC ROPE REQUIRED FITS WINCHES: 2884832, 2884833, 2889468, 2889470
✓	✓	✓	TOP SELLER ADD SYNTHETIC ROPE 2878888
✓	✓		ADD WIRELESS WINCH REMOTE 2879316
1588 KG WITH SYNTHETIC ROPE		1588 KG WITH SYNTHETIC ROPE	1134 KG WITH STEEL CABLE
2884834		2884833	TOP SELLER 2884832
2889471		2889470	2889469
2883580			



GLACIER PLOW SYSTEMS

TAKE COMMAND OF CLEARING
SNOW AND MAKE QUICK WORK
OF EVEN THE HEAVIEST JOBS.



DRIVE UP



HOOK IN



LOCK DOWN

INSTALLATION

30 seconds: drive up, hook on, lock down, and go – the integrated
Polaris Engineered Glacier Plow System simplifies plowing.

CONVENIENCE

Lift and angle adjustments can
be made from the driver's seat.

ROBUST FRAME

A plow system is only as strong as
its frame, and Polaris Engineered
plow frames have a wide frame to
withstand the rigors of heavy plowing.



DURABLE BLADES

Available in strong stamped steel or corrosion-resistant
poly materials, Polaris Engineered plow blades cover a
large surface area for quick snow removal.

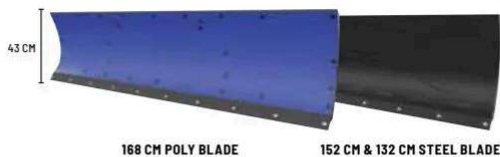

168 CM POLY BLADE

152 CM & 132 CM STEEL BLADE



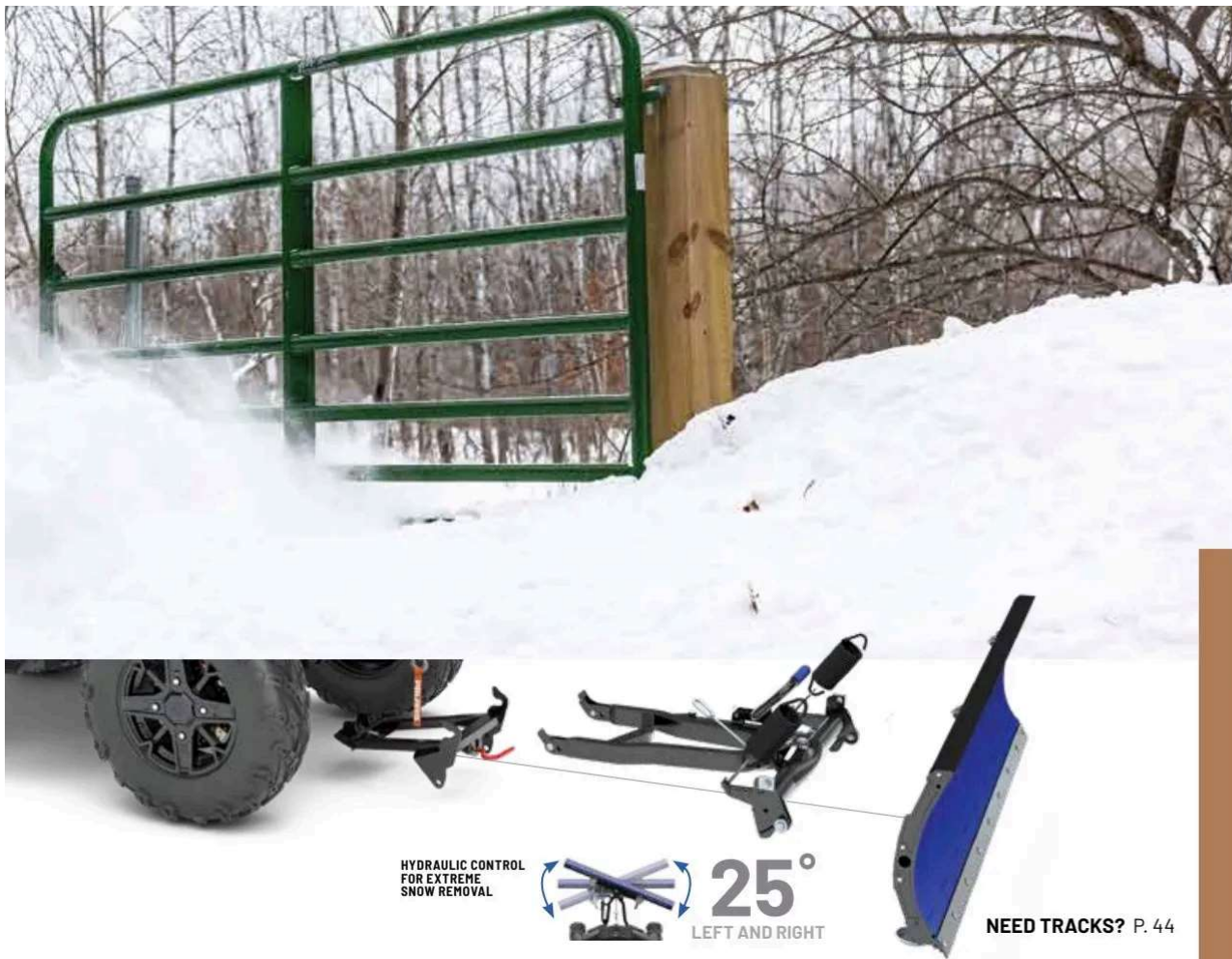

GLACIER PLOW SYSTEMS 168 cm, 152 cm or 132 cm blades Choice of poly or steel Ability to add a hydraulic angle system

MODELS	MANDATORY STEPS			OPTIONAL	
	STEP 1 SELECT A MOUNT	STEP 2 SELECT A FRAME	STEP 3 SELECT PLOW CONFIGURATION		STEP 4 ADD HYDRAULICS
	MOUNT	FRAME	WINCHES	BLADES	HYDRAULICS
XP 1000 '15-25 XP 1000 HIGHLIFTER '16-25 TOURING XP 1000 '15-25	TOP SELLER 2881423		Polaris Pro HD 1,588 kg Winch 2889471 Polaris HD 1,588 kg Winch 2889470 Polaris HD 1,134 kg Winch 2889469		
XP 1000 S '20-25 SCRAMBLER XP 1000 S '20-25	2883581		Polaris Pro HD 1,588 kg Winch 2883580	168 cm Poly 2880269	
6X6 570 '17-25 X2 570 '15-25 TOURING 570 '15-25		TOP SELLER 2879630	TOP SELLER Polaris HD 1,588 kg Winch 2880434 TOP SELLER Polaris HD 1,134 kg Winch 2880432	TOP SELLER 152 cm Steel 2879638 TOP SELLER 132 cm Steel 2879639	Hydraulic Plow Blade Angle System 2879635
570 '15-25 6X6 570 '25 X2 570 '25 TOURING 570 '25	TOP SELLER 2881424		TOP SELLER Polaris Pro HD 1,588 kg Winch 2884834 TOP SELLER Polaris HD 1,588 kg Winch 2884833 TOP SELLER Polaris HD 1,588 kg Winch 2884832		
STEP 5 SELECT ACCESSORIES AND REPLACEMENT ITEMS					
168 cm HD Wear Bar 2879868 168 cm Wear Bar 2879867 152 cm Wear Bar 2877243 132 cm Wear Bar 2877210 152 cm UHMW Wear Bar 2890651 132 cm UHMW Wear Bar 2890652	168 cm Plow Blade Snow Deflector 2879866 152 cm Plow Blade Deflector 2871808 Skid Shoe 2208864 Glacier Pro Shear Pin Replacement 2205063 Coil Spring Spacer 2872655	Plow Winch Rope (for 1,134 kg & 1,588 kg winches) 2878483 Glacier Plow Marker (sold in pairs) 2872726 Rear Tire Chains (recommended for rear tires only) 2881422 Plow Blade Track Extension (required for track equipped vehicles) 2879719			

ALL-TERRAIN TRACTION

It's tough to make Sportsman even more versatile than it already is. But with a set of Prospector Pro Tracks, you'll do just that. Tread through deep snow without concern.



PROSPECTOR PRO 2.0 TRACK SYSTEM

- A** New front dual stabilizer for improved stability
- B** Polaris-specific gearing provides 1:1 ratio to:
 - Minimize track slip, providing better climbing ability and improved traction in deep snow
 - Improve top speed over prior models by approximately 5%
 - Reduce operating RPM for a quieter ride
 - Improve driveline durability, which allows vehicle to run at a lower RPM, decreasing engine wear
- C** Polaris exclusive optimized hub geometry that minimizes feedback and eases steering effort
- D** Lightweight design provides for better flotation, eases steering effort, and provides better vehicle control
- E** Flexible lug design provides the highest level of deep snow performance by lifting up in deep snow as opposed to digging down

STEP 1 SELECT A MOUNT KIT		
MODELS	A-ARMS	MOUNT KIT
XP 1000 ¹⁵⁻²⁵ TOURING XP 1000 ¹⁵⁻²⁵	STRAIGHT	2879457
XP 1000 ¹⁶⁻²⁵ HIGHLIFTER 1000 ¹⁶⁻²⁵	ARCHED	2882109
XP 1000 S ²⁰⁻²⁵ SCRAMBLER XP 1000 S ²⁰⁻²⁵	ARCHED	2883977
570 ²¹⁻²⁵ X2 570 ²⁵ TOURING 570 ²⁵	ARCHED	2889218
570 ²¹⁻²⁵ X2 570 ²⁵ TOURING 570 ²⁵	STRAIGHT	2889219
570 ¹⁴⁻²⁰ TOURING 570 ¹⁵⁻²⁴ X2 570 ¹⁵⁻²⁴	STRAIGHT	2879497

STEP 2 SELECT A TRACK KIT	
MODELS	TRACK KIT
570 ¹⁴⁻²⁵ TOURING 570 ¹⁵⁻²³ X2 570 ¹⁵⁻²⁴ X2 570 ²⁵ TOURING 570 ²⁵	2889493
XP 1000 ¹⁵⁻²⁵ TOURING XP 1000 ¹⁷⁻²⁵ HIGHLIFTER 1000 ¹⁶⁻²⁵ XP 1000 S ²⁰⁻²⁵ SCRAMBLER XP 1000 S ²⁰⁻²⁵	2889495

WANT TO PLOW?

GLACIER PRO PLOW TRACK EXTENSION

- Plow extension for use when using the Prospector Pro Track System and Glacier Pro Plow System

» 2879719

FOR USE WITH GLACIER PRO PLOW SYSTEMS





SPORTSMAN SNOW TRACTION OPTIONS

ACCESSORIES

570

860 / XP 1000
XP 1000 S

SCRABBLER
XP 1000 S

MISCELLANEOUS
& YOUTH

WINCHES, PLOWS
& TRACKS

LIGHTING

CONNECTED
TECHNOLOGY

HUNT & COOLERS

WHEELS & TIRES
& TUBING

TREAD THROUGH SNOW WITH THESE OPTIONS	CONTACT PATCH	TURNING RADIUS
 <p>STOCK TIRES</p>	 <p>GOOD</p>	<p>354.3 CM</p> 
 <p>PRO ARMOR WHITEOUT</p>	 <p>BETTER</p> <p>More surface area for better flotation on snow</p>	<p>352.743 CM</p> 
 <p>PROSPECTOR PRO 2.0 TRACKS</p>	 <p>BEST</p> <p>Less aggressive tread displaces snow for better handling</p>	<p>445.453 CM</p> 



POLARIS ENGINEERED ADVANTAGES

MOUNTS PERFECTLY
Designed for your Polaris Engineered bumper, roof or other mounting point

ADVANCED TECH

RIGID lights are driven by Aluminum PCB Smart Boards, 6063-T5 aircraft aluminum extruded housings and Tiger Drylac UV protection polyester powdercoating.

EXCLUSIVE OPTICS

RIGID lights feature impact-resistant polycarbonate lenses for a 100% water/dustproof seal.



LIGHT BAR TYPES



SR-SERIES PRO

Sleek, powerful, low-profile (under 5 cm tall). Lights extreme distances with low energy usage.

Available in 25.4 cm Flood, Spot & Combo



D-SERIES PRO

Compact to fit almost anywhere with high output and low energy usage.

Available in Driving, Flood & Spot

OPTICS

DRIVING

FLOOD

LIGHT BAR OPTIONS

1,200 m
960 m
720 m
480 m
240 m

BRAND SIZE
TYPE
RAW LUMENS
PN

RIGID POD
D-SERIES
4,752
2883128*
Comes in a pair

RIGID 25.4 CM
SR-SERIES
7,920
2883122*

RIGID POD
D-SERIES
3,168
2883126*
Comes in a pair

RIGID 25.4 CM
SR-SERIES
7,920
2883121*

BUILD YOUR VISION

Consider the optics, angle and how you will use your vehicle to choose the right light or set of lights.

OPTICS LIGHT ANGLE	ACCENT	DRIVING (45°)	FLOOD (25°)	SPOT (10°)	COMBO (25°/10°)
DRIVING SPEED	All	Slow to medium	Slow to medium	High	All
BEAM	Diffused glow	Extra-wide	Wide/shorter	Concentrated/long	Inner spot & outer flood
RECOMMENDED MOUNTING	Low/wheel well	All points	Low/rear	High points	All points
TERRAIN & RIDING STYLE	Added style & personalization in any terrain	All riding & utility	Wide-open terrain or trails & utility	Trail & tight conditions	All riding & utility

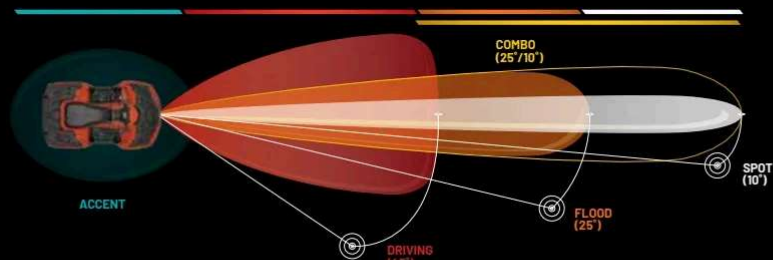

MAX PERFORMANCE

Validated to work as hard as your machine does

DOESN'T OVERTAX

Trust it to work when you need it to

PRO ARMOR



RUGGED CONSTRUCTION

Pro Armor lights are designed to be big and beefy with an aggressive style all their own, and housed in IP67 marine-grade rated UV polyester powdercoating.

MASSIVELY BRIGHT

Pro Armor builds bright lights designed for any riding experience. All that power is directed through heat dissipating aluminum for streamlined heat management.



SINGLE-ROW LED

Powerful, compact, low-profile light bars with sleek look.



CUBE LED

Small size allows mounting in strategic locations for added lighting.

Available in Spot

ACCESSORIES

570

860 / XP1000
XP1000 S

SCRABBLER
XP1000 S

MISCELLANEOUS
& YOUTH

WINCHES, PLOWS
& TRACKS

LIGHTING

CONNECTED
TECHNOLOGY

HUNT & COOLERS

WHEELS & TIRES
& TRAILERING

SPOT

COMBO

OPTICS

1,200 m
960 m
720 m
480 m
240 m



RIGID POD

D-SERIES
3,168

2883127*

Comes in a pair

PRO ARMOR CUBE

DUAL-ROW
1,500

2889794

2889795

RIGID 25.4 CM

SR-SERIES
7,920

2883123*

BRAND SIZE

TYPE
RAW LUMENS

PN

*Not available in Europe

POLARIS ENGINEERED

LED LIGHT KIT

• Upgrade your standard headlights and pod lights to LEDs with this upgrade kit

» 2884859

SPORTSMAN XP 1000 S '21-25,
SPORTSMAN 1000 '21-25,
SPORTSMAN 570 '21-25

DOES NOT WORK WITH MODELS PRIOR TO '21
U.S. MODELS ONLY



LIGHTBAR HARNESS

• Control one light with one switch

» 2882320

ALL SPORTSMAN MODELS

LED Y-HARNESS

• Requires 2882320 to control two cubes or two lights with one switch

» 2879860

ALL SPORTSMAN MODELS

CONNECTED TECHNOLOGY

GO REMOTE.
STAY CONNECTED.

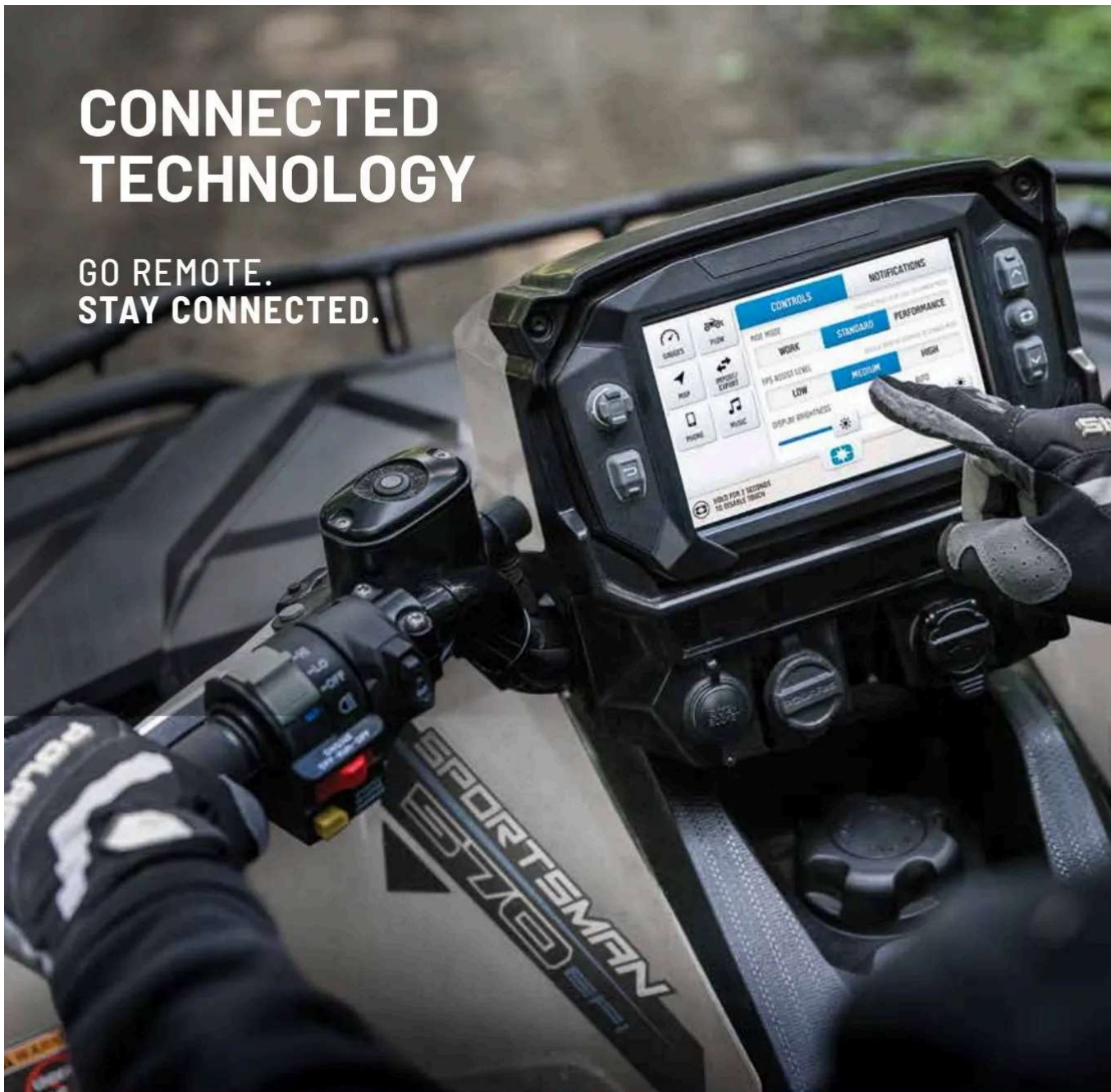

POLARIS RIDECOMMAND

PLAN YOUR RIDE

Plan an epic ride with stops along the way and ensure you're on a marked trail with Snap-to-Trail technology. Later, share your route with friends so you can hit the trails together.

WORK SMARTER

Plow Mode automatically raises and lowers the plow depending on the gear you're in so that you can get your work done quicker.

DISCOVER NEW TRAILS

With over 1,000,000 miles of trails available offline, you'll have the confidence to explore further, whether you have cellular coverage or not.



- ACCESSORIES
- 570
- 860 / XP 1000
XP 1000 S
- SCRABBLER
XP 1000 S
- MISCELLANEOUS
& YOUTH
- WINCHES, PLOWS
& TRACKS
- LIGHTING
- CONNECTED
TECHNOLOGY

7" DISPLAY POWERED BY RIDE COMMAND

Industry-leading 7" display with glove-touch compatibility and visible in all conditions.

Configurable Gauges

Customize your ride experience with elevation, travel direction, fuel level and more to create relevant screens for you.

» 2889455

SPORTSMAN 570 '22-25, SPORTSMAN 1000 '22-25, X2 570 '25, 6X6 570 '25, TOURING 570 '25
FOR OFF-ROAD USE ONLY ON TRACTOR VERSION

Personalized Audio Experience

Seamlessly pair to your display via Bluetooth to wirelessly stream music and stay connected with call and text alerts. Add the Lock & Ride Rear Audio Storage Box to stream music. (Requires Lock & Ride Rear Audio Storage Box and Rear Power Harness.)

Industry-Exclusive Plow Mode

Quick and easy plowing. Plow automatically lowers when shifted into low gear and raises when shifted into reverse. (Requires Polaris Winch with Auto Stop Technology and Synthetic Rope. Learn more on P. 40)

7" Display Mount Kit Included

Comes with required wiring harnesses and accessory components. Includes V2V and GPS antenna.

- HUNT & COOLERS
- WHEELS & TIRES
& TRAILERING

HUNT



**PROTECTING YOUR
ESSENTIAL GEAR
SINCE 1943**



KOLPIN STRONGHOLD SYSTEM

Polaris is proud to partner with Kolpin Outdoors, an industry leader in off-road accessories and the premier name in gun boots and mounts. If you need to secure a firearm while riding, simply attach the auto-latch mount and choose your gun boot.

IDEAL FOR SECURE TRANSPORT OF SCOPED RIFLES AND SHOTGUNS.

STEP 1 CHOOSE YOUR MOUNT

STEP 2 CHOOSE YOUR BOOT



KOLPIN STRONGHOLD AUTO-LATCH MOUNT

- The auto-latch provides quick and secure attachment of Kolpin Stronghold Gun Boots
- Bracket is made from rugged high impact, reinforced nylon and coated steel with precision angle adjustment for a custom fit
- For use with Kolpin Stronghold Gun Boots (sold separately)

» 2882272

SPORTSMAN 1000 '17-'25

DOES NOT FIT WITH ULTIMATE SERIES BODY ARMOR (2882080)



KOLPIN STRONGHOLD AUTO-LATCH MOUNT TOP SELLER

- The Auto-Latch provides quick and secure attachment of Kolpin Stronghold Gun Boots
- Bracket is made from rugged high impact, reinforced nylon and coated steel with precision angle adjustment for a custom fit
- For use with Kolpin Stronghold Gun Boots (sold separately)

» 2884846

TOURING 570 '25, SPORTSMAN TOURING 570 '25,
SPORTSMAN 570 '21-'25



KOLPIN STRONGHOLD GUN BOOT L

- 132.1 cm L x 12.1 cm W x 23.5 cm H
- Requires Auto-Latch Mount 2882272 or 2884846 to mount to vehicle

» 2882426

SPORTSMAN 1000 '17-'25, TOURING 570 '25,
SPORTSMAN 570 '14-'25



Never transport a loaded firearm. Verify firearm is unloaded prior to mounting. Please refer to local laws and regulations regarding the requirements for the legal transport of firearms.



KOLPIN STRONGHOLD GUN BOOT XL TOP SELLER

- Lockable and TSA Approved
- Includes padded, zippered internal protective liner
- 132.1 cm L x 9.5 cm W x 26.6 cm H
- Requires Auto-Latch Mount 2882272 or 2884846 to mount to vehicle

» 2882036
XP 1000 17-25, TOURING 570 '25, 570 '19-25



KOLPIN RHINO GRIPS

IDEAL FOR CARRYING RIFLES, SHOTGUNS, BOWS AND CROSSBOWS.

LR RHINO GRIP PRO – ATV

- » 2884119
- » REPLACEMENT RUBBER STRAPS • 2884109
ALL SPORTSMAN MODELS (EXCEPT UTILITY EDITIONS & YOUTH)



LR RATCHETING RHINO GRIP – ATV TOP SELLER

- » 2881157
ALL SPORTSMAN MODELS (EXCEPT UTILITY AND YOUTH)



LR RHINO GRIP XLR – ATV

- » 2889147
- » REPLACEMENT RUBBER STRAPS (2) • 2889204
ALL SPORTSMAN MODELS (EXCEPT UTILITY EDITIONS & YOUTH)



LR RHINO GRIP XLR – DOUBLES – ATV

- » 2889148
- » REPLACEMENT RUBBER STRAPS (2) • 2889204
ALL SPORTSMAN MODELS (EXCEPT UTILITY EDITIONS & YOUTH)



All Kolpin Rhino Grips are Lock & Ride compatible and come with required mounting hardware.

ADDITIONAL STORAGE OPTIONS

KOLPIN GUN BOOT IV

- For 50mm scopes, rifles with slings attached, or shotguns up to 129.54 cm in length
- » BLACK • 2872677

REQUIRES MOUNT 2878001 TO MOUNT TO SPECIFIC SPORTSMAN MODELS



LR GUN BOOT MOUNTS

- Works with Lock & Ride XL Storage Box, Lock & Ride Rear Cargo Box, and Rear Rack Extenders

» 2878001
SPORTSMAN 1000 TOURING '10-25
 ONLY COMPATIBLE WITH KOLPIN GUN BOOT IV - NOT COMPATIBLE WITH KOLPIN STRONGHOLD GUN BOOTS



ACCESSORIES

570

860 / XP 1000
 XP 1000 S

SCRABBLER
 XP 1000 S

MISCELLANEOUS
 & YOUTH

WINCHES, PLOWS
 & TRACKS

LIGHTING

CONNECTED
 TECHNOLOGY

HUNT & COOLERS

WHEELS & TIRES
 & TRAILERING

COOLERS



MADE FOR RIDERS.
BUILT FOR LIFE.

28, 57 & 99 LITER FEATURES

- Comfort Carry Handles
- TravelLock System
- EasyOut Drain System
- NoSlip Rubber Feet
- PolarWall Insulation
- IceLock Seal



99 LITER

SAGEBRUSH GREEN • 2890707
GRAPHITE • 2883426

ACCESSORIES

- WIRE BASKET • 2883648
- DIVIDER (1) • 2883468
- WHEELS • 2883967

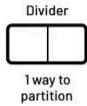

57 LITER

SAGEBRUSH GREEN • 2890706
GRAPHITE • 2883425

ACCESSORIES

- WIRE BASKET • 2882185
- DIVIDERS (2) • 2882184
- SEAT CUSHION • 2882179
- WHEELS • 2882180



28 LITER

SAGEBRUSH GREEN • 2890705
GRAPHITE • 2883424

ACCESSORIES

- WIRE BASKET • 2882438
- DIVIDER (1) • 2882186



ESSENTIAL ACCESSORIES SO YOUR COOLER WORKS AS HARD AS YOU DO





POLARIS NORTHSTAR COOLERS CAN SURVIVE JUST ABOUT ANYTHING - FROM EXTREME HEAT TO A NASTY TUMBLE OFF A VEHICLE.



14 LITER
SAGEBRUSH GREEN • 2890704
GRAPHITE • 2883968



**19 LITER
SOFT-SIDED COOLER**
GRAPHITE • 2889285



HOLDS ICE FOR AGES

BECAUSE JUST ANY COOLER WON'T CUT IT OUT THERE.

You need something rugged and reliable. A cooler purpose-built to handle the challenges of the off-road—while keeping your provisions on ice for days on end. Because out here, there are no ice machines, and you just left the last one in your dust. So, load it up. Lock it in. And know your NorthStar cooler is staying put—giving you a few extra days of ice time to enjoy the wild.

WHEELS & TIRES



PRO ARMOR

OFF-ROAD, IT'S ALL ABOUT FREEDOM & CREATING YOUR OWN PATH

As serious riders ourselves, we get it. And everything we design is to get (and keep) you going on the ride of a lifetime. We're for every style of rider looking to go beyond the expected with a ride that will make your story epic.





WHY CHOOSE PRO ARMOR?

SUPERIOR PERFORMANCE & DURABILITY

LIFELONG PERFORMANCE

- Every tire is designed and constructed with **longevity** in mind
- **3,000+ mile rated** (4,828 kilometers)

PREMIUM PROTECTION

- Pro Armor makes tires with **extra protection** exactly where it's needed most – the sidewall
- **Triple-belted sidewalls** keep your tires more resistant so you can keep going
Many competitors only use double-belted sidewalls

TOUGH TIRES

- Higher ply ratings mean added protection
- Pro Armor builds 8 or 10-ply rated tires for **higher puncture-resistance**

For off-road use only. Please check fitment with your dealer.



TIRES

Developed and tested with Polaris engineers, ensuring the perfect fit and optimal performance mile after mile.



PRO ARMOR PRESERVE

Turf-friendly for areas requiring low-impact from treads.

Why Choose Preserve?

Perfect for locations where you don't want to risk damaging turf.

PRO ARMOR XD-K

These heavy duty tires are one of the strongest we've ever built. Superior puncture resistance, ride quality and long life.

Why Choose XD-K?

Triple-belted sidewall resists puncture.

PRO ARMOR HARVESTER

Designed for trail & agricultural applications with excellent grip, minimal crop impact and long wear life.

Why Choose Harvester?

Great for unexpected impact and rugged terrain.



PRO ARMOR X TERRAIN - E-MARKED

Handle anything the trail throws your way, with a durability-driven design that provides a comfortable and confident ride.

Why Choose X Terrain?

Triple-belted sidewall resists puncture.

PRO ARMOR TREKKER

The best balance of on-trail handling and low tire noise.

Why Choose Trekker?

Ultimate predictability with a quiet ride.

DUAL-DUROMETER

PRO ARMOR DUAL-THREAT

Dual compound technology for superior grip and traction.

Why Choose Dual-Threat?

Softer outer lugs for cornering grip and feel; harder inner lugs for longer tread life.



PRO ARMOR ATTACK

Aggressive tread design provides traction in any environment.

Why Choose Attack?

Great all-season tire with wider lug spacing for grip in softer terrain.

PRO ARMOR WHITEOUT

Engineered to charge through snow with unprecedented flotation and traction.

Why Choose Whiteout?

More surface area for better flotation on snow.



DUAL-COMPOUND

PRO ARMOR MUD XC

The best tread design that balances aggressive traction in the mud with a smoother ride on the trail.

Why Choose Mud XC?

Perfect mud-trail crossover.



PRO ARMOR TIRES HAVE BEEN DEVELOPED AND TESTED to ensure the perfect fit, superior durability and optimal performance, mile-after-mile. No matter where you ride - mud, dirt, sand or snow - we've got you covered.

KNOW YOUR TERRAIN



- Tread patterns optimized for extreme traction
- Ideal for both hard pack & loose trail



- Provides traction & durability
- Performs in hard sand, jagged rocks or any extreme terrain



- Flexible "grippy" tread
- Aggressive side bite



- Extra deep treads
- Self-cleaning lugs



- Triple-belted sidewalls to resist puncture
- Purpose-built, long lasting tread patterns



- Handles extreme cold
- Holds shape & provides traction

WHEELS



BEADLOCK REQUIRED

BEADLOCK INCLUDED

INNER AND OUTER BEADLOCK INCLUDED



40-SERIES

A 4101

WEIGHT: 6.6 kg	LOAD RATING: 363 kg	OFFSET: -35
MATTE BLACK	FRONT/REAR	14" x 10"
		1522958

D 4203 BEADLOCK

FRONT WEIGHT: 5.9 kg	LOAD RATING: 408 kg	OFFSET: +4
REAR WEIGHT: 6.6 kg	LOAD RATING: 590 kg	OFFSET: -9
MATTE BLACK	FRONT	14" x 7"
	REAR	14" x 8"
		1522238-458
		1522239-458

G 4206

FRONT WEIGHT: 4.3 kg	LOAD RATING: 408 kg	OFFSET: +4
REAR WEIGHT: 4.9 kg	LOAD RATING: 590 kg	OFFSET: -9
MATTE BLACK	FRONT	14" x 6"
	REAR	14" x 8"
		1522542-458
		1522543-458

B 4201

FRONT WEIGHT: 5.9 kg	LOAD RATING: 408 kg	OFFSET: +9
REAR WEIGHT: 6.4 kg	LOAD RATING: 590 kg	OFFSET: +9
ACCENT	FRONT	14" x 7"
	REAR	14" x 8"
		1522956-266
		1522957-266
MATTE BLACK	FRONT	14" x 7"
	REAR	14" x 8"
		1522956-458
		1522957-458

E 4204

FRONT WEIGHT: 5.9 kg	LOAD RATING: 408 kg	OFFSET: +4
REAR WEIGHT: 6.4 kg	LOAD RATING: 590 kg	OFFSET: -9
ACCENT	FRONT	14" x 7"
	REAR	14" x 8"
		1522546-266
		1522547-266
MATTE BLACK	FRONT	14" x 7"
	REAR	14" x 8"
		1522546-458
		1522547-458

H 4301 BEADLOCK

WEIGHT: 7.3 kg	LOAD RATING: 726 kg	OFFSET: +38
ACCENT	FRONT/REAR	14" x 7"
		1523284
MATTE BLACK	FRONT/REAR	14" x 7"
		1523283

C 4202

FRONT WEIGHT: 5.8 kg	LOAD RATING: 408 kg	OFFSET: +4
REAR WEIGHT: 6.1 kg	LOAD RATING: 590 kg	OFFSET: -9
ACCENT	FRONT	14" x 7"
	REAR	14" x 8"
		1522544-266
		1522545-266
MATTE BLACK	FRONT	14" x 7"
	REAR	14" x 8"
		1522544-458
		1522545-458

F 4205

FRONT WEIGHT: 4.8 kg	LOAD RATING: 408 kg	OFFSET: +4
REAR WEIGHT: 5.7 kg	LOAD RATING: 590 kg	OFFSET: -9
MATTE BLACK	FRONT	14" x 7"
	REAR	14" x 8"
		1521507-521
		1521508-521
LUSTER	FRONT	14" x 7"
	REAR	14" x 8"
		1521507-410
		1521508-410

I HD DUAL BEADLOCK

WEIGHT: 18.1 kg	LOAD RATING: 725.7 kg	OFFSET: +38
MATTE BLACK	FRONT/REAR	14" x 7"
		1524022-458

14" FORGED BEADLOCK RINGS

MACHINED 1522244-266

ONLY USED ON 4203 BEADLOCK & HD DUAL BEADLOCK
SOLD INDIVIDUALLY



MATTE BLACK 1523146-458

ONLY USED ON 4301 BEADLOCK & HD DUAL BEADLOCK
SOLD INDIVIDUALLY



KNOW YOUR WHEELS

STEP 1: SELECT YOUR SERIES

4 = 40-SERIES

STEP 2: CHOOSE YOUR LOAD RATING

1 = <362.9 kg 2 = 363 - 589.7 kg 3 = 590 - 726+ kg

STEP 3: PICK YOUR STYLE

OFFSET / BEADLOCK / COLOR

INCREASE OFFSET FROM STOCK = NARROWER STANCE
DECREASE OFFSET FROM STOCK = WIDER STANCE

2 WAYS TO PURCHASE

INDIVIDUAL WHEELS & TIRES
- OR -
COMPLETE SETS AS LISTED

Exclusively at Polaris Authorized Dealers

KNOW YOUR TERRAIN



- Tread patterns optimized for extreme traction
- Ideal for both hard pack & loose trail



- Extra deep treads
- Self-cleaning lugs



- Triple-belted sidewalls to resist puncture
- Purpose-built, long lasting tread patterns



- Handles extreme cold
- Holds shape & provides traction

WHEEL & TIRE SETS

14" 40-SERIES

	TRAIL				MUD	UTILITY		SNOW
	TREKKER 27"	X TERRAIN 27"	ATTACK 26"	DUAL-THREAT 26"	MUD XC 27"	PRESERVE 27"	HARVESTER 27"	WHITEOUT 27"
4101 ○ MATTE BLACK								2882382
4201 ○ ACCENT		2889966	2882390	2883138	2884272	2883208	2882388	
4201 ○ MATTE BLACK		2889967	2882391	2883139	2884273	2883209	2882389	
4202 ○ ACCENT	2890907	2889968	2881335	2883140	2884267		2882383	
4202 ○ MATTE BLACK	2890905	2889969	2881336	2883141	2884268	2883204	2882384	
4203 BEADLOCK ○ MATTE BLACK <small>BEADLOCKS SOLD SEPARATELY</small>		2889972	2881381					
4204 ○ ACCENT		2889973	2881347	2883142	2884270	2883205	2882385	
4204 ○ MATTE BLACK		2889974	2881348	2883143	2884271		2882386	
4205 ○ LUSTER			2881359	2883144				
4205 ○ MATTE BLACK		2889975	2881360	2883145	2884269	2883207	2882387	
4206 ○ MATTE BLACK			2881404					
4301 BEADLOCK ACCENT <small>BEADLOCKS PRE-MOUNTED</small>		2889970		2883217				
4301 BEADLOCK MATTE BLACK <small>BEADLOCKS PRE-MOUNTED</small>		2889971		2883216				

LUG NUTS
○ Lug Nuts Required



METRIC LUG NUTS FOR ALUMINUM RIMS
 » SET OF 4 • 2877385
 » SET OF 16 • 2877384
SPORTSMAN XP

SAE LUG NUTS FOR ALUMINUM RIMS
 » SET OF 4 • 2876754
 » SET OF 16 • 2877409
SPORTSMAN 570

COLBY VALVE SHORT ULTIMATE VALVE - 2 PACK
 » 2883292



COLBY VALVE EMERGENCY VALVE - 2 PACK
 » 2883293



COLBY COMBO VALVE KIT - 16 PACK
 • Includes eight Ultimate Valves and eight Emergency Valves
 » 2883294
ORDERABLE THROUGH LOCAL DEALER ONLY



570

860 / XP1000 XP1000 S

SCRABBLER XP1000 S

MISCELLANEOUS & YOUTH

WINCHES, PLOWES & TRACKS

LIGHTING

CONNECTED TECHNOLOGY

HUNT & COOLERS

WHEELS & TIRES & TRAILERING

CLEANERS

CLEAN

ALL-PURPOSE CLEANER

• Professional cleaner, which is formulated with a low pH-value. The product spreads well on surfaces and adheres on them for effective cleaning action. Perfectly compatible with rubber, plastic and painted surfaces. The formulation is biodegradable.

» 500 mL • 502309

SHINE

INSTANT SHINE & DETAILER

• The INSTANT SHINE AND DETAILER is developed for cleaning action without water. Removes insects, dust and dirt with almost no effort. Applicable for plastics, visors, windscreens, paint and metal. The wipe and shine formulation makes surfaces shine, works water repellent and also has an antistatic effect. Perfect for customers living in urban areas with no access to water, for bike trips or showroom bikes.

» 500 mL • 502546



TRAILERING

RAMPS



CALIBER RAMP PRO

- Designed for ATVs and UTVs up to 127 cm wide
- Integrated grip glides for ultimate traction
- Folding sides for easy transportation and storing

» 132 CM × 229 CM • 2884576



ALUMINUM ARCHED LOADING RAMPS

- Capacity for up to 1,361 kg
- » 193 CM × 30.5 CM • 907 KG • 2875384
- » 224 CM × 30.5 CM • 1,361 KG • 2875386



LIGHTWEIGHT TRI-FOLD RAMPS

- Ramp folds up for transport
- Capacity for up to 680.7 kg
- Safety straps included
- » 183 CM × 130 CM • 2875385
- » 208 CM × 130 CM • 2875860



FOLDING ALUMINUM ARCHED RAMPS

- Ramp folds up for transport
- Up to 680 kg total capacity, 340 kg per individual ramp
- Safety straps included
- » 224 CM × 30.5 CM • 2875387

COVERS

TRAILERABLE COVER

» 2876614
SPORTSMAN 570,
SPORTSMAN 1000
REPLACEMENT STRAP 2871912

» 2877999 (SHOWN)
ALL SPORTSMAN TOURING
REPLACEMENT STRAP 2871912



CV BOOT REPAIR KIT*

FIX ON THE GO | TEMPORARY COVERAGE

- A quick trail-side fix to increase trail time
- The flexible and durable boot material expands over a cone tool for CV boot repairs, without disassembling CV axles
- Universal fit – works as a temporary fix for most powersports axles
- All components fit inside the cone, and a cover is provided for compact durable storage
- Easily fits in a cargo box, attached to the roll cage, in the glovebox or many other storage locations



Items shown are contained inside cone

ATV CV BOOT REPAIR KIT

Kit includes the following items:

- (1) Expandable CV Boot
 - (1) Reusable Cone Tool
 - (2) CV Boot Clamps
 - (1) Tube of Silicone Lube
 - (1) Grease Packet
 - (1) Cone Cover
- » 2830528

ATV TRAIL BOOT ONLY

» 2830529

UTV

- » CV REPAIR KIT 2830526
- » TRAIL BOOT ONLY 2830527

HOW TO INSTALL

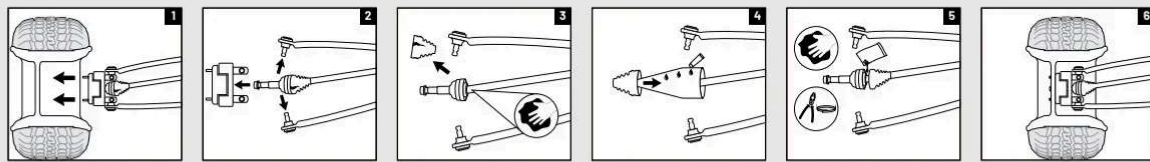

1 Remove wheel and axle nut.

2 Remove brake caliper, hub, tie rod and upper and lower ball joints.

3 Remove old boot and clean joint.

4 Spread silicone lube on entire cone tool. Slide boot over cone tool, large end first. See package for outer boot instructions.

5 Empty the bag of grease into the CV joint/boot, clean sealing points and install clamps.

6 Reassemble tie rod, ball joints, brake caliper, axle nut, tire and wheel.

Refer to your service manual for further instructions and torque specifications.
*Designed for temporary CV boot repair. Purchase the OEM CV Boot for a permanent repair.

HITCHES



HITCH WITH 5 CM BALL

- 3:1 Hitch: ball, hook and pin design
 - Rust resistant steel with powdercoat finish
 - Removable ball, HD 1.6 cm pin and clip
- » 5 CM x 5 CM RECEIVER • 2830522
» 3 CM x 3 CM RECEIVER • 2830523



4.8 CM BALL

- 4.8 cm replacement ball for hitch
 - Designed to work with 3:1 Hitch
- » 2830524



RECEIVER HITCH

- » 5 CM RECEIVER TONGUE 2875320



TRAILER BALL 1.9 CM SHANK

- » 4.8 CM BALL • 2877602
- » 5 CM BALL • 2877603

STRAPS & ROPES



RECOVERY STRAP

- 5 cm x 9.1 m
 - 8,165 kg maximum load, 4,082 kg maximum vehicle weight
 - Comes with carry bag
- » 2884033



RATCHET STRAP

- 3.8 cm x 4.6 m straps, 2 pack
 - Heavy duty webbing
 - 2,495 kg maximum load, 831 kg working load
- » 2884031



RATCHET STRAP

- 5 cm x 6.1 m
 - Heavy duty webbing, floating D-rings, double J-hooks
 - 4,536 kg maximum load, 1,497 kg working load
- » 2884032



SHOCK STRAPS

- 3.8 cm 1,361 kg breaking strength
 - Keeps tension on tie-down straps to secure load, 2 pack
- » 3.8 CM x 4.6 M • 2883296
» 3.8 CM x 2.1 M • 2883295

ACCESSORIES

570

860 / XP1000 XP1000 S

SCRABLER XP1000 S

MISCELLANEOUS & YOUTH

WINCHES, PLOWS & TRACKS

LIGHTING

CONNECTED TECHNOLOGY

HUNT & COOLERS

WHEELS & TIRES & TRAILERING



MAINTENANCE & GARAGE

FACTORY APPROVED. Every Polaris vehicle has been engineered and manufactured to deliver performance. Keep it that way by using the same lubricants, cleaners and service parts our factory-trained technicians use.



MAINTENANCE & GARAGE

OIL & LUBRICANTS

JUMP STARTERS & SERVICE PARTS



OIL & LUBRICANTS

Our PS-4 engine oils provide ultimate performance and protection, they're formulated with exclusive additives to keep engines clean from deposit buildup. These powersports-grade full synthetic oils helps maximize power and protect your engine for the long term.

**PS-4 FORMULATIONS
BEST PROTECTION,
BEST PERFORMANCE**

PS-4 5W-50 FULL-SYNTHETIC OIL

Optimal for ambient operating temperatures of -40° C to 38° C.

1L	4L	25L	60L	200L
502484	502485	502486	502487	502488

PS-4 0W-50 EXTREME FULL-SYNTHETIC OIL

Optimal for ambient operating temperatures of -43° C to 54° C.

1L	4L	25L	» 60L	» 200L
503220	503221	503233	503236	503235

OIL CHANGE KITS

These convenient kits include everything needed including filter and oil volume per vehicle

PART NUMBER	VEHICLE FITMENT
502541	SINGLE 570, TWIN 600, TWIN 700, TWIN 800
502543	RANGER/RZR/GENERAL 900/1000
502542	SPORTSMAN 570/1000

POLARIS INVESTS IN EACH OIL AT & ABOVE THESE LEVELS

**12+ DEDICATED
TEAM MEMBERS**

FOCUSED ON POLARIS OIL

**18+
MONTHS**

DEVELOPMENT & TESTING

**76,000+
HOURS**

DYNO TESTING

**3.5 MILLION+
KILOMETERS**

FIELD TESTING



**DOT 4
BRAKE FLUID**

A high-quality brake fluid designed for use in Polaris hydraulic brakes.
» 250 ML • 502526



**ALL-SEASON
GREASE TUBE**

Specialized water-resistant lubricant
» 400 G • 502538



**PREMIUM GAS
SHOCK OIL**

» 1L • 502518



AGL

Protects transmission components against wear, corrosion, oxidation and foam in transmissions.

» 1L • 502505
» 25 L • 502507
» 200 L • 502508



POLARIS
EXTREME
SYNTHETICS

PS-4 EXTREME SYNTHETIC 0W-50

- Our best extreme high and low temp formula, excellent for high temperatures and racing, even at temps of 54°C, plus easier cold starting even below -42°C
- Expect the best in wear protection thanks to premium PAO and ester base stocks combined with a balance of moly and ZDDP additives
- Polaris exclusive clean engine additive system reduces deposits and carbon build-up for peak performance and power

THE BEST PROTECTION, MAXIMUM PERFORMANCE

- Powersports grade full synthetics provide long lasting engine protection
- At least 40% improved wear protection compared to all aftermarket oils tested (see engine wear test chart)
- Polaris exclusive clean additive system
- At least 50% less deposits than all aftermarket oils tested (see deposit test chart)
- Cleaner engine with less deposits means consistent maximum power and performance

WIDEST VISCOSITY FOR ULTIMATE PROTECTION



ENGINE WEAR TEST

LOWER NUMBER = LESS ENGINE COMPONENT WEAR
LESS WEAR ON PARTS MEANS LONGER ENGINE LIFE

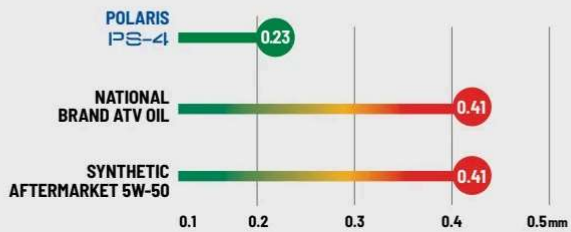

ASTM D4172. In 3rd party testing against 9 competitive products Polaris had 40% or better wear protection compared to all of the tested products. Numbers represent mm of wear scarring measured. Test measures wear at contact points, wear scar is measured for its length and width (in units of mm). Lower wear numbers mean better wear protection and friction reduction.

DEPOSIT TEST

LOWER DEPOSITS = MAXIMUM POWER

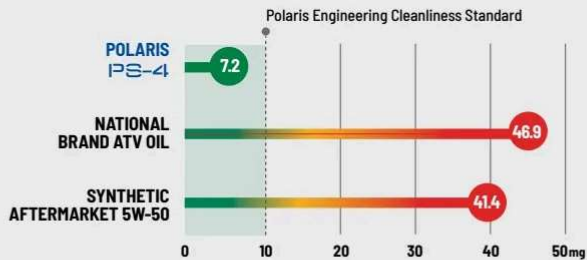

ASTM D6335. In 3rd party testing against 9 competitive products Polaris PS-4 had less than half the deposits compared to the next closest product. No other tested products met Polaris Engineering standards for deposit cleanliness. Test measures mass of deposits in mg in high temp, high stress test cycles. Higher deposits will impact engine power and performance.



DEMAND DRIVE FLUID

Proprietary formulation prevents clutch slippage and chatter and reduces component wear and corrosion.

- » 1 L • 502563
- » 25 L • 502564
- » 200 L • 502565



ANTI-FREEZE

Prevent corrosion on metal components, eliminate scaling and maximize cooling system performance.

- » 1 L • 502566
- » 25 L • 502567
- » 206 L • 502568



CARBON CLEAN

Ultimate fuel and injection system cleaner.

- » 125 ML • 502528



FUEL STABILIZER

Fuel Stabilizer prevents ethanol corrosion and stabilizes fuel for up to 2 years. Dual-antioxidant formula protects against gum and varnish for easy starting.

- » 125 ML • 502519
- » 355 ML • 2882519

JUMP STARTERS



NOCO BOOST® GB40 12V 1000A JUMP STARTER

- Delivers 1,000 amps for jump starting a dead battery in seconds
- » 2830547



NOCO BOOST® GB70 12V 2000A JUMP STARTER

- Delivers 2,000 amps for jump starting a dead battery in seconds
- » 2830597



NOCO BOOST® JUMP PACK PROTECTION CASES

- Lightweight, durable and rugged custom exterior
- » GB40 • 2830548
- » GB70 • 2830598

YOUR BATTERY IS READY WHEN YOU ARE

SERVICE PARTS



POLARIS ENGINEERED SERVICE PARTS DELIVER UNMATCHED PERFORMANCE AND FIT FOR YOUR OFF-ROAD VEHICLE.

All service parts are engineered specifically for your machine. Which means everything is designed, tested and perfected to maximize the life of your ride. Getting Polaris Engineered parts is a decision that pays off in the long run, because there is a long run.

VISIT YOUR POLARIS DEALER TO SHOP FOR SERVICE PARTS.

FOR THE LIFE OF YOUR RIDE

Maintenance is the key to keeping your Polaris off-road vehicle performing at its peak. Items like belts, lubricants, and batteries represent only a few of these critical items engineered specifically by Polaris.



TESTED, PERFECTED

We test each belt on the intended vehicle - we don't just try to make an existing belt "just work".

- Amery,
Polaris System Engineer

POLARIS ENGINEERED DRIVE BELTS

OUR INVESTMENT

- 32,187 km of field testing
- Thousands of dyno hours
- 18+ months of development (3,000+ design hours) per belt
- 1,200+ vehicle validation hours
- Collaboration with powertrain & clutch engineers

YOUR ADVANTAGE

- No clutch recalibration
- Less wear & tear due to heat
- Ensure maximum performance of your vehicle
- More time out riding, less time wrenching

OUR INVESTMENTS ENSURE POLARIS BELTS OUTPERFORM YOUR EXPECTATIONS.



APPAREL

FIT FOR ANY ADVENTURE. For outdoor enthusiasts looking for gear that's purposefully built to stand up to the fun and challenging experiences Polaris vehicles enable. Each piece of apparel and equipment bearing the name Polaris is crafted by outdoor enthusiasts, for outdoor enthusiasts. They are a badge of honor - representing what the Polaris brand stands for - a passion to simply be outside doing what you love.

JERSEYS, GLOVES & GAITERS



APPAREL

JERSEYS, GLOVES & GAITERS

RACING COLLECTION

CASUALWEAR & HATS

HOME & COLLECTIBLES

HELMETS & GOGGLES



WHITE/BLUE
Adult | 2865376

TAN/ORANGE
Adult | 2865377
Youth | 2865382

FUCHSIA/GRAY
Adult | 2865379
Youth | 2865381

TEAL/LIME
Adult | 2865378

BLACK
Adult | 2865374

BLUE
Adult | 2865375
Youth | 2865380

NEW
THROTTLE JERSEYS

ADULT: S-3XL
YOUTH: S-XL

- Mesh ventilated panels for maximum airflow
- Elastic sleeves with non-restrictive cuffs



WHITE/BLUE
Adult | 2865385

TAN/ORANGE
Adult | 2865386
Youth | 2865391

FUCHSIA/GRAY
Adult | 2865388
Youth | 2865390

TEAL/LIME
Adult | 2865387

BLACK
Adult | 2865383

BLUE
Adult | 2865384
Youth | 2865389

NEW
THROTTLE GLOVES

ADULT: S-3XL
YOUTH: S-XL

- Adjustable wrist closure for a custom fit
- Silicon finger grips and neoprene knuckle protection
- Gloves are not CE-approved



BLUE
2833138

LIME
2861952

CAMO
2861948

BLACK
2861953

RED RETRO
2861950

NECK GAITERS

- Keep the sun off your neck and the dust off your face
- Stretchy and seamless material
- UPF 15-18 for sun protection and moisture-wicking

RACING COLLECTION



HELMET

- Polycarbonate shell
- Removable & washable lining
- Double lens system with integrated sun visor
- Quick release micrometric adjustment system

Black Matte | XS-2XL | 2802408
 White Gloss | XS-2XL | 2802311
 Dark Gray Matte | XS-2XL | 2802312



- Weight: 1450 g (+/-50 g)
- 1 shell and 2 EPS: XS-M, L-XXL
- ECE 22-06 approved



SPORT JACKET

- Light and water repellent jacket
- Ideal for ATV and SxS ride in wet weather
- 2 zipped pockets on the outside and 2 inside pockets
- Laser cut under the arms for better ventilation

Black | XS-4XL | 2802409



SPORT PANTS

- Light and water repellent pant
- Ideal for ATV and SxS in wet weather
- Ergonomic cut and stretch to gain comfort
- 1 zipped pocket
- Belt adjustment with micrometric buckle

Black | XS-4XL | 2802410



BOOTS

- Waterproof and breathable lining
- Full-grain oil treated leather upper
- Specific ATV double density compound rubber sole
- Adjustable Velcro® closure
- Replaceable/adjustable plastic buckles
- Anti-bacterial replaceable footbed
- CE-approved motorcycle boots EN 13634:2017

Black | EU39 - 47 | 2802313
 Brown | EU39 - 47 | 2802314



TECHNICAL SHIRT

- 100% polyester
- Indelible sublimated graphics
- Hemmed edging
- Lycra cuffs and collar

Men's | Black | S-3XL | 2802404
 Women's | White | S-2XL | 2802405



SAFETY GLOVES TOUCH



- CE-approved motorcycle glove EN 13594:2015
- Touch screen compatible
- Silicon print on fingers to improve grip
- Neoprene cuff with Velcro® tightening
- Reinforcements patches for safety and comfort

Khaki | S-3XL | 2802309
 Black | XS-7, 3XL-13 | 2802103



NEO GLOVES



- CE-approved motorcycle glove EN 13594:2015
- 100% synthetic neoprene glove
- Touch screen compatible
- Knuckle protected
- Reinforcements patches for safety and comfort

Black | XS-7, 3XL-13 | 2802310



SF TECH GLOVES TOUCH



- CE-approved motorcycle glove EN 13594:2015
- Touch screen compatible
- Knuckle-protected
- Silicon print on fingers to improve grip
- Neoprene cuff with Velcro® tightening
- Reinforcements patches for safety and comfort

Khaki | S-3XL | 2802308
 Black | XS-7, 3XL-13 | 2802102



NEW
HYBRID HOODIE

- Sporty sweatshirt with padded front
- 80g quilted front
- Hood and sleeves in interlock knit

Black | S-3XL | 2800325



NEW
PACKABLE PUFFER JACKET

- Lightweight packable padded down jacket
- Suitable for mid-season or as a mid-layer
- Packable in a practical pouch provided
- Can be easily stored in your vehicle
- Main material 100% polyamide
- Insulation 100% polyester

Dark Blue | S-3XL | 2800125



WATERPROOF JACKET

- 100% polyester 2.5 Layer stretch fabrics
- PU membrane waterproof and breathable 3000 mm / 3000 gr
- All seams taped and WR main zipper
- Adjustable hood
- Ventilation system on back to improve ventilation

Black | S-3XL | 2802403



NEW
PUFFY JACKET 2.0

- Top body and shoulder polyester woven 3000 mm/3000 gr + welded quilting
- Lower body nylon 380T downproof
- 80gr padding
- Inner elastic bottom tightening
- Two external pockets with easy-grab puller

Black | S-3XL | 2800725



PADDED JACKET

- Shoulder and hood softshell waterproof and breathable 3000 mm/3000 gr
- Lower body and sleeve, polyester woven waterproof and breathable 3000 mm/3000 gr
- Quilted lining with 80 gr padding
- Elasticized lower body tightening
- Two external pockets with easy-grab puller

Black | S-3XL | 2802306



NEW
PADDOCK RAINCOAT

- Waterproof rain coat made of polyester fabrics with PVC coating on outside
- All seam are high frequency welded
- Raglan sleeve shape
- Two front patch pocket with flaps
- Front opening with snaps

Black | M/L, XL/XXL | 2800425



BODYWARMER

- Upper body and side panels in softshell waterproof and breathable 3000 mm/3000 g
- Lower body nylon downproof
- Padding 80 g
- Two external pockets with easy-grab puller

Khaki | S-3XL | 2802304
Black | S-3XL | 2802101



RACING SOFTSHELL

- Softshell waterproof and breathable 3000 mm/3000 g
- Removable hood
- Four external pockets with easy-grab puller

Women's | Black | S-XL | 2802402
Men's | Khaki | S-3XL | 2802305
Men's | Black | S-3XL | 2802003



HYBRID JACKET

- Sleeves in softshell waterproof and breathable 3000 mm/3000 g
- Body nylon downproof
- Padding 80 g
- Three external pockets with easy-grab puller

Khaki | S-3XL | 2802401
Black | S-3XL | 2802004

CASUALWEAR & HATS



NEW
SOFTSHELL JACKET 2.0

- | | |
|----------------------|------------------------|
| MEN'S S-3XL | WOMEN'S S-3XL |
| Black 2865318 | Black 2865343 |
| Rust 2865319 | Blue 2865344 |
| Blue 2865320 | |

PURSUIT HOODIE

- | | |
|----------------------|---------------------------|
| MEN'S S-3XL | WOMEN'S S-3XL |
| Orange 2864606 | NEW Camo 2865488 |
| Camo 2862494 | |
| Black 2833076 | |
| Green 2833077 | |

NEW
RANGE WORK JACKET

- | | |
|----------------------|------------------------|
| MEN'S S-3XL | WOMEN'S S-3XL |
| Black 2865321 | Black 2865345 |
| Tan 2865322 | Tan 2865346 |



PLAID FLANNEL SHIRT

- | | |
|-------------------------------|-------------------------------|
| MEN'S S-3XL | WOMEN'S S-3XL |
| NEW Cabernet 2865495 | NEW Cabernet 2865496 |
| Blue 2864671 | Blue 2864673 |
| Cypress 2864672 | Teal 2864674 |



NEW
PERFORMANCE SHIRT

- | |
|----------------------|
| MEN'S S-3XL |
| Sand 2865497 |
| Cypress 2865498 |



PIT SHIRT TOP SELLER

- | |
|----------------------------|
| MEN'S SIZE VARIES |
| Cypress S-3XL 2864561 |
| Black XS-4XL 2862526 |
| Navy S-3XL 2833043 |



ELLIPSE PATCH TRUCKER HAT

- | | |
|-------------------|------------------|
| Purple 2864563 | Black 2833500 |
| Cypress 2864562 | Navy 2833499 |
| Gray 2833498 | Orange 2833124 |



CORE CAP TOP SELLER

- | |
|-----------------|
| Red 2833123 |
| Gray 2833507 |
| Navy 2833494 |
| Black 2833495 |



SHIELD PATCH CAP

- | |
|----------------|
| Navy 2864578 |
| Red 2864579 |



STAPLE CAP TOP SELLER

- | |
|-----------------------------|
| NEW Maroon 2865516 |
| Cypress 2864568 |
| Black 2833127 |
| Navy 2833128 |



STEALTH CAMO CAP

- | |
|----------------|
| Camo 2861527 |
|----------------|



HUNTER ORANGE HAT

- | |
|----------------|
| S/M 2860892 |
| L/XL 2862545 |



TONAL HAT

- | |
|---------------------|
| Orange 2864564 |
| Black/Red 2833497 |
| Navy 2833496 |



CORE BEANIE

- | |
|------------------|
| Orange 2862595 |
|------------------|

HOME & COLLECTIBLES



POLARIS KEY RACK
30.5 cm x 20 cm | 2864718



POLARIS LED SIGN
61 cm x 26.7 cm | 2862736



POLARIS RACING LED SIGN
61 cm x 22.9 cm | 2862737



ALUMINUM SIGN
55.9 cm | 2860867



WOOD SIGN
61 cm x 26.7 cm | 2860866



POLARIS STEEL SIGN
91.4 cm x 35.6 cm | 2860868



POLARIS PARKING SIGN
2869934



POLARIS FLAG
152 cm x 91.4 cm | 2869928



DECK OF CARDS
2860816



POLARIS PVC COASTERS
2864715



POLARIS NOTEBOOK
2860831



LEATHER KEY CHAINS
Leather Loop | 2861615
Black Leather | 2861616



PADDOCK UMBRELLA
2800625



HITCH COVER
2861623



LICENSE PLATE HOLDER
2862687

APPAREL

JERSEYS, GLOVES & GAITERS

RACING COLLECTION

CASUALWEAR & HATS

HOME & COLLECTIBLES

HELMETS & GOGGLES

HELMETS



**CARBON FIBER
BLACK**
S-2XL | 2833158



DELTA V COMMANDER

NO LONGER A HELMET, IT'S A COCKPIT

S-2XL

SHELL

- Carbon fiber
- Lightweight polycarbonate

WEIGHT

- Up to 1,832 g

FEATURES

- The Delta V Commander features an integrated communication system, infinity style sealed IGNITE heated shield, and ergonomic design
- Features in-helmet JBL® speakers for audio and an integrated microphone to connect up to 14 users in a group with the best sound and noise cancellation for all your rides
- Venturi Vent Ducting, an integrated spoiler, and low-profile antennae keeps this helmet sleek, quiet, and fog-free all day on the trails
- 12-volt power input on left side powers shield, comms, and chase light with controls for bright, normal, and off positions
- Battery power for up to 10 hours of riding
- Connect via Bluetooth™ to your music, phone, maps, and sled
- DOT/ECE 22.06 dual certified helmet shell and luxurious liner
- Fidlock® chinstrap for easy on and off



BLACK
2833151



WHITE
2833150



TEAL/LIME
2865411



NEW

TACTICAL 3.0 MTN

EXPERIENCE TOP-TIER PROTECTION, COMFORT, AND CONNECTIVITY IN THE MOUNTAINS

XS-4XL

SHELL

- Poly and ABS Polymer Construction - ensures both strength and a lightweight feel for maximum protection

WEIGHT

- Starting at 1,300g

FEATURES

- Venturi Vent system generates negative pressure at velocity and pulls moist air from the breath box
- Cardo® UCS Compatibility - integration and easy assembly of Cardo® UCS modules (sold separately)
- Magnetic Fidlock® chin-strap technology
- Plush liner design
- Compatible with VEES Protection System (sold separately) for cold days
- DOT-and ECE 22.06-approved



BLUE
2865412

RETRO
2865409

BLACK
2865408

V.E.E.S. LINER
2865412

GOGGLES



74

POLARIS



NEW
FUCHSIA/GRAY
2865427

509 KINGPIN



FEATURES

- Built for off-road, the oversized spherical lens delivers optimal peripheral vision
- Metal tear-off posts provide strength and durability
- Quick-change technology allows you to run the best lens tint for conditions



OLIVE/LIME
2864546

STEALTH
2862560

NEW
BLUE/WHITE
2865428



NEW
MAROON/FUCHSIA
2865435

TENACITY 4.0

COMBINATION OF MODERN STYLE & PREMIUM PROTECTION WITH INCREDIBLE VALUE

XS-2XL

SHELL

- Shock-resistant, injection-molded thermoplastic

WEIGHT

- 1,500g

FEATURES

- Through-flow, full-helmet ventilation
- ProClip quick release chin strap allows you to fasten the chin strap in seconds
- Removable breath box and removable, washable liner
- Tool-less adjustable roost shield
- DOT/ECE 22.06 dual certified helmet shell



BLACK
2865418

FOR
POLARIS FIDLOCK.

NEW

YOUTH TACTICAL 3.0

EMPOWER THE NEXT GENERATION OF RIDERS WITH CUTTING EDGE TECH

S-L

SHELL

- Poly and ABS Polymer construction ensures both strength and a lightweight feel for maximum protection

FEATURES

- Venturi Vent system generates negative pressure at velocity and pulls moist air from the breath box
- Cardo® UCS Compatibility - integration and easy assembly of Cardo® UCS modules (sold separately)
- Plush liner design
- Magnetic Fidlock® chin-strap technology to enable faster securing and removing of the helmet
- DOT-and ECE 22.06-approved



NEW
GRAY/BLUE
2865434



BLACK/LIME
2864560



BLACK
2864859



TEAL/LIME
2865420



NEW
TEAL/LIME
2865430

509 MX6



FEATURES

- PC outer lens with anti-scratch coating, and internal anti-fog coating
- Outriggers with latch system for quick lens change
- 45mm strap with silicone to hold strap in place



NEW
TEAL/LIME
2865429

YOUTH RIPPER



FEATURES

- Excellent visibility
- Anti-fog performance
- Scratch resistant durability



ORANGE
2864545

BLACK
2862557

NEW
BLUE
2865431



CRUISER BLACK
2864549

FORGE YOUR OWN PATH



POLARIS
Think Outside

Availability varies by market, check your local dealer for availability. Images taken on private land. The use of vehicles in similar environments in your jurisdiction may be prohibited per locally applicable laws and regulations. Campfires in similar environments in your jurisdiction may be prohibited per locally applicable laws and regulations. Keep your campfire safe, and make sure you can control it at all times. Know your locally applicable laws and regulations. Crossing water in similar environments may be prohibited in your jurisdiction.

Warning: Polaris Off Road vehicles can be hazardous to operate and are not designed for on-road use. Driver must be at least 16 years old with a valid driver's license to operate. All riders should always wear helmets, eye protection and protective clothing and footwear. Read, understand and follow your owner's manual. Ride within the limits of your own abilities and never engage in stunt or exhibition driving. Never ride under the influence of drugs or alcohol. All riders should take a safety training course.

Unless noted, trademarks are the property of Polaris Industries Inc. 509® is a registered trademark of Teton Outfitters, LLC. App Store® is a registered trademark of Apple Inc. Bluetooth® is a registered trademark of Bluetooth Sig, Inc. Caliber® is a registered trademark of Caliber, Inc. Cardo® is a registered trademark of Cardo Systems, Inc. Facebook™ is a service trademark of Facebook, Inc. Fidlock® is a registered trademark of Fidlock GmbH. FOX® is a registered trademark of Fox Factory Inc. Google Play™ is a service trademark of Google LLC; and YouTube® is a registered trademark of Google LLC. GoPro® is a registered trademark of GoPro Inc. Instagram™ is a service trademark of Instagram, LLC. MORFLEX® is a registered trademark of FNA Group, Inc. NOCO Genius® and NOCO Boost® are registered trademarks of The Noco Company. OGIO® is a registered trademark of OGIO International, Inc. RHINO-RACK® is a registered trademark of Rhino Rack Australia Pty Limited. RIGID® is a trademark of JST Performance, LLC d/b/a Rigid Industries, LLC. Rockford Fosgate® is a registered trademark of Rockford Corporation. SMART BOARD® is a registered trademark of Smart Technologies LLC. Unlimited Liability Corporation Canada. Tiger Drylac® is a registered trademark of Tiger Coatings GmbH & CO. KG. Velcro® is a registered trademark of VELCRO IP HOLDINGS LLC. Twitter™ is a service trademark of X CORP. Fitment and availability are subject to change at any moment. Copyright © 2024 Polaris Industries Inc. All rights reserved.

MY25 SPTSMN APP ACC - EMEA